

DOCUMENT 19.7.3

Historic Need Case (2016)

National Grid (North Wales Connection Project)

*Regulation 5(2)(a) of the Infrastructure Planning
(Applications: Prescribed Forms and Procedure) Regulations 2009*

First published October 2016

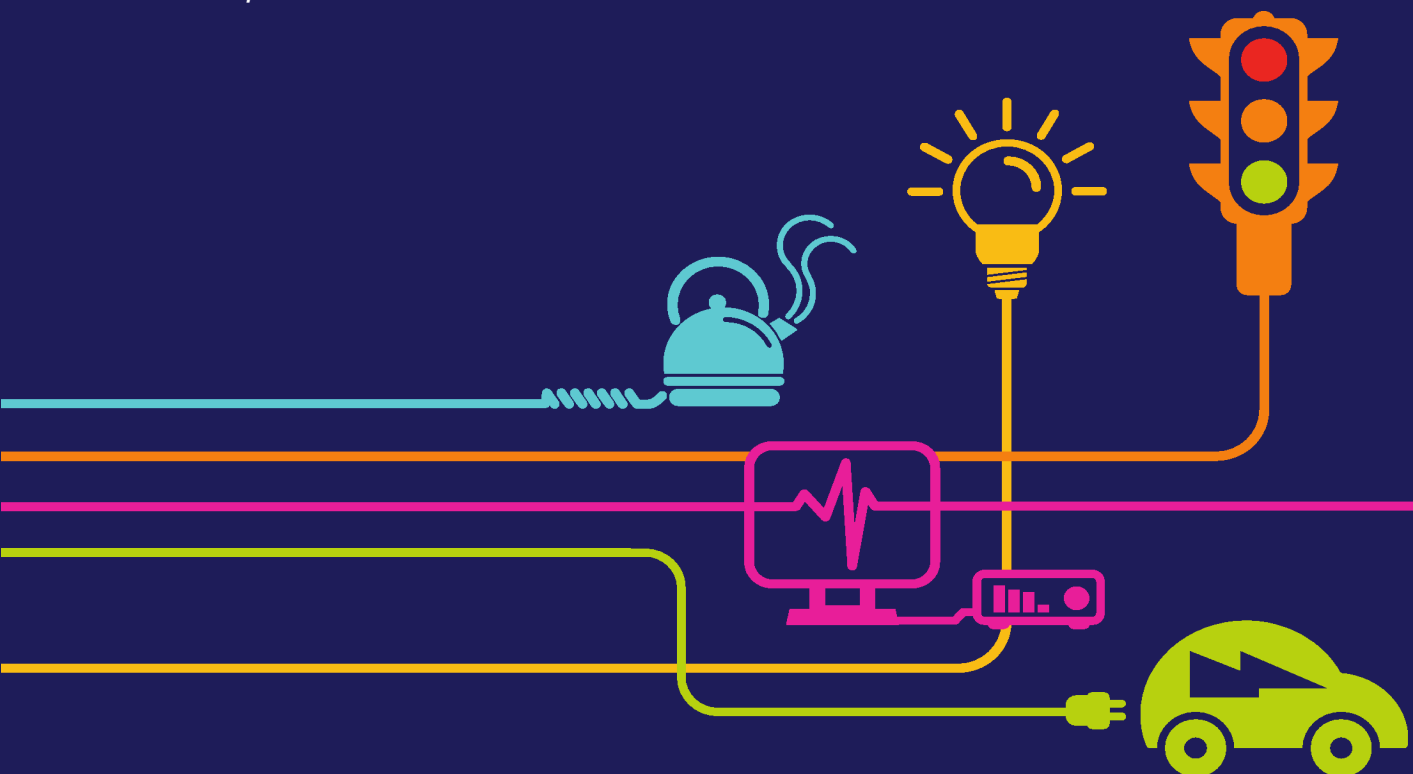



North Wales Connections Project

Project Need Case

National Grid
National Grid House
Warwick Technology Park
Gallows Hill
Warwick
CV34 6DA

October 2016

Table of Contents

1	Introduction	1
2	Background	3
3	Existing Transmission System in North Wales	9
4	Customer Requirements	16
5	Need for Transmission System reinforcement in North Wales.....	19
6	Conclusions	25
	Appendix A – Summary of National Grid Legal Obligations	26
	Appendix B – Transmission System Analysis Principles	29
	Glossary of Terms and Abbreviations	44

1 Introduction

1.1 This Report (the “2016 Need Case”) updates the assessment of the capacity requirements for the electricity transmission system in North Wales. The assessment of need is reviewed periodically in the light of changes to the contracted generation background and demand data. The previous assessment, documented in the “2015 Need Case”, is now superseded.

1.2 The need for changes to the transmission system in North Wales remains, driven by the requirement to connect and export the power from new generation in North Wales.

1.3 This Report takes into account the current contracted generation background and demand data impacting on the transmission system. It documents the findings of the assessment by National Grid Electricity Transmission plc (“National Grid”) that in the coming years there will not be sufficient capacity available on the existing transmission system to meet customers’ requirements.

1.4 This document and other information regarding the North Wales Connections Project, can be found on the National Grid website at

<http://www.northwalesconnection.com/>

1.5 This Report provides:

- An overview of the electricity industry; National Grid’s role; National Grid’s existing transmission system; drivers for changes to transmission system customer requirements, and the impact that changes to customer requirements can have on transmission system development needs (Section 2).
- A summary of the customer connection applications in North Wales (Section 3).
- A description of the transmission system infrastructure in North Wales and the transmission system analysis boundaries that National Grid identified (Section 4).
- Summary details of the results of National Grid’s assessment of the capability of the transmission system available to meet the customer requirements (Section 5).
- The main conclusions that National Grid has reached (Section 6).

1.6 This Report also includes appendices that contain more detailed information. The appendices provide:

- A summary of National Grid's legal obligations that are particularly relevant to this Need Case document (Appendix A).
- An overview of transmission system analysis principles including details of compliance requirements, key assessment criteria, factors that limit transmission system capability, possible consequences of exceeding capability limits and references to generic options for enhancing transmission system capability (Appendix B).
- A glossary of terms and abbreviations used in this Report.

2 Background

Overview of the Electricity Industry

- 2.1 A single electricity market serves the whole of Great Britain. In this competitive, wholesale market generators and suppliers trade electricity on a half hourly basis. Generators produce electricity from a variety of fuel sources, including coal, gas, nuclear and wind, and sell electricity produced in the wholesale market. Suppliers purchase electricity in the wholesale market and supply to end customers.
- 2.2 Generation of electricity at a power station of 100 MW or greater capacity, in Great Britain and its offshore waters, requires permission by a generation licence¹. Generation licensees are bound by legal obligations that are set out in the Electricity Act and the generation licence.
- 2.3 Electricity is transported via network infrastructure from locations where it is generated to demand centres where it is used. In England and Wales, network infrastructure is classed as transmission if operated at a voltage:
- i. above 132 kV, or
 - ii. at 132 kV or above where used to transport electricity from a power station located offshore.
- 2.4 Transmission of electricity in Great Britain requires permission by a licence granted under Section 6(1)(b) of the Electricity Act² 1989 ("the Electricity Act"). National Grid has been granted a transmission licence and is therefore bound by the legal obligations, which are primarily set out in the Electricity Act and the transmission licence. A summary³ of relevant legal obligations is set out in Appendix A. National Grid is the operator of the high voltage transmission system for Great Britain and its offshore waters, which is known as the National Electricity Transmission System (the

¹ A generation licence granted under Section 6(1)(a) of the Electricity Act 1989 (the "Electricity Act").

² The Electricity Act 1989: <http://www.legislation.gov.uk/ukpga/1989/29/contents>

³ The Summary is not intended as an exhaustive list of National Grid's legal obligations but seeks to provide information about the obligations that are particularly relevant to the Report.

"NETS"), and is the owner of the high voltage transmission system in England and Wales⁴.

- 2.5 Distribution systems operate at 132 kV and below in England & Wales and are mainly used to transport electricity from the NETS to the majority of end customers.
- 2.6 Electricity can also be traded on the single market in Great Britain by generators and suppliers in other European countries. Interconnectors with transmission systems in France, Northern Ireland and the Netherlands are used to import electricity to and/or export electricity from the NETS.

National Grid's Existing Transmission System

- 2.7 The existing transmission system was developed to transport electricity in bulk from power stations to demand centres. Much of National Grid's transmission system was originally constructed in the 1960s. Incremental changes to the transmission system have subsequently been made to meet increasing customer demand and to connect new power stations and interconnectors⁵ that connect transmission systems in other countries.
- 2.8 National Grid's transmission system consists of approximately 7,200 km of overhead lines and a further 700 km of underground cabling, operating at 400 kV and 275 kV. In general, 400 kV circuits have a higher power carrying capability than 275 kV circuits. These overhead line and underground cable circuits connect between around 340 substations forming a highly interconnected transmission system. Further details of the transmission system including geographic and schematic representations are published by National Grid annually as part of its Electricity Ten Year Statement⁶ ("ETYS").
- 2.9 Circuits are those parts of the system used to connect between substations on the NETS. The system is composed of double-circuits (in the case of overhead lines carried on two sides of a single pylon) and single-circuits. Substations provide points

⁴ The transmission network in Scotland is owned by SP Transmission Limited in southern and central Scotland and by Scottish Hydro-Electric Transmission Limited in the north of Scotland. Offshore transmission networks will be owned by transmission licensees following the grant of new licences by Ofgem.

⁵ Interconnectors can be used to transfer electricity to and from the NETS.

⁶ Electricity Ten Year Statement: <http://www2.nationalgrid.com/UK/Industry-information/Future-of-Energy/Electricity-Ten-Year-Statement/>

of connection to the NETS for power stations, distribution networks⁷, transmission connected demand customers (e.g. large industrial customers) and interconnectors.

Requirement for Changes to Electricity Network Infrastructure

- 2.10 Six National Policy Statements for energy infrastructure were designated by the Secretary of State for Energy and Climate Change in July 2011⁸. The Overarching National Policy Statement for Energy (“EN-1”) sets out that it is critical that the UK continues to have secure and reliable supplies of electricity as part of the transition to a low carbon economy. EN-1 also highlights an urgent need for new electricity transmission and distribution infrastructure to be provided⁹.
- 2.11 National Policy Statement for Electricity Networks Infrastructure (“EN-5”) explains circumstances where applications for consent for new electricity network infrastructure developments may be considered without an accompanying application for a generating station¹⁰. EN-5 states *“new lines will have to be built, and the location of renewable energy sources and designated sites for new nuclear power stations makes it inevitable that a significant proportion of those new lines will have to cross areas where there is little or no transmission infrastructure at present, or which it may be claimed should be protected from such intrusions”*. EN-5 also explains that the need for a transmission project can be assessed on the basis of contracted generation or reasonably anticipated future requirements.
- 2.12 National Grid is required to provide an efficient, economic and coordinated transmission system in England and Wales. The transmission system infrastructure needs to be capable of maintaining a minimum level of security of supply as defined

⁷ Distribution Networks operate at voltages from 132 kV down to 230 V (at which voltage, the power is distributed to domestic consumers).

⁸ DECC website : http://www.decc.gov.uk/en/content/cms/meeting_energy/consents_planning/nps_en_infra/nps_en_infra.aspx

⁹ Paragraph 3.7.10 of EN-1 : https://www.gov.uk/government/uploads/system/uploads/attachment_data/file/47854/1938-overarching-nps-for-energy-en1.pdf

¹⁰ Paragraph 2.3.3 of EN-5 : https://www.gov.uk/government/uploads/system/uploads/attachment_data/file/47858/1942-national-policy-statement-electricity-networks.pdf

within the National Electricity Transmission System Security and Quality of Supply Standards (NETS SQSS¹¹) and of transporting electricity from and to customers.

- 2.13 National Grid is required to ensure that its transmission system remains capable as customer requirements change. National Grid's customers make decisions in respect of developments that require connection to and/or use of the NETS and in respect of which developments will be taken forward. These customer decisions are influenced by the parameters set by Government¹² as well as other commercial factors (including the works required to connect to the NETS).
- 2.14 The NETS needs to cater for demand changes. The locations of demand centres are broadly constant and in general, demand increases annually. National Grid prepares demand forecasts for each connection point on an annual basis. These forecasts take account of forecast information that is provided to National Grid by its customers, as well as new demand connection requests and other economic factors.
- 2.15 Part of National Grid's role is to provide the contractual interface with demand customers, generators and interconnectors that are seeking to connect to and that are connected to the NETS. National Grid is also required to provide the contractual interface with customers that are exporting power or seeking to export power onto the NETS. A site specific use of system agreement with National Grid is required for each customer connection to the NETS which exports power onto the NETS. In addition, generation that is connected to a distribution system may be required to or choose to contract with National Grid for rights to export power onto the NETS.
- 2.16 One aspect of National Grid's role of providing a contractual interface with customers seeking to use or using the NETS, is to respond to each customer application with an offer for new or modified connection to the NETS. The offer needs to include a connection date, connection location and also define any transmission system reinforcement works that are needed so that the connection can be made.
- 2.17 For any new connection (demand, generation or interconnector), the number of changes needed to the NETS are dependent on the:
- i. distance of the new connection from the existing NETS;

¹¹ NETS SQSS v 2.2: <http://www2.nationalgrid.com/UK/Industry-information/Electricity-codes/SQSS/The-SQSS/>

¹² Energy policy information is available from the Department of Energy and Climate Change website: <https://www.gov.uk/government/topics/energy>

- ii. capability of the part of the existing NETS that is closest to the new connection point, and
 - iii. capacity on the existing NETS that is (or is expected to be) available when the connection is made.
- 2.18 National Grid is required¹³ to connect new generation to the NETS before all transmission system reinforcement requirements that may be required for compliance with the minimum design criteria in the NETS SQSS are completed, provided that the compliance issues can be managed without adverse impact on security and quality of supply.
- 2.19 Recently, a large volume of applications have been made to National Grid for connection of new generation at locations that are remote from the existing transmission system or in the vicinity of parts of the transmission system that does not have sufficient capacity available for the new connection. The majority of these applications have been for low-carbon generation projects. Areas that are rich in low-carbon energy sources are often in locations that are remote from existing transmission system infrastructure.

National Grid Transmission System Development

- 2.20 National Grid has a statutory duty to develop and maintain an efficient, coordinated and economical system of electricity transmission under Section 9 of the Electricity Act. These duties, which are documented in more detail in Standard Licence Conditions¹⁴, are included as part of the summary of legal obligations in Appendix A of this report.
- 2.21 Schedule 9¹⁵ of the Electricity Act 1989 requires National Grid, when formulating proposals for new lines and other works, to:

“...have regard to the desirability of preserving natural beauty, of conserving flora, fauna, and geological or physiographical features of special interest and of protecting sites, buildings and objects of architectural, historic or archaeological interest; and

¹³ A transmission licence obligation was introduced by Government in 2010 to facilitate timely connections for new, generation projects.

¹⁴ A consolidated version of the standard conditions of the electricity transmission licence is available from Ofgem’s electronic public register at : <http://epr.ofgem.gov.uk/Pages/EPRSearch.aspx>

¹⁵ Section 38 of the Electricity Act states that Schedule 9 shall have effect.

*shall do what [it] reasonably can to mitigate any effect which the proposals would have on the natural beauty of the countryside or on any such flora, fauna, features, sites, buildings or objects”.*¹⁶

2.22 National Grid's Stakeholder, Community and Amenity Policy¹⁷ (“the Policy”) sets out how the company will meet the duty to the environment placed upon it. These commitments include:

- i. only seeking to build new lines and substations where the existing transmission infrastructure cannot be upgraded technically or economically to meet transmission security standards;
- ii. where new infrastructure is required seek to avoid areas nationally or internationally designated for their landscape, wildlife or cultural significance, and
- iii. minimising the effects of new infrastructure on other sites valued for their amenity.

2.23 The Policy also refers to the application of best practice methods to assess the environmental impacts of proposals and identify appropriate mitigation and/or offsetting measures. Effective consultation with stakeholders and the public is also promoted by the Policy.

2.24 In addition to the above Policy, National Grid has published a document¹⁸ that seeks to further describe National Grid's approach to the design and routeing of new electricity transmission lines. The document describes the process by which National Grid delivers its projects and also seeks to inform stakeholders of the stages it will take before finally submitting a planning application for development.

¹⁶ Schedule 9 of the Electricity Act: <http://www.legislation.gov.uk/ukpga/1989/29/contents>

¹⁷ National Grid's Commitment's when undertaking works in the UK : <http://www2.nationalgrid.com/UK/In-your-area/Community-Engagement/>

¹⁸ Our approach to the design and routeing of new electricity transmission lines: <http://www2.nationalgrid.com/UK/In-your-area/Community-Engagement/>

3 Existing Transmission System in North Wales

3.1 The transmission system in North Wales is illustrated in the map in Figure 3.1. It shows the transmission substations and the transmission routes joining them.

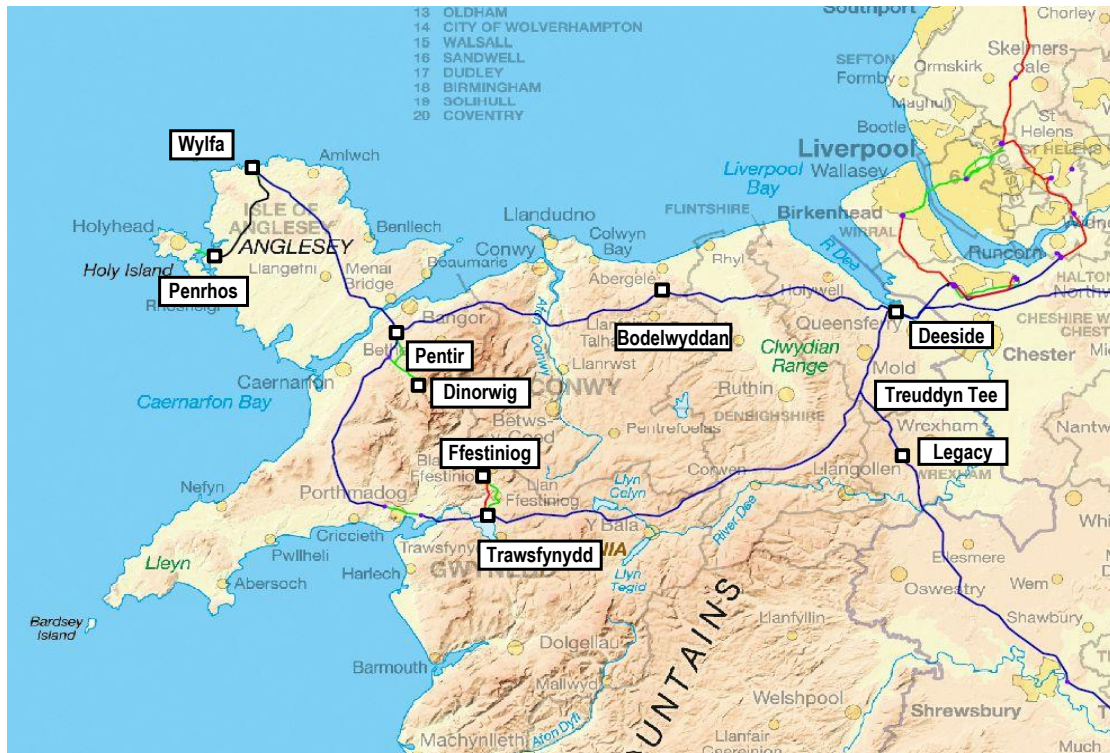

Figure 3.1 – Geographical Illustration of the transmission system within North Wales

3.2 Figure 3.2 illustrates the transmission system in North Wales in the form of a schematic diagram, again showing the transmission substations and circuits. The main generator power stations and their output capacities are also shown.

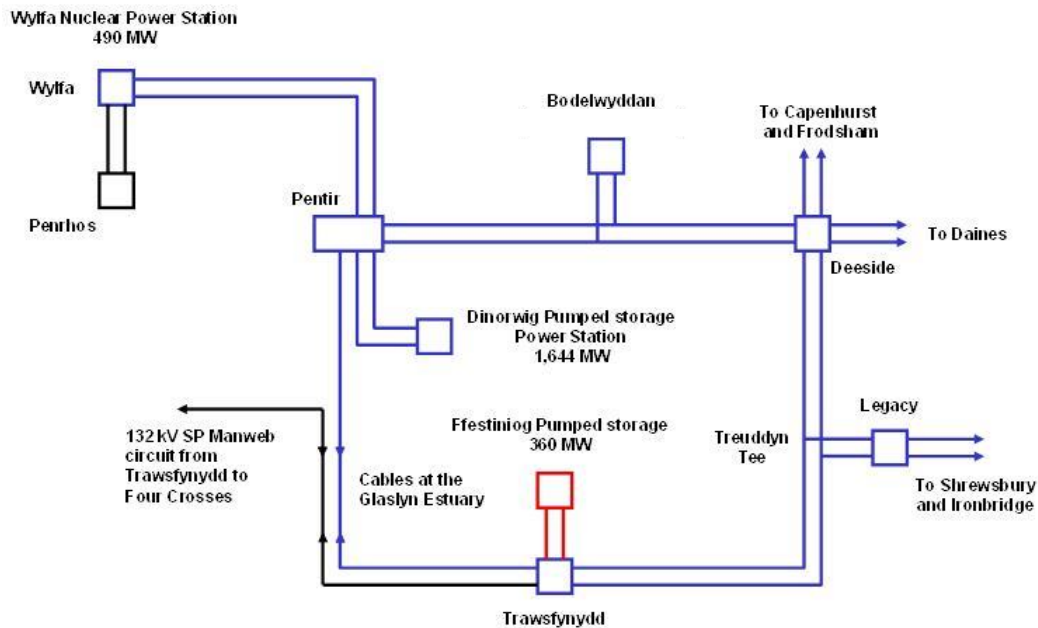

Figure 3.2 – Schematic Diagram of the Transmission System within North Wales

3.3 In summary, the transmission system in North Wales consists of:

- a 400 kV double circuit overhead line between Wylfa and Pentir
- a 400 kV double circuit overhead line between Pentir, Bodelwyddan and Deeside
- two 400kV circuits (partly cable, partly overhead line) between Pentir and Dinorwig
- a 400 kV single circuit between Pentir and Trawsfynydd, with an underground cable section between Wern and Y Garth (Glaslyn Estuary). This circuit occupies one side of a 400 kV tower route. Note that SP Manweb, the local electricity distribution company, has a 132 kV circuit on the other side of the 400 kV tower between Trawsfynydd and Bryncir, where it leaves the route and carries on to Four Crosses substation on wood pole structures, where it supplies electricity to the Llyn Peninsula.
- a 400 kV double circuit overhead line between Trawsfynydd, Legacy and Deeside
- a 275kV double circuit overhead line between Trawsfynydd and Ffestiniog, and
- a 132 kV double circuit overhead line between Wylfa and Penrhos.

- 3.4 As shown in Figure 3.2, SP Manweb, the local Distribution Network Operator (DNO), has a single 132kV circuit mounted on part of the Trawsfynydd to Pentir overhead line route which provides supplies to the Llyn Peninsula.
- 3.5 The double circuit from Pentir to Wylfa connected Wylfa Power Station, a Magnox nuclear station, to the transmission system. This power station has now closed and has commenced decommissioning.
- 3.6 The two circuits between Pentir and Dinorwig substations connect Dinorwig Power Station to the transmission system. Dinorwig Power Station is a pumped storage power station owned by First Hydro Company and is located at Llanberis, Gwynedd.
- 3.7 The two 275kV circuits between Trawsfynydd and Ffestiniog substations connect Ffestiniog Power Station to the transmission system. Ffestiniog Power Station is also a pumped storage power station owned by First Hydro Company and is located at Ffestiniog, Gwynedd.
- 3.8 The transmission system in North Wales is connected to the rest of the transmission system via six 400kV circuits:
- a 400 kV double circuit between Deeside and Daines
 - a 400 kV double circuit between Deeside and the Mersey region, connecting into Capenhurst and Frodsham substations
 - a 400 kV circuit between Legacy, Shrewsbury and Ironbridge substations, and
 - a 400 kV circuit between Legacy and Ironbridge substations.
- 3.9 Power flows on the NETS must not exceed the capability of transmission system equipment at any time. To ensure that this is the case, the NETS SQSS defines the conditions that need to be assessed which include times when all transmission circuits are available as well as times when specific or defined combinations of transmission circuits are not available due to planned or unplanned outages.
- 3.10 The existing transmission system in North Wales has been designed to be compliant with the NETS SQSS and is sufficient to support the forecast customer requirements until 2020. Appendix B provides a summary of the minimum transmission system performance requirements that are defined in the NETS SQSS.

3.11 National Grid assessed the capability of the transmission system in North Wales region. For the purposes of assessing the need for system reinforcement National Grid defines a number of system boundaries, these are not physical boundaries rather they are a method of splitting the network into regional areas to allow the effect of new generation developments to be assessed. The boundaries considered for the North Wales Connections project are boundaries that are reported as part of the ETYS annual publication which describes how the uncertainty of future energy scenarios are managed in both planning and operating the transmission system.

3.12 For this assessment, three boundaries within the North Wales area were identified. Each of these boundaries represents an area of the North Wales network where power is transferred to or from the rest of the NETS. The boundaries considered were:-

- (a) NW1, comprising of the 400 kV double-circuit Wylfa-Pentir;
- (b) NW2, comprising of the 400 kV single-circuit Pentir-Trawsfynydd and the 400 kV double-circuit Pentir - Bodelwyddan- Deeside; and
- (c) NW3, comprising of the 400 kV double-circuit Trawsfynydd-Deeside/Legacy and the 400 kV double-circuit Pentir - Bodelwyddan-Deeside.

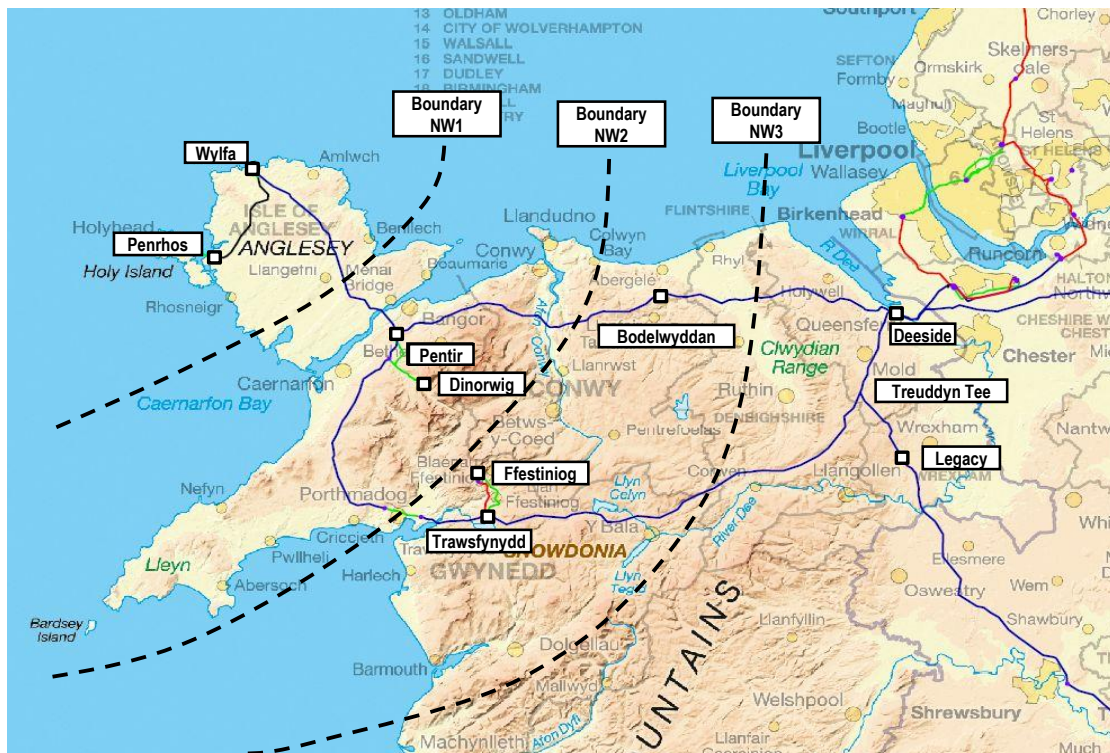

Figure 3.3 – Transmission System Boundaries within North Wales

Capability of the transmission system – Boundary NW1

3.13 Table 3.1 shows the capability of the NW1 Boundary when all transmission circuits are available as well as for the most onerous, unplanned double-circuit outage condition (i.e. the loss of the two circuits with the highest rating) that National Grid is required by the NETS SQSS to assess:

Circuit	Summer Rating MVA
Wylfa-Pentir 1	2,220
Wylfa-Pentir 2	2,220
Total Intact Capability of NW1 Boundary Circuits	4,440
Capability of NW1 Export Boundary less the worst-case double-circuit fault [Wylfa-Pentir]	0

Table 3.1 –Boundary NW1 Circuit Ratings

3.14 The maximum intact export capability of Boundary NW1 is 4,440 MW as shown in table 3.1. However, there is only a single transmission route across this boundary, the Wylfa-Pentir double-circuit. Therefore, a double-circuit fault on that route will result in all generation within Boundary NW1 being disconnected from the transmission system.

Capability of the transmission system – Boundary NW2

3.15 Table 3.2 shows the capability of Boundary NW2 when all transmission circuits are available as well as for the most onerous, unplanned double-circuit outage condition (i.e. the loss of the two circuits with the highest rating) that National Grid is required by the NETS SQSS to assess:

Circuit	Summer Rating MVA
Pentir-Trawsfynydd	2,460
Pentir/Bodelwyddan-Deeside 1	2,220
Pentir/Bodelwyddan-Deeside 2	2,220
Total Intact Capability of NW2 Boundary Circuits	6,900

Circuit	Summer Rating MVA
Capability of NW2 Export Boundary less the worst-case double-circuit fault [Pentir/Bodelwyddan-Deeside1/2 + Pentir-Trawsfynydd]	2,220

Table 3.2 –Boundary NW2 Circuit Ratings

- 3.16 The maximum intact export capability of Boundary NW2 is 6,900 MW as shown in table 3.2. For Boundary NW2, the most onerous double-circuit fault for the export of power is a combination of the Pentir – Trawsfynydd single circuit and one of the Pentir/Bodelwyddan-Deeside circuits.
- 3.17 A fault of this type causes the biggest reduction in transmission capacity, and leaves the region connected to the rest of the transmission system by only one of the Pentir/Bodelwyddan-Deeside circuits. The transmission, or thermal, capacity of Boundary NW2 for this outage condition is limited to 2,220 MW.

Capability of the transmission system – Boundary NW3

3.18 Table 3.3 shows the capability of Boundary NW3 when all transmission circuits are available as well as for the most onerous, unplanned double-circuit outage condition that National Grid is required by the NETS SQSS to assess:

Circuit	Summer Rating MVA
Trawsfynydd-Deeside/Legacy 1	2,750
Trawsfynydd-Deeside/Legacy 2	2,750
Pentir/Bodelwyddan-Deeside 1	2,220
Pentir/Bodelwyddan-Deeside 2	2,220
Total Intact Capability of NW3 Boundary Circuits	9,940
Capability of NW3 Export Boundary less the worst-case double-circuit fault [Trawsfynydd-Deeside/Legacy 1 & 2]	4,440

Table 3.3 –Boundary NW3 Circuit Ratings

3.19 The maximum intact export capability of Boundary NW3 is 9,940 MW as shown in table 3.2. For Boundary NW3, the most onerous double-circuit fault for the export of power is a double-circuit fault on the Trawsfynydd-Deeside/Legacy transmission route.

3.20 A fault on this route, being the highest rated of the transmission lines out of the region, causes the biggest reduction in transmission capacity, and leaves the region connected to the rest of the transmission system by only the lower rated Pentir/Bodelwyddan-Deeside circuits. The transmission, or thermal, capacity of Boundary NW3 for this outage condition is limited to 4,440 MW.

4 Customer Requirements

4.1 This section summarises demand forecasts, export capacity required by existing power station connections and National Grid’s contractual requirements to connect new generators to the NETS in North Wales that are current at the date of this Report.

Electricity Demand in North Wales

4.2 National Grid collects information on an annual basis from customers that import electricity from the transmission system¹⁹. Information is required to be provided to National Grid on a connection point specific basis. Customers are required to provide maximum demand information for the previous year and also demand forecasts for a seven year period. National Grid uses demand forecast information together with information from other sources (e.g. economic growth indicators) to support activities including operation of the transmission system and planning transmission system developments.

4.3 SP Manweb provided demand information for North Wales to National Grid in 2016. A summary of the information provided²⁰ by SP Manweb is included in Tables 4.1 and 4.2.

Transmission Substation	2016/17	2017/18	2018/19	2019/20	2020/21	2021/22	2022/23	2023/24
Penrhos (National Grid) ²¹	1 MW	4 MW	5 MW	0 MW	0 MW	0 MW	0 MW	0 MW
Wylfa	62 MW	87 MW	88 MW	90 MW	91 MW	93 MW	95 MW	97 MW
Pentir ²²	95 MW	109 MW	140 MW	142 MW	145 MW	148 MW	151 MW	154 MW
Trawsfynydd	53 MW	54 MW	54 MW	55 MW	56 MW	57 MW	58 MW	60 MW
TOTAL	211 MW	254 MW	287 MW	287 MW	292 MW	298 MW	304 MW	311 MW

Table 4.1: Forecast peak demand for North Wales

¹⁹ The requirement to provide National Grid with demand information on an annual basis is defined in the Grid Code.

²⁰ SP Manweb is required by the Grid Code to submit information to National Grid on an annual basis.

²¹ National Grid has a directly-connected customer at Penrhos, this data is provided by National Grid.

²² Pentir demands calculated from Pentir/Connahs Quay/St Asaph demand submission

Transmission Substation	2016/17	2017/18	2018/19	2019/20	2020/21	2021/22	2022/23	2023/24
Penrhos (National Grid) ²³	1 MW	1 MW	5 MW	0 MW	0 MW	0 MW	0 MW	0 MW
Wylfa	47 MW	72 MW	73 MW	74 MW	75 MW	77 MW	78 MW	80 MW
Pentir ²⁴	87 MW	101 MW	131 MW	134 MW	136 MW	139 MW	142 MW	145 MW
Trawsfynydd	47 MW	47 MW	48 MW	49 MW	50 MW	50 MW	51 MW	53 MW
TOTAL	182 MW	221 MW	257 MW	257 MW	261 MW	266 MW	271 MW	278 MW

Table 4.2: Forecast Summer demand for North Wales

Generation in North Wales

- 4.4 National Grid has contracts in place with generators that are connected to and/or use the NETS as well as with generators that require a new connection to and/or use of the NETS. The point that the generator connects to the NETS (the “Connection Point”), the level of export capacity onto the NETS required (the “Transmission Entry Capacity”) and the date from which the connection is required (the “Completion Date”) are defined in a specific connection agreement between National Grid and each generator.
- 4.5 National Grid maintains and publishes a register²⁵ of contractual requirements in respect of generators that have contractual rights to use the NETS.
- 4.6 Table 4.3 is a summary of National Grid’s contractual requirements in respect of generator connections to the NETS in North Wales²⁶:

²³ National Grid has a directly-connected customer at Penrhos, this data is provided by National Grid

²⁴ Pentir demands calculated from Pentir/Connahs Quay/St Asaph demand submission

²⁵ Transmission Entry Capacity Register (“TEC Register”):
<http://www2.nationalgrid.com/UK/Services/Electricity%20connections/Industry%20products/tec%20register/>

²⁶ Based on the TEC Register dated 1 August 2014

Generation Name	Generation Type	Connection Point	Completion Date	Transmission Entry Capacity (MW)
Dinorwig	Pumped Storage	Dinorwig	Existing	1,644
Ffestiniog	Pumped Storage	Ffestiniog	Existing	360
Dolgarrog	Hydro	Embedded (Pentir)	Existing	39
Maentwrog	Hydro	Embedded (Trawsfynydd)	Existing	30
Cwm Dyli	Hydro	Embedded (Trawsfynydd)	Existing	10
Gwynt y Môr	Offshore Wind	Bodelwyddan	Existing	565
Burbo Bank Extension	Offshore Wind	Bodelwyddan	2016	254
Greenwire Wind Farm	Offshore Wind	Pentir	2020	1,000
Codling Park Wind Farm	Offshore Wind	Pentir	2021	1,000
Wylfa Newydd	Nuclear	Wylfa	2024 - 2025	2,800
Orthios Power	Biomass	Penhros (Wylfa 132 kV)	2019 - 2020	299

Table 4.3: Existing and future contracted generator connections in North Wales

- 4.7 The term “Embedded” is used within Table 4.3 to describe generation that is connected to the NETS via SP Manweb’s distribution network.
- 4.8 The next section summarises the results from National Grid’s assessment of whether the existing transmission system would be adequate for the additional customer requirements.

5 Need for Transmission System reinforcement in North Wales

Transmission System Capacity Assessments

- 5.1 National Grid assessed whether there was sufficient capacity available in the existing transmission system in North Wales (described in Section 3 of this Report) to accommodate the changes to customer requirements set out in Section 4 of this Report.
- 5.2 The design of new electrical connections between power stations and the transmission system, and any reinforcements or modifications to the existing transmission system, must comply with criteria set out in a number of documents particularly the National Electricity Transmission System Security and Quality of Supply Standard or “NETS SQSS”.²⁷ This is a document which is required by Licence Condition C17 of the National Grid licence and sets out certain criteria which National Grid must comply with in planning, developing and operating the transmission system.
- 5.3 In accordance with the requirements of NETS SQSS, National Grid is required to continually assess the transmission system to ensure a number of electrical parameters stay within prescribed limits, for example, voltage, frequency, current carrying capacity, stability and fault current carrying capacity. There are two performance characteristics which are particularly relevant in the assessment of the transmission system in North Wales and these clearly demonstrate the need to upgrade the transmission system following the connection of new generation and their assessment is described in this section. They are:
- (a) the potential for the disconnection of more than 1,800 MW of generation following two concurrent transmission faults (“loss of power infeed”), and
 - (b) not exceeding the power transfer capacity of the circuits, or “circuit rating” following two concurrent transmission faults.
- 5.4 Other performance characteristics also demonstrate the need to upgrade the transmission system but failure against any of the criteria demonstrates the need and

²⁷ NETS SQSS Version 2.1: http://www.nationalgrid.com/NR/rdonlyres/784F2DFC-133A-41CD-A624-952EF4CCD29B/45776/NETSSQSS_v21_March2011.pdf

the two performance characteristics listed above are the most relevant with regards to the North Wales Connections.

Loss of Power Infeed

- 5.5 Section 2 of the NETS SQSS contains the planning criteria applicable to the connection of power stations to the transmission system. Paragraph 2.6.4 of the NETS SQSS requires that following the concurrent fault outage of any two transmission circuits the loss of power infeed to the system shall not exceed a defined value, currently set at 1,800 MW. It is set at a level which strikes an economic balance between the cost of connecting generation to the transmission system and the cost of having generators in a state of readiness to provide prompt support in the event of fully operational generators being disconnected.

Circuit ratings

- 5.6 Section 2.10 of the NETS SQSS requires that following certain defined events on the transmission system, whether planned, unplanned or a combination of both, in general terms, the ratings of circuits shall not be exceeded.
- 5.7 Paragraph 2.8.5 of the NETS SQSS requires that conditions on the NETS shall be set to those which ought reasonably to be expected to arise in the course of a year of operation. Based on the contracted generation background as set out in Section 4, the generation assumptions are as follows:

Generator	Transmission Entry Capacity (MW)	Included	Year	Contributing Generation (MW)
Dinorwig	1,644	Yes (2 units)	Existing	548
Ffestiniog	360	No	Existing	0
Embedded (Dolgarrog, Maentwrog & Cwm Dyli)	79	No	Existing	0
Gwynt y Môr	565	Yes	Existing	565
Burbo Bank Extension	254	Yes	2016	254
Orthios Power	299	Yes	2019-2020	299
Greenwire Wind Farm	1,000	Yes	2020	1,000
Codling Park Wind Farm	1,000	Yes	2021	1,000
Wylfa Newydd	2,800	Yes	2024-2025	2,800
TOTAL				6,466

Table 5.1: Generation Contributing to Peak Summer Export in North Wales

Results of assessment of availability of transmission capacity – Boundary NW1

5.8 National Grid's assessment in Section 3 shows that the capability of Boundary NW1 is 0 MW following a double-circuit fault, resulting in any generation in NW1 being disconnected from the transmission system. As explained in paragraph 5.9, above, a maximum of 1,800MW of power infeed can be disconnected from the transmission system for such a fault; thus the maximum amount of generation that can be connected in NW1 without reinforcement is 1,800 MW.

5.9 Figure 5.1 below illustrates how the connection of new generation in the NW1 area grows over time per the connection dates in Table 5.1. The predicted growth in cumulative generation is compared to the 1,800 MW capability.

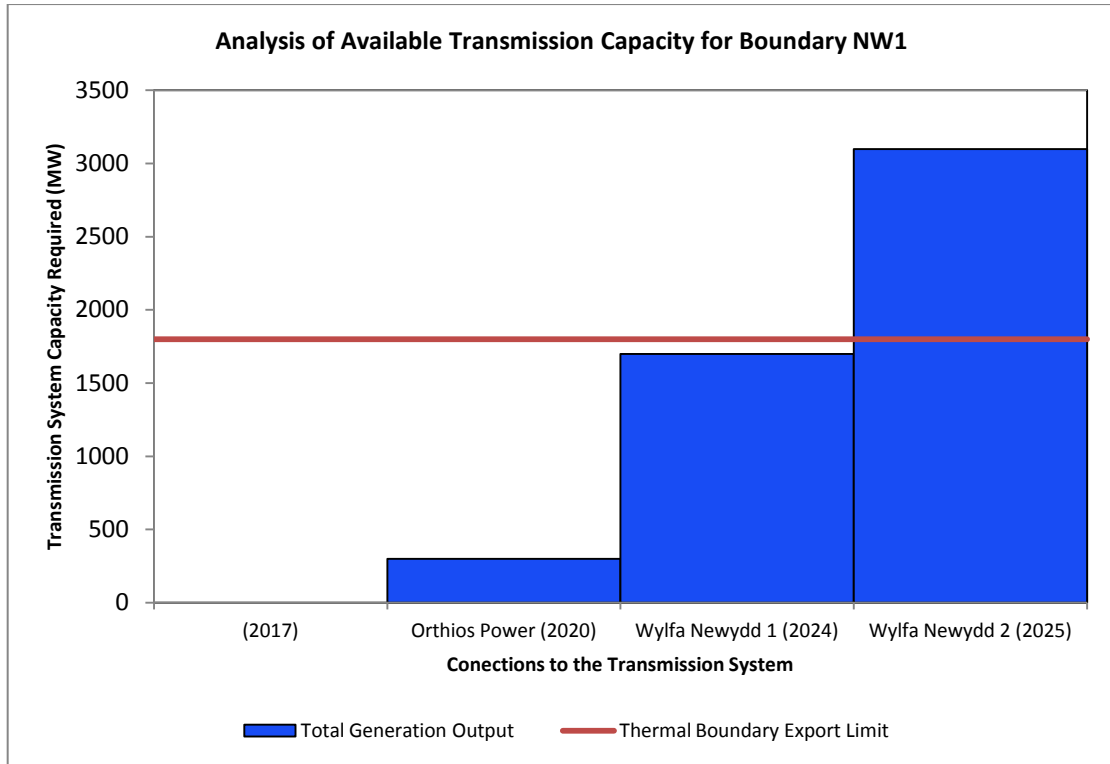

Figure 5.1: NW1 Boundary Exports. Transmission Capacity

5.10 From the assessment, National Grid forecasts that without reinforcement, the transmission system in the NW1 region would not be compliant with the NETS SQSS from 2025.

Results of assessment of availability of transmission capacity – Boundary NW2

5.11 National Grid's assessment in Section 3 shows that the capability of Boundary NW2 is limited to 2,220 MW to ensure that the thermal capacity of the NETS in that region is not breached.

5.12 Figure 5.2 below illustrates how the connection of new generation in the NW2 region grows over time per the connection dates in Table 5.1. The predicted growth in cumulative generation, less the demand in the NW2 region, is compared to the thermal capability limit.

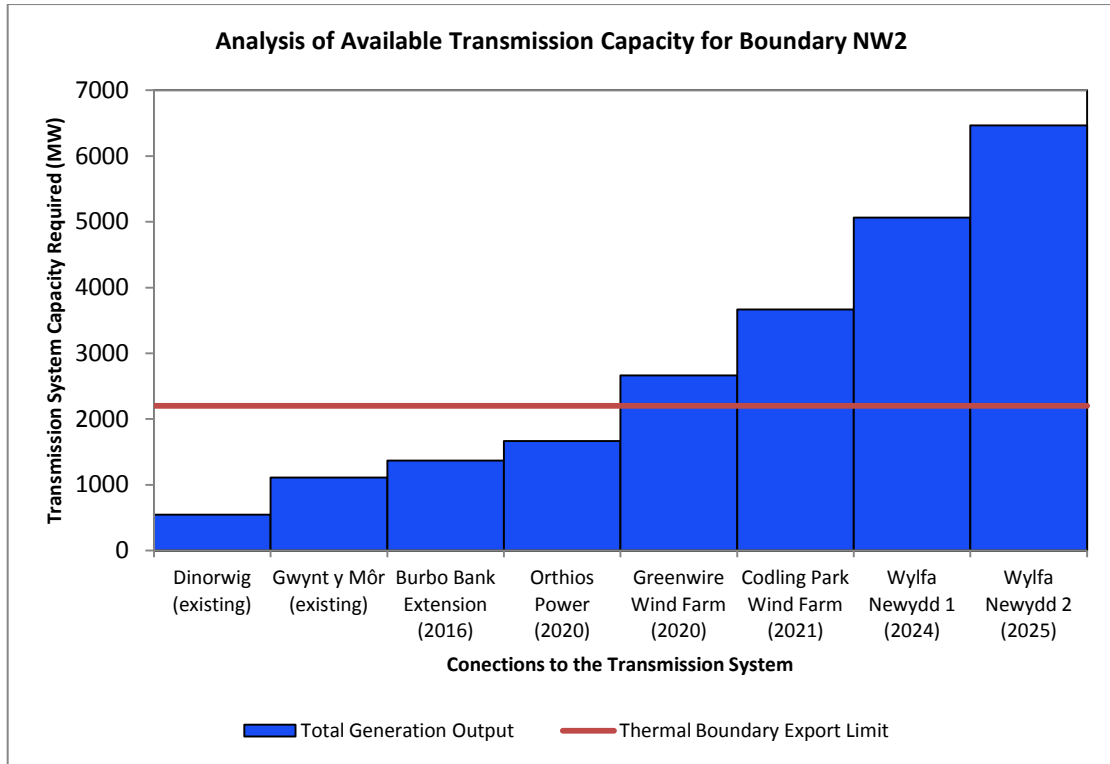

Figure 5.2: NW2 Boundary Export s. Transmission Capacity

5.13 From the assessment, National Grid forecasts that the transmission system in the NW2 region would not be compliant with the NETS SQSS from 2020.

Results of assessment of availability of transmission capacity – Boundary NW3

5.14 National Grid’s assessment in Section 3 shows that the capability of Boundary NW3 is limited to 4,440 MW to ensure that the thermal capacity of the NETS in that region is not breached.

5.15 Figure 5.3 below illustrates how the connection of new generation in the NW3 region grows over time per the connection dates in Table 5.1. The predicted growth in cumulative generation, less the demand in the NW3 region, is compared to the thermal capability limit.

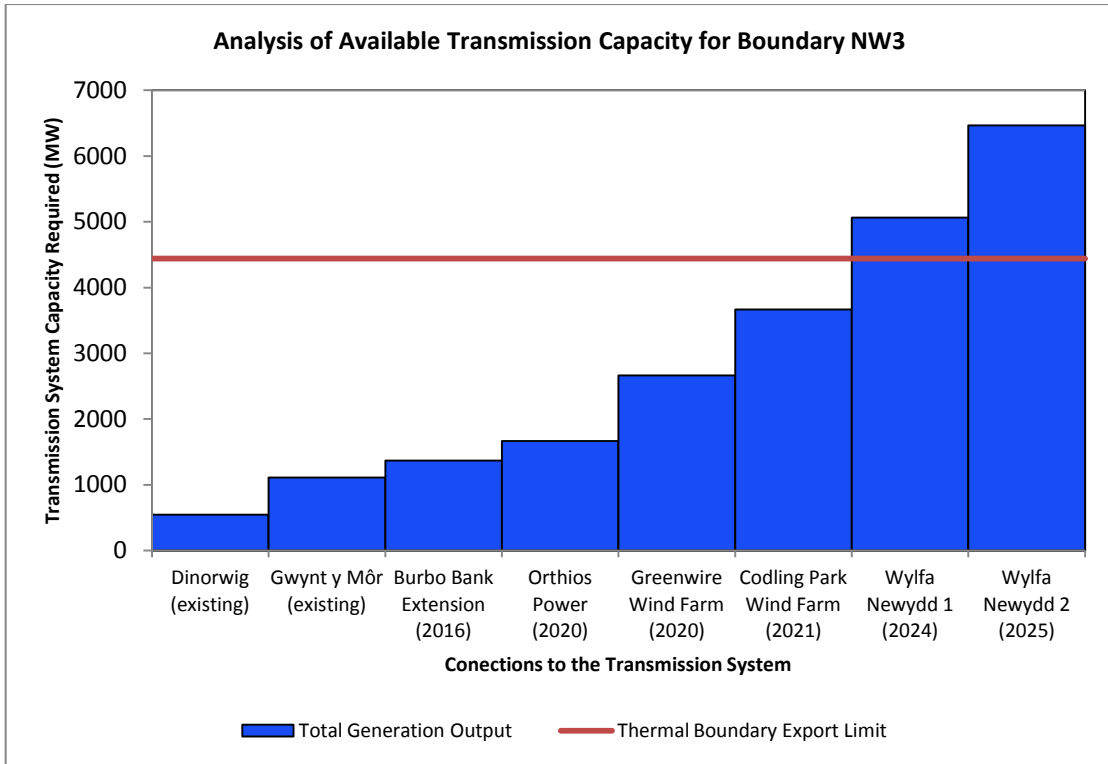

Figure 5.3: NW3 Boundary Export s. Transmission Capacity

5.16 From the assessment, National Grid forecasts that the transmission system in the NW3 region would not be compliant with the NETS SQSS from 2024.

6 Conclusions

6.1 National Grid has signed connection agreements to connect 5,353MW of new generation in North Wales:

- Burbo Bank Extension, 254 MW connecting in 2016
- Orthios power, 299 MW connecting in 2020
- Greenwire Wind Farm (Pentir), 1,000 MW connecting in 2020
- Codling Park Wind Farm, 1,000 MW connecting in 2021
- Wylfa Newydd, 2,800 MW connecting in 2024 - 2025

6.2 This report has considered three transmission boundaries in North Wales, NW1, NW2 and NW3. The existing transmission system in North Wales is sufficient to comply with the NETS SQSS for current levels of generation and demand.

6.3 Against the current contracted generation background, reinforcement across Boundary NW1 would be required by 2025, reinforcement across Boundary NW2 would be required by 2020 and reinforcement across Boundary NW3 would be required by 2024.

6.4 The analysis of options by which the transmission capacity requirements identified in this Report may be met is documented in Issue 2 of the North Wales Connections Strategic Options Report. The Strategic Options Report is available at:

<http://www.northwalesconnection.com>

Appendix A – Summary²⁸ of National Grid Legal Obligations

- A.1 Transmission of electricity in Great Britain requires permission by a licence granted under Section 6(1)(b) of the Electricity Act 1989 ("the Electricity Act").
- A.2 National Grid has been granted a transmission licence and is therefore bound by the legal obligations primarily set out in the Electricity Act and transmission licence.
- A.3 National Grid owns and operates the transmission system in England and Wales and is also responsible for operation of parts of the onshore transmission system that are owned by other transmission licensees (SP Transmission Limited and Scottish Hydro Electricity Transmission Limited).
- A.4 National Grid has a statutory duty to develop and maintain an efficient, coordinated and economical system of electricity transmission under Section 9 of the Electricity Act. These duties, which are documented in standard conditions of the transmission licence (the "Standard Conditions"), are summarised in the following paragraphs.
- A.5 Standard Condition C8²⁹ (Requirement to offer terms) of National Grid's transmission licence sets out obligations on National Grid regarding provision of offers to provide connections to and/or use of the transmission system. In summary, where a party applies for a connection National Grid is to offer to enter into an agreement(s)³⁰ to connect, or to modify an existing connection, to the transmission system and the offer shall make detailed provision regarding the:
- carrying out of works required to connect to the transmission system
 - carrying out of works (if any) in connection with the extension or reinforcement of the transmission system, and
 - date by when any works required permitting access to the transmission system (including any works to reinforce or extend the transmission system) shall be completed.

²⁸ Summary is not intended as an exhaustive list of National Grid's legal obligations but provides information about the obligations that are particularly relevant to this report.

²⁹ The condition also relates to the use of system and some embedded generating plant.

³⁰ Paragraph 6 of Licence Condition C8 sets out exceptions where National Grid is not obliged to make an offer e.g. where to do so would put it in breach of certain other contracts or regulations.

- A.6 Standard Condition C10 (Connection and Use of System Code) requires National Grid to prepare a connection and use of system code ("CUSC") which sets out, among other things, the terms of the arrangements for connection to and use of the transmission system.
- A.7 Standard Condition C14 (Grid Code) requires National Grid to "prepare and at all times have in force and shall implement and comply with the Grid Code". This document (among other things), sets out the technical performance and data provision requirements that need to be met by users connected to or seeking to connect to the transmission system. The document also sets out the process by which demand data from Network Operators and other users of the transmission system should be presented on an annual basis to allow National Grid to plan and operate the transmission system.
- A.8 Standard Condition C17 (Transmission system security standard and quality of service) requires National Grid to at all times plan, develop and operate the transmission system in accordance with the National Electricity Transmission System Security and Quality of Supply Standard (NETS SQSS). This condition includes specific arrangements (Connect and Manage Derogation) that permit National Grid to offer to connect a customer to the transmission system before all reinforcement works to achieve compliance with the NETS SQSS are complete. Such permissions are subject to National Grid publishing Connect and Manage Derogations and reporting to Ofgem.
- A.9 Standard Condition C26 (Requirements of a connect and manage connection) supplements the obligations³¹ applicable to National Grid when making an offer of connection to the transmission system. The connect and manage connection regime was introduced in August 2010. One intention of this regime is to facilitate the timely connection of new generation projects.
- A.10 As well as the technical standards described above, Schedule 9 of the Electricity Act 1989 requires National Grid³², when formulating proposals for new lines and other works, to:
- "...have regard to the desirability of preserving natural beauty, of conserving flora, fauna, and geological or physiological features of special interest and of protecting

³¹ Standard condition C8 of the electricity transmission licence.

³² Schedule 9 of the Electricity Act is applicable to all parties that hold a licence granted under the Electricity Act.

sites, buildings and objects of architectural, historic or archaeological interest; and to do what [it] reasonably can to mitigate any effect which the proposals would have on the natural beauty of the countryside or on any such flora, fauna, features, sites, buildings or objects".

A.11 National Grid's Stakeholder, Community and Amenity Policy ("the Policy") sets out how the company will meet the duty to the environment placed upon it. These commitments include:

- only seeking to build new lines and substations where the existing transmission infrastructure cannot be upgraded technically or economically to meet transmission security standards
- where new infrastructure is required seek to avoid areas nationally or internationally designated for their landscape, wildlife or cultural significance, and
- minimising the effects of new infrastructure on other sites valued for their amenity.

A.12 The Policy also refers to the application of best practice methods to assess the environmental impacts of proposals and identify appropriate mitigation and/or offsetting measures. Effective consultation with stakeholders and the public is also promoted by the Policy.

Appendix B – Transmission System Analysis Principles

- B.1 This appendix provides a more detailed overview of:
- i Transmission system performance requirements (defined in the NETS SQSS);
 - ii Transmission system capability assessment methods, and
 - iii Factors that limit transmission system capability.

NETS SQSS Requirements

- B.2 The NETS SQSS is a document that defines the minimum standards that National Grid must apply when planning and operating the transmission system. These criteria include the type of faults (or breakdowns) and combinations of faults that the transmission system must be able to withstand, the impact on customers in terms of maximum level of supply interruptions, and impacts on supply quality that are permissible.
- B.3 The NETS SQSS is open to industry and public scrutiny, is subject to periodic review and consultation and any changes are implemented by a change to the relevant Standard Condition in the transmission licence made by the industry regulator, Ofgem³³.
- B.4 The NETS SQSS requires that National Grid must plan for all demand and generation conditions (or “backgrounds”) “which ought reasonably to be foreseen to arise in the course of a year of operation ... [and] shall include forecast demand cycles, typical power station operating regimes and typical planned outage patterns.”
- B.5 Application of the NETS SQSS achieves minimum performance requirements for the transmission system. These minimum performance requirements underpin the performance of the transmission system in terms of reliability of service delivered and availability of the system for use by generators, demand customers and other users of the transmission system.

³³ Ofgem Website: <https://www.ofgem.gov.uk/>

- B.6 The NETS SQSS defines the performance required of the NETS in terms of maximum levels of supply interruptions and also in terms of technical limits including that at all times:
- i Electricity system frequency should be maintained within statutory limits;
 - ii No part of the transmission system should be overloaded beyond its capability;
 - iii Voltage performance should be within acceptable statutory limits, and
 - iv The system should remain electrically stable.
- B.7 Any transmission system is susceptible to faults that affect the ability of that transmission system to transfer power. Most faults are temporary and many are related to weather conditions such as lightning or severe wind. Many transmission system circuits can be automatically restored to operation within minutes of a transient fault (e.g. a lightning strike). Other faults may be of longer duration and would require repair or replacement of failed electrical equipment.
- B.8 While some of these faults may be more likely than others, faults may occur at any time and it would not be acceptable to have a significant interruption to electricity supply as a result of credible fault conditions, including certain concurrent combinations of faults. The principle underlying the NETS SQSS is that the NETS should have sufficient resilience that credible fault conditions do not result in widespread electricity supply interruptions. The level of security of supply that has been determined ensures that the risk of supply interruptions as a consequence of faults on the NETS is managed.
- B.9 The total generation capacity connected to the NETS exceeds maximum demand. National Grid is not required to provide transmission system infrastructure that is capable of accommodating the total output from all connected generators as with current market arrangements, this would not be a credible operating scenario.
- B.10 National Grid is required to provide transmission system infrastructure that meets the NETS SQSS criteria for both of the following categories of the following background conditions:
- i Security planned transfer condition, and

- ii Economy planned transfer condition.
- B.11 For the security planned transfer condition, National Grid is required to take account of generation capacity that is considered to be able to reliably contribute to peak demand conditions on the NETS. Appendix C of the NETS SQSS defines the techniques that should be used to scale generation outputs.
- B.12 For the economy planned transfer condition, National Grid is required to take account of the total generation capacity connected to the NETS as well as large power stations that are connected to distribution systems. Appendix E of the NETS SQSS defines the techniques that should be applied to scale each of three main categories of generation plant. The three categories defined in Appendix E of the NETS SQSS are non-contributory generation, directly scaled plant and variably scaled plant.
- B.13 For National Grid's analysis of the transmission system for an economy planned transfer condition, outputs from individual generators within the category of:
- i directly scaled plant are scaled by the technology specific scaling factors defined in Appendix E of the NETS SQSS;
 - ii variable scaled plant are scaled by a calculated factor which is based on the difference between the forecast peak demand and the total scaled output from directly scaled plant, and
 - iii non-contributory generation is set at zero.
- B.14 This scaling of generation output is a method by which National Grid ensures that infrastructure design appropriately reflects the operating arrangements of generation across the whole system (e.g. generators running at a reduced output so as to respond to generator breakdowns; variability in renewable outputs; expensive generators³⁴ running only periodically).
- B.15 Based on normal operation of the electricity market and the fact that generators need to secure customers for electricity produced, National Grid considers that it is reasonable to expect generators to reduce their output or turn off as demand levels

³⁴ "Expensive Generation", can be considered as generators which require a high energy price to make it economic to produce electricity. Such examples could be combined cycle gas turbines (CCGT) generation which has to burn fuel (gas) which has a cost. The highest electricity prices are generally seen at times of high electricity demand.

decrease. Daily peak demands vary across the year between 100-70% of their peak winter value.

Transmission System Capability Assessment

- B.16 Transmission system capability is determined by the rating of plant and equipment, how individual items are connected to form parts of the transmission system and the technical characteristics of customer equipment connected to that part of the transmission system. Capability can be further limited by the need to meet the minimum requirements set out in the NETS SQSS.
- B.17 The NETS SQSS defines the performance required of the NETS in terms of maximum levels of supply interruptions and also in terms of technical limits including that at all times:
- i Electricity system frequency should be maintained within statutory limits;
 - ii No part of the NETS should be overloaded beyond its capability;
 - iii Voltage performance should be within acceptable statutory limits, and
 - iv The system should remain electrically stable.
- B.18 National Grid assesses the adequacy of its transmission system on a regular basis to ensure its continued compliance with the minimum standards of security and quality of supply defined in the NETS SQSS. Assessments are also made by National Grid when there are changes to customer requirements (e.g. a request for a new connection) or when existing transmission system equipment approaches the end of its design life.
- B.19 When assessing the capability of the transmission system, National Grid needs to ensure that the minimum standards of the NETS SQSS can be met. The NETS SQSS defines criteria that must be applied when designing or operating the NETS.
- B.20 National Grid carries out detailed transmission system analysis work using a computer model ("power system analysis"). The computer model replicates the electrical characteristics of the NETS and relevant sections of all customer connections to the NETS. Using this computer based tool, National Grid is able to carry out a range of analysis including:

- i load flow (assess level of power flows in each part of the transmission system);
- ii fault level (assess level of short duration power flows when there is a fault);
- iii transient stability (assess dynamic performance of the transmission system), and
- iv power quality (ensure that limits in the Grid Code are not exceeded).

B.21 National Grid's assessment of transmission system capability, capacity, NETS SQSS compliance and any transmission system reinforcement requirements is informed by results from power system analysis. National Grid assesses the adequacy of its transmission system in accordance with the principles detailed in the NETS SQSS.

B.22 NETS SQSS compliance is always assessed at maximum demand conditions. It is often the case that if the capability of the transmission system is sufficient to meet maximum demand it will be sufficient to meet lower levels of demand. However, National Grid is required to ensure that its transmission system complies with the NETS SQSS requirements at all times of the year for conditions that can be reasonably foreseen. It is possible for the most onerous transmission system operating conditions to occur other than at times of maximum demand. Therefore National Grid also considers lower demand conditions (in particular for parts of the electricity transmission system where there is much more generation than demand).

B.23 National Grid is required to design new generator connections to the NETS to ensure that the maximum export from the new generator connection can be accommodated. The design criteria that National Grid applies when designing generator connections are defined in Section 2 of the NETS SQSS.

B.24 Section 4 of the NETS SQSS sets out the design criteria for the main interconnected transmission system. When assessing compliance of the system and planned developments of the system, National Grid is obliged to consider all operating conditions that can be reasonably foreseen. Any assessment of compliance with the design criteria in Section 4 of the NETS SQSS will take account of diversity between the expected operation of different connected plant.

B.25 National Grid is required to assess power flows between regions of the transmission system ("Planned Transfers"). The Planned Transfer from the region is calculated by taking the Maximum Peak Demand in the region from the Total Scaled Generation. The Planned Transfer is therefore the amount of power which will flow between regions at peak. The Boundary Capability is the maximum permissible Planned

Transfer from one part of the NETS to the neighbouring part of the NETS.

- B.26 Planned Transfer calculations will always consider the power flows for the maximum demand conditions. From a security of supply perspective, National Grid will seek to ensure that transmission system infrastructure is adequate to meet national, demand customer requirements during operating conditions that could reasonably occur.
- B.27 Power flows from source (e.g. power station) to demand and will always tend to flow on the shortest routes that provide the least resistance. On the transmission system, this will be along the higher voltage routes e.g. 400 kV and 275 kV. Assessments of power flows on the transmission system are made by National Grid using a computer model of the transmission system ("power system studies"). The power system studies take account of characteristics that influence power flows (e.g. route length, conductor size and type, number of circuits between substations) as well as customer requirements (including demand, generation, interconnector users).

Factors that Limit Transmission System Capability

- B.28 The NETS must be capable of being operated in a safe and secure manner within thermal, voltage, fault level, stability and phase (voltage) unbalance capability limits and minimum transmission system performance standards.
- B.29 The following sections discuss each of these limiting factors, the possible consequences of exceeding capability limits, and generic options that can be used to enhance capability.

Thermal Capability

- B.30 All metallic electrical conductors expand with increasing temperature and have electrical resistance which causes heat to be generated when electrical current flows through the conductor. Overhead and underground conductors are designed to operate up to a certain temperature. For each conductor type, there will be a maximum current which can flow without exceeding the upper operating temperature. This maximum rating will depend on the ambient air or ground temperature, wind speed and any special cooling equipment utilised or specialist materials used to bury conductors.
- B.31 Exceeding the upper operating temperature in overhead lines will cause conductors to sag and safe clearances between the conductors and the ground will no longer be maintained. Also operation above the upper operating temperature of overhead lines

may cause lasting damage to the conductor system. Exceeding the upper operating temperature of underground cables and Gas Insulated Lines causes damage to the conductor system and risks ultimate failure.

- B.32 The maximum power that can be carried by any electrical circuit is directly proportional to the maximum current and is referred to as the “thermal limit” or “rating”. Transmission circuit ratings are dependent on ambient air (overhead lines) or ground (underground cables) temperatures. The maximum rating of a transmission circuit is achieved when ambient temperatures are low and is often referred to as the “winter rating”. A transmission circuit achieves a lower rating when ambient temperatures are higher and the minimum rating is often referred to as the “summer rating”.
- B.33 A transmission circuit may contain a number of different component parts (e.g. overhead lines, underground cables, transformers and other electrical plant such as busbars). While it is usual practice for National Grid to seek to match ratings of components within a transmission circuit, it is not always possible. Where component ratings do not fully align, National Grid produces a composite rating for the transmission circuit which reflects the rating of the limiting component (i.e. aligns with the lowest rating within the transmission circuit).
- B.34 As the location and types of generation and demand on the transmission system evolve, the power flows on the transmission system also change. As power flows increase, transmission system infrastructure becomes more heavily utilised and the thermal capacity margin (difference between utilisation and thermal limit) reduces. If utilisation of a transmission circuit is greater than its thermal limit, then that circuit is “overloaded”. One of the key criteria in the NETS SQSS is that transmission circuits should not be overloaded for operating conditions (including fault conditions) that are reasonably foreseen.
- B.35 Transmission circuit thermal capacity can be enhanced by:
- i Operating existing transmission circuits at higher temperatures (only where such operation can be achieved safely).
 - ii Upgrading existing transmission circuits (e.g. by installing larger conductors).
 - iii Operating existing transmission circuits at a higher voltage (where existing pylons can be modified to support higher voltage circuits).

iv Increasing the number of transmission circuits (e.g. by constructing a new transmission circuit).

B.36 Transmission circuit upgrade options can be identified for overhead line and underground cable transmission circuits. Transmission system reinforcement options have varying levels of efficiency and complexity depending on the thermal compliance issue identified and therefore potential solution options are identified on a project specific basis.

Voltage Capability

B.37 Generally transmission circuits on National Grid's transmission system are operated at either 400 kV or 275 kV. Transmission circuits have to be designed and constructed so that they can operate safely at the specified, operating voltage.

B.38 The voltage on the transmission system is directly proportional to power and as power flows, there is a difference in voltage at the sending end (e.g. a power station) and the receiving end (e.g. demand). This difference is often referred to as a "voltage drop".

B.39 National Grid is legally required³⁵ to maintain voltage levels on the transmission system within a defined bandwidth of $\pm 10\%$ of the declared operating voltage (for circuits of 132 kV and above).

B.40 As use of the transmission system changes (e.g. changes in use by existing and new customers), the power flows on the transmission system also change. As power flows increase, the voltage drops on the transmission system also increase. If voltage on any point of the transmission system is outside of either of these legal thresholds, then there is a voltage compliance issue. One of the key criteria in the NETS SQSS is that there should not be unacceptable voltage conditions on the transmission system.

B.41 Reactive power is required to maintain voltages across the transmission system. Transmission circuits will tend to absorb reactive power when heavily loaded. This characteristic can mean that at times of high demand, and hence high power flows, additional voltage support is required to ensure transmission system voltages remain

³⁵ Electricity Safety, Quality and Continuity Regulations:
<http://www.legislation.gov.uk/all?title=electricity%20safety%20quality>

above the required minimum levels. However, at times of low demand transmission circuits can generate reactive power and hence cause voltage levels to rise beyond the permitted maximum.

- B.42 Transmission circuit voltage capability can be enhanced by:
- i Making adjustments to output voltage from transmission system transformers by tap change operations where available.
 - ii Temporary changes to existing transmission system configuration by National Grid carrying out other switching actions.
 - iii Requiring generators to provide reactive power support from power stations that are operating to also export active power onto the transmission system.
 - iv Entering into commercial contracts with generators for additional reactive support from power stations.
 - v Installing fixed devices (e.g. manually switched capacitors, shunt reactors) on the transmission system that can generate or absorb reactive power.
 - vi Installing dynamic devices (e.g. static voltage compensators) on the transmission system that can produce or absorb reactive power.
 - vii Upgrading existing transmission circuits (e.g. by installing larger conductors).
- B.43 Transmission circuit upgrade options can be identified for overhead line and underground cable transmission circuits. Transmission system reinforcement options have varying levels of efficiency and complexity depending on the unacceptable voltage condition identified and therefore potential solution options are identified on a project specific basis.

Fault Level Capability

- B.44 Strengthening the transmission system to increase thermal and/or voltage capability can also increase the fault levels across the transmission system. "Fault level" is a measure of power that would be expected to flow if there was a fault on the transmission system.

- B.45 Items of electrical plant have a fault rating which defines the maximum power flow that the plant item can withstand for the short duration until the fault is disconnected from the transmission system. For safe operation of the transmission system, the fault level at any particular point on that system must be within the rating of relevant electrical plant items.
- B.46 Fault level capability issues can be managed by National Grid:
- i revising the substation configurations where possible,
 - ii upgrading/reinforcing or replacing any affected infrastructure with modern equivalent assets which have higher ratings,
 - iii incorporating new devices to limit the fault levels
- B.47 Works to manage fault level issues will tend to be confined to within the substation boundary and are therefore not discussed further in this report.

Transient stability

- B.48 The alternating voltage at every point on the transmission system is designed to be in synchronism (or “synchronised”) with the alternating voltage at every other point on that system. In effect, during normal operation the entire transmission system, together with all the connected local distribution systems, generators and synchronous motors are “on the same electrical cycle”. The majority of generation, connected to the Transmission System is made up of large “synchronous machines”. These machines maintain a speed which outputs electrical power at the mains frequency of 50 hertz (50 positive and negative cycles per second) and remain in synchronism with this frequency.
- B.49 The NETS SQSS requires that at all times the system remains “electrically stable”. There are many types of electrical stability issues that could arise, but of particular importance when designing the transmission system for the connection of new generation is “generator transient stability”, which is about maintaining the synchronism of generation following a large disturbance to the power system (e.g. the fault of a transmission circuit).
- B.50 Generator transient stability issues can occur when a fault disrupts the electrical power flows on the transmission system in the vicinity of any generator. The power flow disruption causes the generator to accelerate. The generator accelerates

because during the fault, the electrical power output from the generator reduces to a level that is effectively very small, whilst the mechanical power being put into the generator by the fuel source (steam, wind etc.) remains the same. The greater a generator's power output at the time of the fault the more it will accelerate during the fault. Generators close to the fault on the transmission system will be affected more than generators that are further away.

- B.51 If a generator accelerates to such an extent that its inertia becomes too strong (i.e. its mass is moving too fast), a situation called "pole slipping" can arise. A consequence of pole slipping is that the generator loses synchronism with the transmission system and the forces involved can cause both electrical damage and mechanical damage to that generator.
- B.52 The transmission system is designed so that the faulty sections are automatically disconnected. This type of automatic action is referred to as the electrical fault being cleared. In order to minimise the risk of damage to the transmission system and its connected customers, electrical faults would normally be cleared within tenths of a second.
- B.53 During the time needed to clear the transmission system fault, the generator may have accelerated to such an extent that pole slipping occurs and the generator is no longer synchronised with the rest of the transmission system. Such a loss of synchronism can result in damage to the generators as well as potential interruptions to power supplies. Protection equipment that would disconnect the generator if pole slipping occurs, in accordance with the Grid Code, may also be required by National Grid.
- B.54 Once the electrical fault on the transmission system is cleared, the number and electrical characteristics of the remaining circuits on the transmission system will determine how quickly the extra energy from accelerated generators that remain connected to the transmission system, can be absorbed by that transmission system. In general, the stronger the transmission system capacity, the quicker the extra energy can be absorbed.
- B.55 Generator transient stability issues can be resolved by increasing the capacity of circuits on the transmission system. However, repeatedly increasing the capacity of transmission circuits is not generally an appropriate solution option as it may not provide an efficient nor economic solution. Also, the physical load carrying capability of existing infrastructure would not be sufficient for very large conductors and would require major rebuilding of the entire system in an area to manage the increased

capacity with larger, heavier pylons.

- B.56 The capacity of the transmission system can be increased by providing additional circuit(s). This can be an efficient solution option in areas where thermal capacity issues have also been identified. Additional transmission circuit(s) can resolve generator transient stability issues as well as other thermal capacity issues.
- B.57 The precise behaviour of generators prior to, during and following a fault is unique to their individual locations on the transmission system, the control systems used to manage each generator and its physical design. Generator specific parameters therefore need to be considered in particular detail when planning any new connection to the transmission system.
- B.58 Transmission system stability is recognised as a specialist area and therefore comparison with a hydraulic analogy is also offered in the following two paragraphs. This is provided for information only and is intended to aid understanding of the discussion of electrical system stability issues.
- B.59 Power flows on the electricity transmission system can be considered as flows of high pressure water on a network of narrow hydraulic pipes. Generators are represented by the pumps that pressurise water flows on the hydraulic network. Under normal conditions on the hydraulic network, a stable pattern of water flows will be established. Electrical faults are represented by a pipe rupture on the hydraulic network. The stable pattern of water flows will be disturbed by the ruptured pipe. Pumps in the vicinity of the rupture will be pumping against much reduced resistance and will speed up, with pumps closest to the rupture being more affected than those further away. Fault clearance is represented by the removal of the ruptured pipe section from the hydraulic network. Water flows through the remaining parts of the hydraulic network and a new stable pattern is established.
- B.60 The hydraulic network could be strengthened by increasing the size of all pipes or by adding a new pipe. Strengthening the system by using pipes with thicker walls means that the impact of a ruptured pipe would remain similar: in a 2 pipe system 50% of capacity would be lost if one pipe ruptured. However, by adding an additional pipe to the 2 pipe system, the network becomes a 3 pipe system and the impact of one ruptured pipe would be to reduce capacity by only 33%.

Phase (voltage) unbalance

- B.61 Unbalance of both currents and voltages on the transmission system can be caused

by loads that are not equally balanced across the three phase supply and also by impedance unbalance within the transmission system. Overhead lines can be a major source of transmission system unbalance.

- B.62 Alternating current in a conductor will induce alternating currents in another conductor in close proximity. This phenomenon underpins the operation of generators, electric motors and transformers.
- B.63 Pylons have a circuit on each side (as described in section 4) and power of significant magnitude can flow in opposite directions on these circuits. The current in one conductor of a transmission line will induce currents in the other conductors. This effect occurs between transmission line conductors that make up:
- i A different phase on the same transmission circuit (e.g. on the same side of a pylon), and
 - ii Two different transmission circuits on either side of a pylon.
- B.64 The strength of this induced current effect is dependent on the physical position of the conductor and the magnitude of power flow in each conductor. Each conductor (pylon positions of top, middle and low) induces different currents in each of the other conductors. If uncorrected these different induction effects can lead to imbalances between the currents in the different phases of each circuit.
- B.65 Negative phase sequence currents flow as a consequence of unbalance between phases and these can, in turn, give rise to imbalanced stresses in generators and industrial motors with excessive heat being generated within them. An assessment of phase (voltage) unbalance can be made from the negative phase sequence currents, which can be measured on the transmission system using specialist recording equipment.
- B.66 National Grid is required as a condition of its licence to have in force the Grid Code, which, amongst many other technical requirements, stipulates maximum limits for phase (voltage) unbalance on the transmission system. Unbalance between phases in an electricity system if not adequately limited, can adversely impact on power quality and lead to system disturbance and/or damage to electrical plant and equipment. The Grid Code defines a limit of 1% for phase (voltage) unbalance for normal operating conditions and 2% for abnormal operating conditions (e.g. during fault conditions). Parties connected to the transmission system are required to ensure that their equipment is capable of withstanding phase (voltage) unbalance

conditions up to the maximum limits defined by the Grid Code.

- B.67 National Grid seeks to keep phase (voltage) unbalance at all connection points on the transmission system within the specified limits by switching the position (or “transposing”) the phases of transmission lines where possible. Typically overhead lines are arranged such that the overall effect is mitigated across the network. However, this arrangement which works effectively when the currents in both circuits is flowing in the same direction will not be effective when the currents in the two circuits are flowing in opposite directions, and especially when the magnitudes of these opposing currents are large. Moreover, the compensation will be less effective when there is current flowing in one circuit but not in the other due, say, to the second circuit being on outage.
- B.68 Negative phase sequence currents can be limited by ensuring situations which cause power to flow in opposing directions on the transmission system are reduced and where possible removed. This can be done by removing complex system configurations such as teed circuits, or circuits on the same pylon connecting to different locations. Removing complex configurations is normally achieved by construction of new substations, new transmission circuits or reconfiguration of existing transmission system circuits.

Glossary of Terms and Abbreviations

Availability Scaling Factor	The amount of generation connected to the transmission system is required to be more than National Demand. As a minimum this value has traditionally been 120% of peak demand, this is known as the “Plant Margin”. This allows the operation of generation below its maximum output to cover for breakdowns of generators, intermittency of energy source (wind) and to cover faults of generation while in service. The levels of Scaling Factor is dependant upon the type of generation as explained in this document 85% for nuclear power stations; 70% for wind farms, reflecting the intermittency of wind power; and 83% for other generators.
Boundary Capability	The capability of the transmission system to physically carry the amount of power required between areas. The capability limit will be the lower of the thermal or stability limits relevant to that part of the transmission system.
CCGT	Combined cycle gas turbine, a generator comprising a gas turbine together with a steam boiler and steam turbine utilising the waste heat from the gas turbine thereby achieving high efficiency
EU	European Union
Fault	Electrical fault on a circuit or piece of transmission equipment for which the circuit/equipment switches out automatically
Grid Code	<p>A document produced by National Grid Electricity Transmission (NGET) that details the operating procedures and principles governing NGET's relationship with all users of the national electricity transmission system. The Grid Code specifies day-to-day procedures for both planning and operational purposes and covers both normal and exceptional circumstances.</p> <p>The Grid Code is designed to permit the development, maintenance and operation of an efficient, co-ordinated and economical national electricity transmission system, to facilitate competition in the generation and supply of electricity and is conceived as a statement of what is optimal (particularly from a technical point of view) for all users and NGET itself in relation to the planning, operation and use of the national electricity</p>

transmission system.

km	Kilometre
kV	Kilovolt (1000 Volts)
kW	The quantity of power being instantaneously consumed at any point of time. Therefore a 2kW kettle will instantly draw 2kW of power for every second it is switched on.
kWh	The quantity of energy delivered by a 1 kilowatt flow of power for 1 hour. Therefore the kettle of power rating 2kW, left used for a period of 1hour continuously would use 2kWh of energy. kWh is also the “unit” used for the purposes of billing for electricity supplied to domestic customers.
MVA	Mega Volt Ampere – This is a Standard Unit Of Power and is used to describe physical capabilities of electrical equipment.
MW	Megawatt, equal to 1 million Watts
ms	Millisecond (or one thousandth of a second)
NETS	National Electricity Transmission System
NETS SQSS	National Electricity Transmission System Security and Quality of Supply Standard
Ofgem	The Office of Gas and Electricity Markets
Planned Outage	Planned switching out of a circuit or piece of transmission equipment for maintenance or access.
Planned Transfer	The amount of power expected to be transferred between two areas of the transmission system during normal operation.
Upgrading	Changing the capacity of existing overhead line by replacing the existing conductors with larger capacity conductors.
Synchronism	When the transmission system is operating at the same frequency (speed) of 50Hz the system is synchronised. When one part of the system splits

away or starts to operate at a different frequency this is a loss of Synchronism.

1 GW	1000 MW
1 GWh	1000 MWh
1 kW	1000 W
1 MW	1000 kW
1 MWh	1000 kWh
1 TWh	1000 MWh