

Norfolk Projects Offshore Wind Farms Kittiwake Implementation and Monitoring Plan Annex 5 Kittiwake Structure Final Detailed Drawings



Developer: Norfolk Boreas Limited and
Norfolk Vanguard Limited
Document Reference: PB5640.008.0059

Date: November 2022
Revision: Version 1
Author: Royal HaskoningDHV

Photo: Kentish Flats Offshore Wind Farm

Date	Issue No.	Remarks / Reason for Issue	Author	Checked	Approved
25/08/2022	1.0	Draft for KSG review	DT		
21/09/2022	1.1	Final for approval by KSG	DT	KSG	JL
02/11/2022	1F	Final for approval by the SoS	DT	VR	JL



Table of Contents

1	Introduction	1
2	Wall Structure	1
3	Tower Structure.....	7

Glossary of Acronyms

KSG	Kittiwake Steering Group
KIMP	Kittiwake Implementation and Monitoring Plan
SoS	Secretary of State

1 Introduction

1. This Annex of the Norfolk Projects KIMP provides detailed drawings of the final agreed designs for the Kittiwake artificial nesting structures. An explanation of the evolution in design is provided in section 5 of the KIMP document.
2. Section 2 provides the detailed drawings for the wall structure and section 3 the Tower structure

2 Wall Structure

3. Provided in this section are detailed drawings for the final agreed design for the kittiwake wall nesting structure.

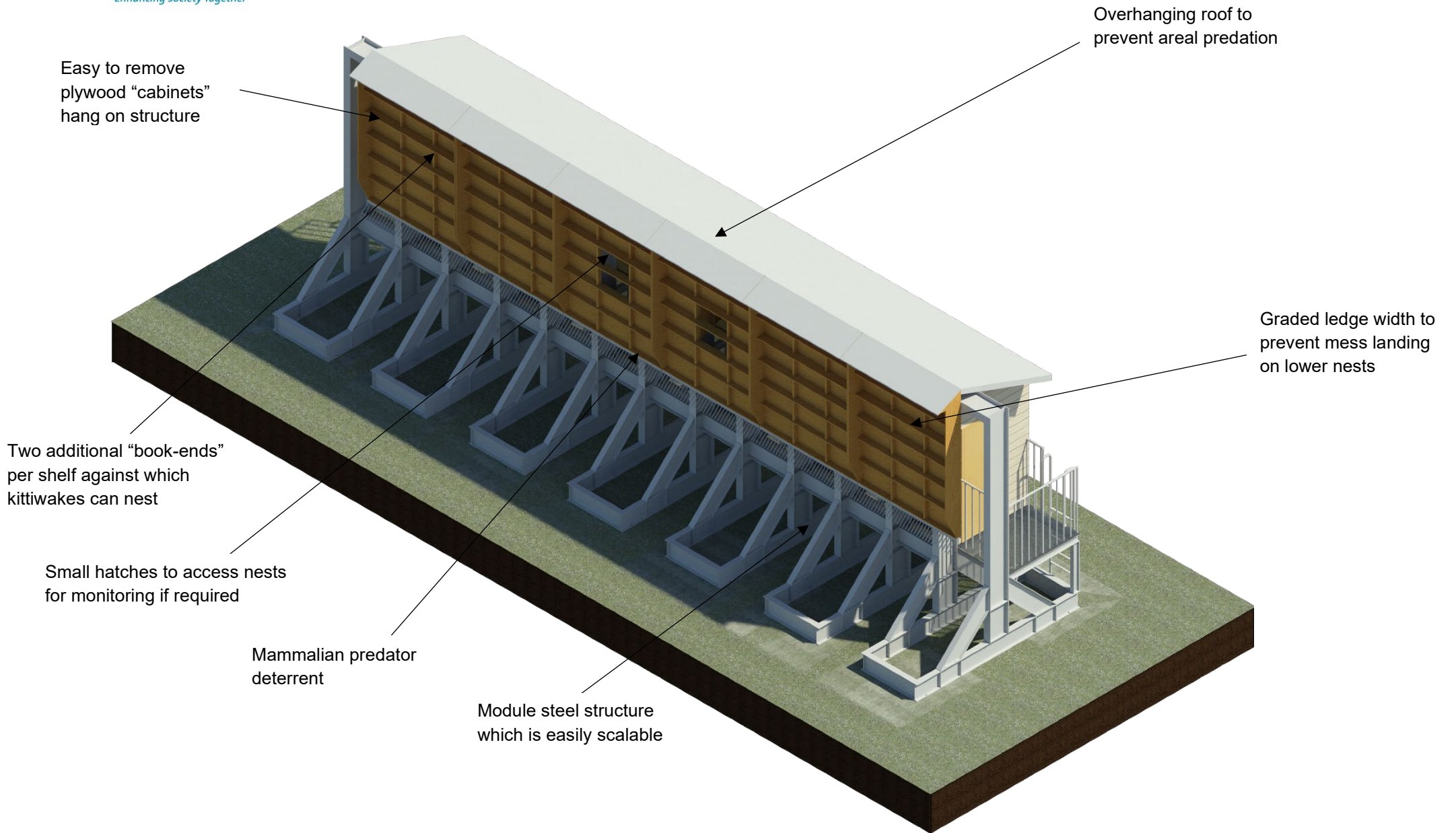

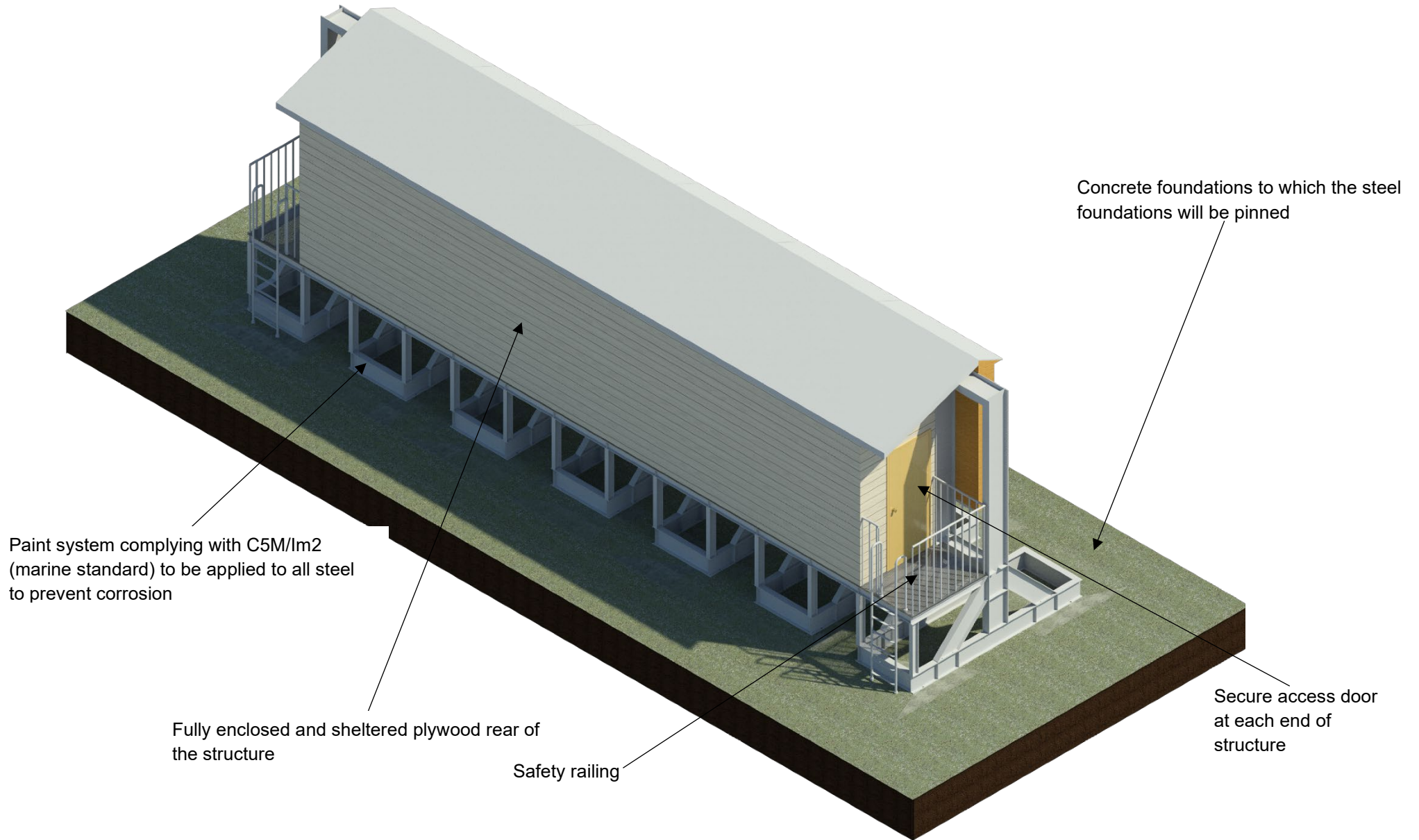

PC2765-RHD-KW-ZZ-DR-C-0008

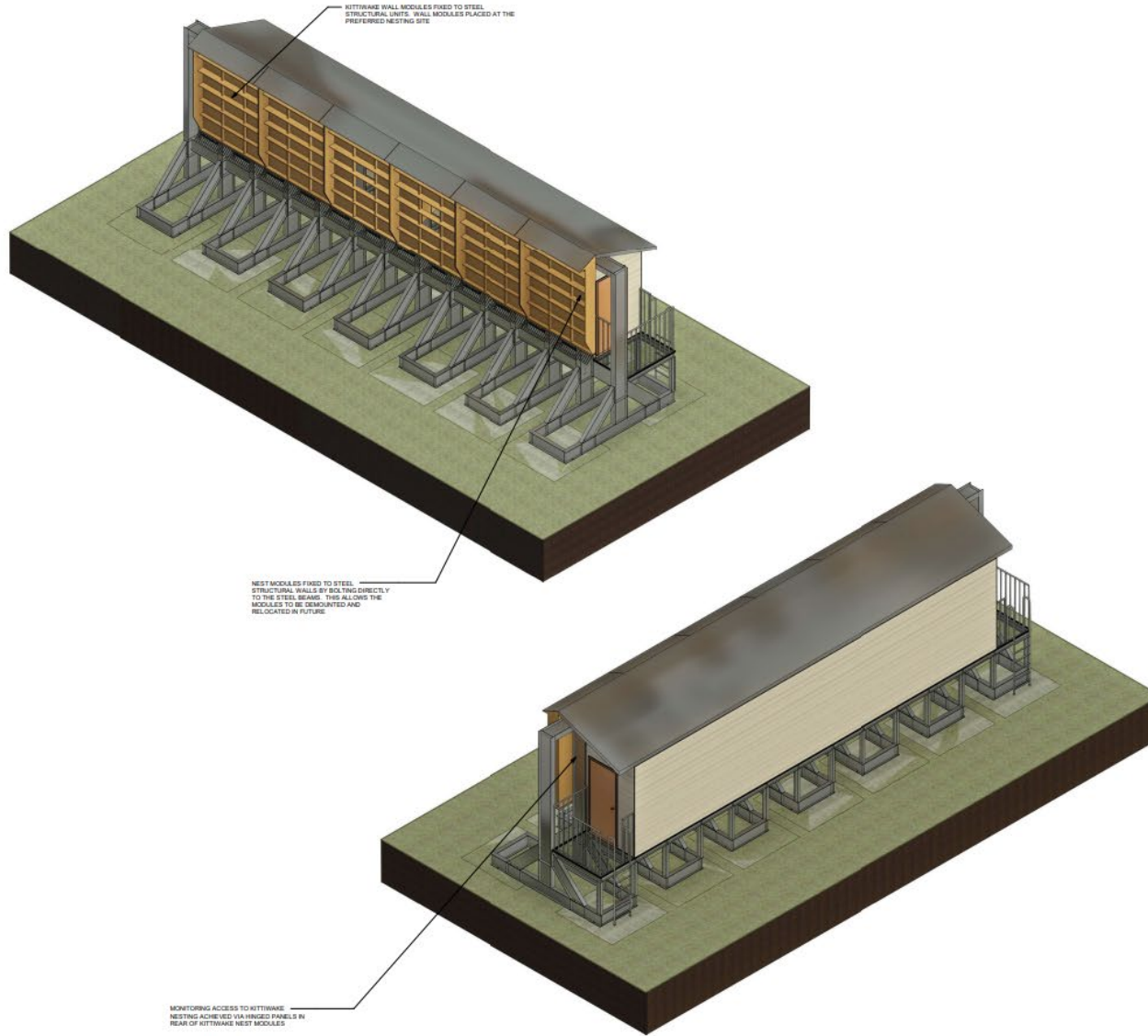

NOTES

1. ALL DIMENSIONS IN MILLIMETRES UNLESS NOTED OTHERWISE
2. CABINET TO BE MANUFACTURED FROM 18mm PLYWOOD TO COMPLY WITH EN 536 CLASS 3 FOR EXTERIOR CONDITIONS (EXPOSURE TO WEATHER OVER SUBSTANTIAL PERIODS OR CONTINUOUS EXPOSURE TO MOISTURE)
3. CABINET TO BE ASSEMBLED TOGETHER USING EXTERIOR GRADE WOOD SCREWS
4. NESTING CABINETS WILL BE SECURED TO UB FLANGES WITH M16 THREADED BOLTS AND WAGERS. EACH CABINET WILL BE SECURED AT MINIMUM 20 LOCATIONS. 120° HORIZONTAL UB FLANGES AND 8° TO VERTICAL UB FLANGES.
5. C20 GRADE 50mm THICKNESS SCREED CONCRETE WILL BE PLACED UNDER THE MASS CONCRETE FOUNDATIONS.
6. HANDRAIL WILL BE R10 GALVANIZED MILD STEEL (GRADE S275) 20mm THICKNESS
7. ACCESS PLATFORM AND STEPS WILL BE STEEL GRATE FLOORING WITH 30mm THICKNESS.

REV	DATE	DESCRIPTION	BY	CHK
1	14/06/22	REPLACED STAIRS WITH LADDER	AT	MY
2	15/06/22	FIRST ISSUE	AT	MY
3	20/06/22	REVISE DATE	BY	DATE

REVISIONS

CLIENT



PROJECT

KITTIWAKE ARTIFICIAL NESTING SITES

TITLE

KITTIWAKE STEEL WALL MODULES



DRAWN	AT	CHECKED	MY	APPROVED	DT
DATE	15/06/22	SCALE	1:1	REV	
DRAWING NO.	PC2765-RHD-KW-ZZ-DR-C-0008	SUBMITALTY	S3	REVISION	P02

PC2765-RHD-KW-ZZ-DR-C-0009

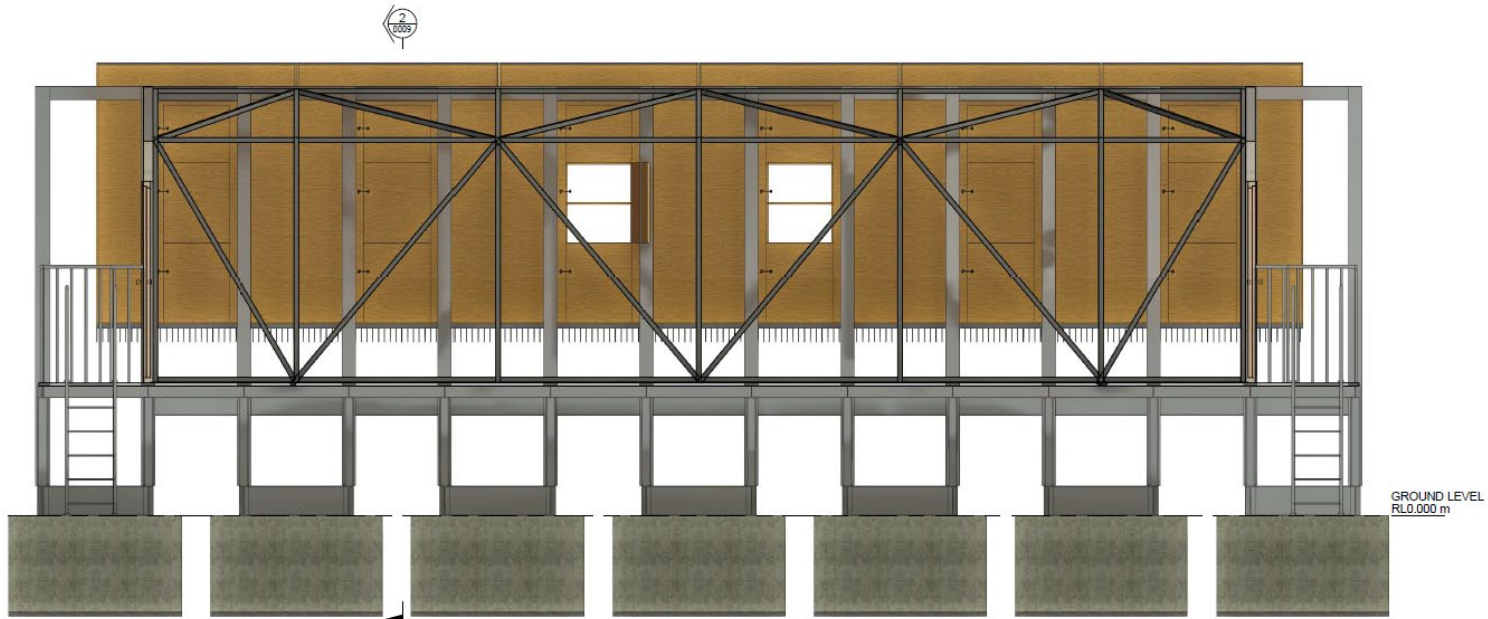

GROUND LEVEL
RL0.000 m

50x50mm RHS GUICURED
BY 100x100 PLATES

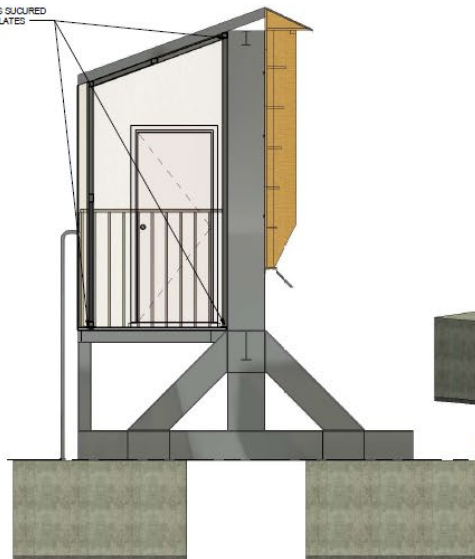

GROUND LEVEL
RL0.000 m

NOTES

1. ALL DIMENSIONS IN MILLIMETRES UNLESS NOTED OTHERWISE
2. CABINET TO BE MANUFACTURED FROM 18mm PLYWOOD TO COMPLY WITH EN1996 CLASS 3 FOR EXTERIOR CONDITIONS (EXPOSURE TO WEATHER OVER SUBSTANTIAL PERIODS OR CONTINUOUS EXPOSURE TO MOISTURE).
3. CABINET TO BE ASSEMBLED TOGETHER USING EXTERIOR GRADE WOOD SCREWS
4. NESTING CABINETS WILL BE SECURED TO UB FLANGES WITH M10 THREADED BOLTS AND WASHERS. EACH CABINET WILL BE SECURED AT MINIMUM 20 LOCATIONS (10 TO HORIZONTAL UB FLANGES AND 8 TO VERTICAL UB FLANGES)
5. (20) GRADE 50mm THICKNESS SCORED CONCRETE WILL BE PLACED UNDER THE MASS CONCRETE FOUNDATIONS
6. HANDRAIL WILL BE RHS GALVANIZED MILD STEEL (GRADE S275) 25mm THICKNESS.
7. ACCESS PLATFORM AND STEPS WILL BE STEEL GRATE FLOORING WITH 30mm THICKNESS.
8. BACK ENCLOSURE HAVING A STRUCTURAL FRAME OF RHS GALVANIZED MILD STEEL (GRADE S275) 60x60mm 25mm THICKNESS.

NO	DATE	BY	CHK	APP
1	15/08/22	AT	MY	DT
2				
3				

REVISIONS:

CLIENT



PROJECT
KITTIVAKE ARTIFICIAL
NESTING SITES

TITLE
STRUCTURAL
FRAME



DATE	BY	CHK	APP
15/08/22	AT	MY	DT

SCALE: 1 : 25

DRAWING NO.	REVISION	SUPPLIABILITY	REVISION
PC2765-RHD-KW-ZZ-DR-C-0009	S3		P02

3 Tower Structure

4. Provided in this section are detailed drawings for the final agreed design for the kittiwake tower nesting structure. It should be noted that the tower option has been ruled out at Lowestoft which is the current proposed location for delivery of the compensation.

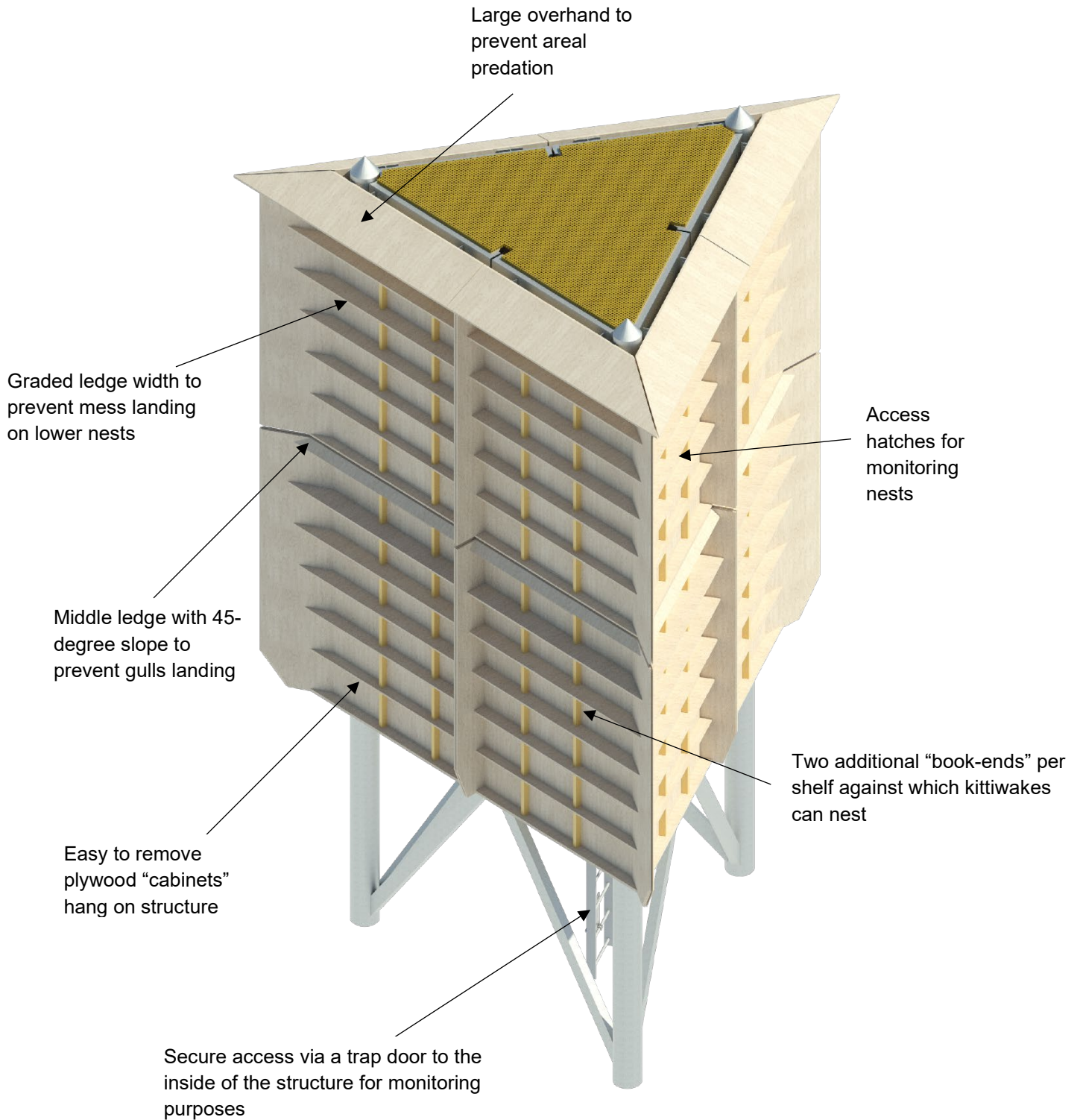

PC2765-RHD-KT-ZZ-DR-C-0001

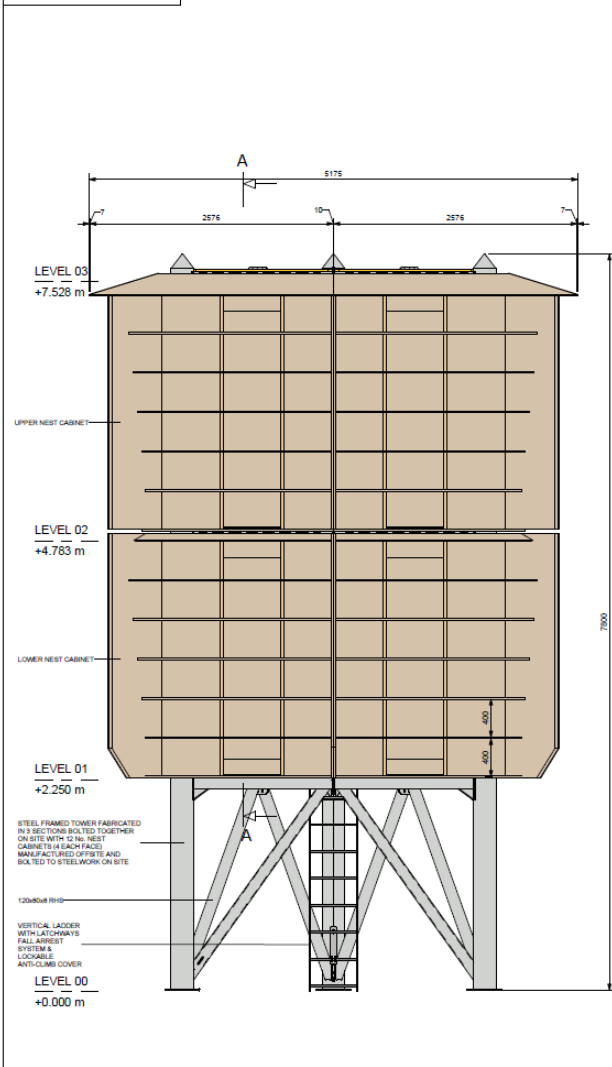

ELEVATION ON GRID LINE 1
Scale: 1: 25

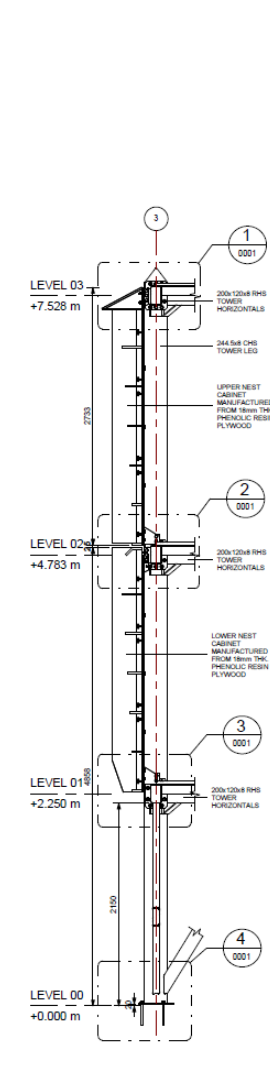

SECTION A-A
Scale: 1: 25

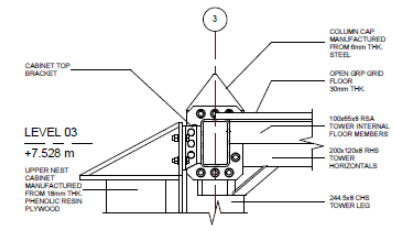

DETAIL 1
Scale: 1: 10

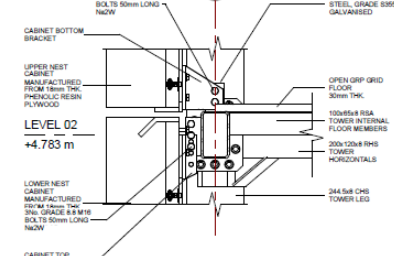

DETAIL 2
Scale: 1: 10

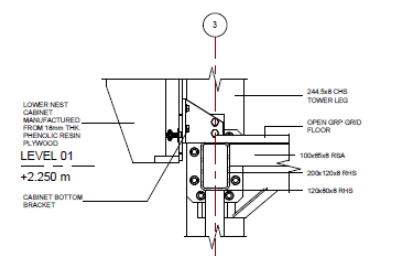

DETAIL 3
Scale: 1: 10

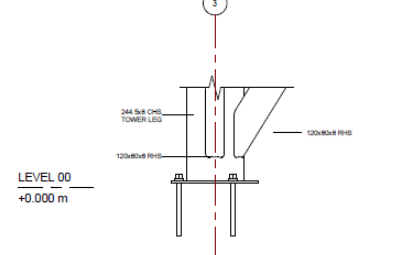

DETAIL 4
Scale: 1: 10

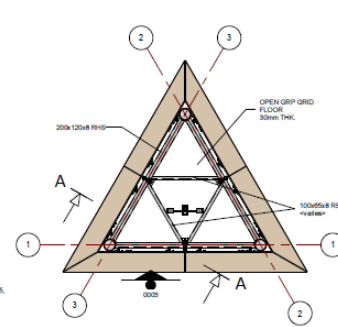

LEVEL 03 - PLAN
Scale: 1: 50

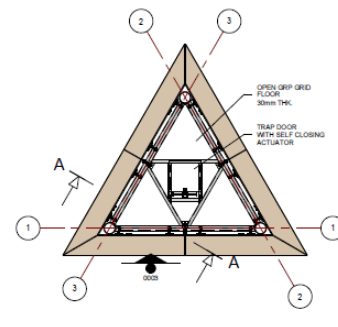

LEVEL 02 - PLAN
Scale: 1: 50

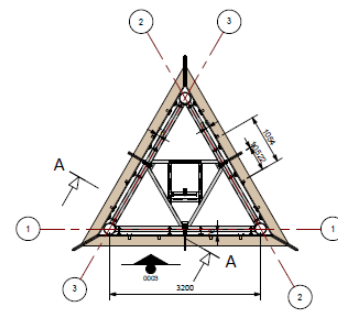

LEVEL 01 - PLAN
Scale: 1: 50

NOTES
1. ALL DIMENSIONS IN MILLIMETRES UNLESS NOTED OTHERWISE.

FIG	230620	CABINET SHELVING UPDATED	AT	MY	DT
FIG. DT	15-08-20	SUITABLE FOR STAGE APPROVAL	AS		
REV	DATE	DESCRIPTION	BY	CHK	APP

CLIENT



PROJECT
VATTENFALL KITTIWAKE STRUCTURES

TITLE
KITTIWAKE NESTING TOWER - GENERAL ARRANGEMENT

Royal HaskoningDHV Enhancing Society Together		13/05/22		AS INDICATED		S4		P02	
DATE	13/05/22	SCALE	AS INDICATED	SUPPORTABILITY	REVISION				
DRAWN	AG	CHECKED		REV					

PC2765-RHD-KT-ZZ-DR-C-0003

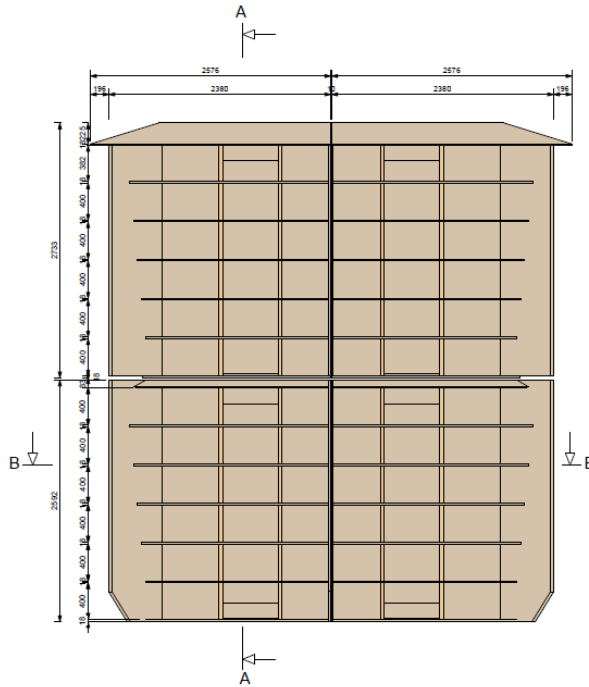

ELEVATION ON NESTING CABINETS
Scale: 1:25

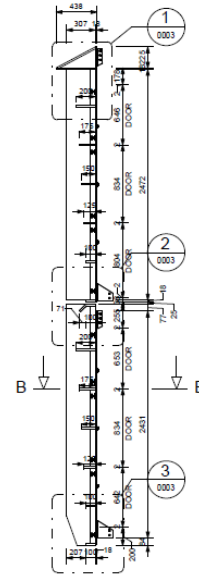

SECTION A-A
Scale: 1:25

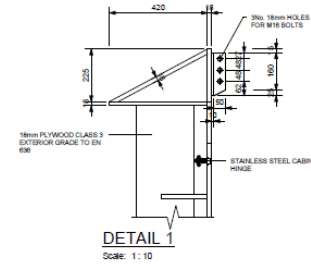

DETAIL 1
Scale: 1:10

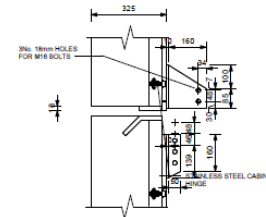

DETAIL 2
Scale: 1:10

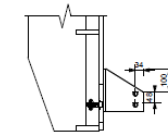

DETAIL 3
Scale: 1:10

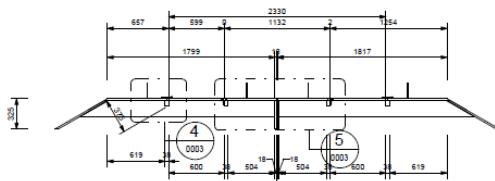

SECTION B-B
Scale: 1:25

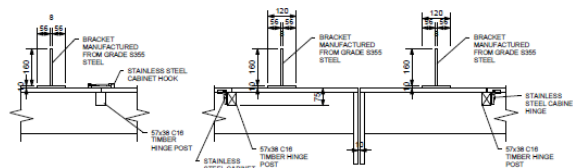

DETAIL 4
Scale: 1:10

DETAIL 5
Scale: 1:10

NOTES

1. ALL DIMENSIONS IN MILLIMETRES UNLESS NOTED OTHERWISE
2. CABINET TO BE MANUFACTURED FROM 18mm PLYWOOD TO COMPLY WITH EN 898 CLASS 3 FOR EXTERIOR CONDITIONS (EXPOSURE TO WEATHER OVER SUBSTANTIAL PERIODS OR CONTINUOUS EXPOSURE TO MOISTURE)
3. CABINET TO BE ASSEMBLED TOGETHER USING EXTERIOR GRADE WOOD SCREWING

PROJ	250622	CABINET SHELVING UPDATED	AT	MY	DT
PROJ DT	17-02-22	SUITABLE FOR STAGE APPROVAL	AT	MY	DT
REV	DATE	DESCRIPTION	BY	CHK	APP

REVISIONS

CLIENT

PROJECT
VATTENFALL KITTIWAKE STRUCTURES

TITLE
KITTIWAKE NESTING CABINET

RHD Commercial Sales, Greenway 04 8102
Leeds, Yorkshire LS10 4JZ
Tel: +44 (0)114 444 4000
Email: rhd@rhdh.com
Website: www.royalhaskoningdhv.com

DRAWN	AG	CHECKED	APPROVED
DATE	05/13/22	SCALE	As indicated
DRAWING No.	PC2765-RHD-KT-ZZ-DR-C-0003	SUITABILITY	REVISION
		S4	P02