

Hornsea Project Three
Offshore Wind Farm



Hornsea Project Three Offshore Wind Farm

Appendix 31 to Deadline I submission – Transport Assessment

PINS Document Reference: APP-159
APFP Regulation 5(2)(a)

Date: 7th November 2018

Document Control			
Document Properties			
Organisation	Ørsted Hornsea Project Three		
Author	RPS		
Checked by	Sarah Drljaca		
Approved by	Andrew Guyton		
Title	Appendix 31 to Deadline I submission – Transport Assessment		
Document Number	APP-159		
Version History			
Date	Version	Status	Description / Changes
14th May 2018	1	Final	Application Documents Submission
07 th November 2018	A	Final	Updated submission at Deadline 1 (07/11/2018) - Correction of typographical and clerical errors.

Liability

This report has been prepared by RPS, with all reasonable skill, care and diligence within the terms of their contracts with Ørsted Power (UK) Ltd.

Ørsted,
5 Howick Place,
London, SW1P 1WG

© Ørsted Power (UK) Ltd., 2018. All rights reserved

Front cover picture: Kite surfer near a UK offshore wind farm © Ørsted Hornsea Project Three (UK) Ltd., 2018

Table of Contents

1.	Transport Assessment.....	1
1.1	Introduction.....	1
1.2	Policy and guidance.....	2
1.3	Consultation.....	2
1.4	Baseline environment.....	2
1.5	Description of construction work.....	15
1.6	Transport impact of construction.....	23
1.7	Mitigation of transport impact.....	38
1.8	Development consent order.....	42
1.9	Summary and conclusion.....	43
Appendix A	HGV Vehicle Movements per Access Point.....	44
Appendix B	Traffic Flows.....	45
Appendix C	Network Peak Calculations with Construction Flows.....	46
Appendix D	Signalised Junction.....	47
Appendix E	LinSig Full Input Data and Results.....	48
Appendix F	Roundabout Operational Assessments.....	49
Appendix G	Index of Changes.....	50

List of Tables

Table 1.1:	Summary of accident rates.....	8
Table 1.2:	Existing Daily Traffic Flows.....	12
Table 1.3:	Summary of bus services within 800 m of Hornsea Three onshore cable corridor.....	14
Table 1.4:	Maximum design scenario considered for the assessment of potential impacts on traffic and transport.....	16
Table 1.5:	Cable Sections, Access Points and HGV Routes.....	18
Table 1.6:	Daily construction vehicle movements.....	26
Table 1.7:	Percentage impact of construction traffic – sensitivity testing.....	27
Table 1.8:	AM and PM construction peak impacts.....	30
Table 1.9:	Results of operational assessment of A140/B1113 signalised junction.....	32
Table 1.10:	Results of operational assessment of A148/B1149/B1110 junction.....	33
Table 1.11:	Results of operational assessment of B1149/B1145 four-arm roundabout.....	34
Table 1.12:	Measures adopted as part of Hornsea Three.....	40

List of Figures

Figure 1.1:	Indicative Shuttle Working Arrangements.....	35
Figure 1.2:	Indicative haul crossing route crossing.....	37

Glossary

Term	Definition
Abnormal Indivisible Loads	Loads or vehicles that exceed maximum vehicle weight, axle weight or dimensions as set out in the Road Vehicles (Construction and Use) Regulations 1986 (as amended).
Degree of Saturation	A measurement of the amount of capacity being used for movements through a signalised junction.
Geotextile	Textile matting laid under aggregate to provide coherence and stability to a temporary road surface.
Growthed	The application of traffic growth rates to traffic flows.
Highway Link	Length of highway of similar geometrical standards between two points.
Mean Max Queue	An indication of the typical extent of queuing for a movement through a signalised junction.
Measures adopted as part of the project	Enhancement, mitigation or monitoring commitment (which may include process or design measures) intended to avoid, reduce and where possible, remedy significant adverse impacts of a development.
NATA/WebTAG Methodology	A standard national approach to undertaking assessments of major transport infrastructure projects.
Onshore elements of Hornsea Three	Hornsea Three landfall area, onshore cable corridor, the onshore HVAC booster station, the onshore HVDC converter/HVAC substation and the interconnection with the Norwich Main National Grid substation.
Operational assessment	The assessment of the degree to which a junction is operating within its theoretical capacity.
Pedestrian Amenity	The convenience or comfort of movement on foot.
Practical Reserve Capacity	A measure of a signalised junction's total performance, where a positive number represents reserve capacity.
Ratio of flow to capacity	A measure of the operational performance of one arm of a junction calculated as the number of vehicles using an arm of a junction divided by the theoretical maximum number of vehicles that are able to use the arm during a specified period.
Serious personal injury accident	An accident leading to serious injuries requiring hospital treatment.
Severance	Real or perceived difficulties moving between one part of a community to another.
Shuttle working	The use of either manual control or traffic signals to allow alternate traffic streams to pass through a length of highway where the width is reduced and insufficient to allow two vehicles to pass each other.
Slight accident	An accident leading to slight injuries which are defined as cuts, bruises or sprains requiring roadside attention but not normally requiring admission to hospital.
TRACK Analysis	Computer modelling of area taken up by a moving vehicle.
Traffic growth rate	An estimate of the rate of change in traffic flows from one year to another year.
Transport Assessment	A transport assessment is a comprehensive and systematic process that sets out transport issues relating to a proposed development. It identifies what measures will be taken to deal with the anticipated transport impacts of the scheme and to improve accessibility and safety for all modes of travel, particularly for alternatives to the car such as walking, cycling and public transport.
Trip Generation	The number of vehicle movements into and out of a development.
Trip Assignment	The routes that vehicles take between a site and other areas.

Term	Definition
Trip Distribution	The proportion of vehicle trips between a site and other areas.
Trunk Road	A trunk road is a road maintained by a national government body, as distinct from the great majority of roads, which are maintained by local Highway Authorities.

Acronyms

Unit	Description
AADT	Annual average daily traffic
ATC	Automatic Traffic Counter
CoCP	Code of Construction Practice
CTMP	Construction Traffic Management Plan
DCO	Development Consent Order
DfT	Department for Transport
DMRB	Design Manual for Roads and Bridges
EIA	Environmental Impact Assessment
ES	Environmental Statement
HE	Highways England
HGV	Heavy Goods Vehicle
HVAC	High Voltage Alternating Current
HVDC	High Voltage Direct Current
IHT	Institution of Highways and Transportation
IPC	Infrastructure Planning Commission
LTP	Local Transport Plan
MCCs	Manual Classified Count
MD	Main Distributor
MHWS	Mean High Water Spring
NCC	Norfolk County Council
NCN	National Cycle Network
NPPF	National Planning Policy Framework
NPS	National Policy Statement

Unit	Description
NSIP	Nationally Significant Infrastructure Project
PINS	Planning Inspectorate
PEIR	Preliminary Environmental Information Report
PIA	Personal Injury Accident
SRN	Strategic Road Network
TT	Trenchless Technology
TEMPRO	Trip End Model Presentation Programme
WebTAG	Web Transport Analysis Guidance

Units

Unit	Description
km	Kilometre (distance)
m	Metre (distance)
mph	Miles per hour (speed)
PCU	Passenger Car Unit (traffic flow)
PCU/Hr	Passenger Car Unit per hour (traffic flow)
t	Tonnes (weight)

1. Transport Assessment

1.1 Introduction

1.1.1.1 This Transport Assessment (TA) assesses the transport impact of the construction phase of Hornsea Project Three off-shore wind farm (hereafter referred to as Hornsea Three). The report has been prepared as an annex to the Traffic and Transport Chapter of the Environmental Statement.

1.1.1.2 During the operational phase, the only vehicle movements generated will be maintenance visits, which will be typically one vehicle on an approximate weekly basis. These visits are likely to be made by light vehicles only and would use the existing road network and the permanent onshore HVAC booster station and HVDC converter/HVAC substation accesses constructed as part of Hornsea Three. One vehicle arrival per week is very low and infrequent and will not result in any highway capacity issues and an assessment of this is scoped out.

1.1.1.3 Vehicle movements generated during the decommissioning phase will be lower than those during the construction phase since the removal of materials does not need to be delicately transported and can be bulk loaded whilst some infrastructure will be retained in-situ. Given that some infrastructure will be left in-situ, this results in less transport requirement which results in fewer vehicle movements in comparison to the construction phase. All mitigation measures that are identified for the construction phase will also be adopted during the decommissioning phase, thus, for a maximum design scenario, it can be determined that the identification of impacts resulting from traffic generated during the construction phase, would also apply to the decommissioning phase. An assessment of the decommissioning phase specifically is therefore scoped out of this TA.

1.1.2 The traffic and transport study area

1.1.2.1 The Hornsea Three traffic and transport study area includes the onshore elements of Hornsea Three (i.e. the Hornsea Three landfall area, the onshore cable corridor, HVAC booster station, HVDC converter/HVAC substation and the interconnection with the Norwich Main National Grid Substation), together with the compounds (including main construction compound), storage areas, construction accesses and all highways, Public Rights of Way (PRoW), private accesses and railways in the vicinity that are anticipated to be used by, or affected by, the construction, operational and decommissioning traffic. The study area also includes parts of the wider transport network that provide links between the onshore cable corridor and onshore HVDC converter/HVAC substation site and the local and strategic transport networks. Road links within the study area are shown on Figures 7.1 and 7.2 in volume 3, chapter 7: Traffic and Transport.

1.1.2.2 The Hornsea Three traffic and transport study area includes all areas identified by Highways England (HE) and Norfolk County Council (NCC) Highway Authority in the course of consultation for Hornsea Three.

1.1.3 Project summary

1.1.3.1 The transport impact of the construction of the onshore elements of Hornsea Three, together with the compounds (including main construction compound) and storage areas is expected to be related to the movement of materials, equipment and staff and to temporary changes in the highway network where trenches are dug across highways. The temporary closures and diversions of PRoW required as part of the construction works are considered in volume 3, chapter 6: Land Use and Recreation.

1.1.3.2 The areas affected by the Hornsea Three onshore cable corridor, the onshore HVAC booster station and HVDC converter/HVAC substation are the responsibility of Norfolk County Council (NCC) and Highways England (HE). Discussions have been undertaken with the Highway Authorities (Highways England and Norfolk County Council) with regards to the sensitivity of the network, assessment requirements and mitigation. Since a significant proportion of the Heavy Good Vehicle (HGV) traffic associated with the construction is expected to use the A11 and A47, HE has also been consulted on the project. Details of scoping discussions and consultation are provided in section 7.6 of volume 3, chapter 7: Traffic and Transport.

1.1.3.3 The operation of the Hornsea Three onshore cable corridor will generate a negligible overall level of traffic compared with the baseline; however, there will be a noticeable increase in HGV movements on some links during the busiest periods of the construction phase of the project. The operation of the onshore HVAC booster station and HVDC converter/HVAC substation will generate a small number of staff trips with occasional maintenance vehicle movements. The decommissioning of the onshore elements of Hornsea Three will generate significantly less traffic than the construction phase as the onshore cable corridor will remain in-situ, therefore the TA is focused on the construction phase.

1.1.3.4 It is intended that the main consents and licenses associated with the implementation of the construction works for Hornsea Three will be obtained through the DCO process. The implications of this are discussed within this report.

1.1.3.5 The report concludes that works associated with the construction of the onshore elements of Hornsea Three, together with the compounds (including main construction compound), storage areas, construction accesses, would not lead to any significant transport impacts resulting from construction traffic. This includes the implementation of a number of mitigation measures relating to the timing of HGV movements, the routing of HGVs and the management of site access points. Some delays are expected to existing highway users, where for example accesses are being formed, and details of the traffic management measures proposed at each of these points have been identified. Suitable access arrangements for Hornsea Three landfall area, the onshore cable corridor (including secondary compounds), main compound, the onshore HVAC booster station and HVDC converter/HVAC substation construction sites have been identified. Details of the consultations with the relevant Highway Authorities and other consultees are set out in volume 3, chapter 7: Traffic and Transport Chapter.

1.1.3.6 The general scope of assessment and methodologies contained within this TA have been agreed in advance with NCC and HE. Due to their nature, some of the detailed elements, for example the configuration of trenches to result in a maximum design scenario, have not been discussed with NCC or HE in advance. However, for those detailed elements that have not been discussed in advance, industry standard practices have been adopted to ensure a maximum design scenario is created and relevant guidance documents have been followed such that a reasonable maximum impact is assessed appropriately and in accordance with those documents.

1.2 Policy and guidance

1.2.1.1 This TA has been prepared in accordance with the Overarching National Policy Statement (NPS) for Energy (EN-1) (DECC, 2011a) which states that if a project is likely to have significant transport implications, the applicant's ES should include a TA, using the NATA/WebTAG methodology stipulated in Department for Transport (DfT) guidance (DfT, 2007), or any successor to such methodology.

1.2.1.2 Accordingly, the TA has been prepared in accordance with the National Planning Policy Framework (NPPF) which states that *"all developments that generate significant amounts of movement should be supported by a Transport Statement or Transport Assessment"* and the National Planning Practice Guidance relating to Travel plans, TAs and statements in decision-taking.

1.2.1.3 Circular 02/2013: The Strategic Road Network and the Delivery of Sustainable Development was released in September 2013. The Circular sets out the way in which the Highways Agency will engage with communities and the development industry to deliver sustainable development and economic growth whilst safeguarding the primary function and purpose of the Strategic Road Network (SRN). Circular 02/2013 states that *"the Highways Agency supports the economy through the provision of a safe and reliable strategic road network, which allows for the efficient movement of people and goods"*. Similarly, to the NPPF, Circular 02/2013 states that *"development should only be prevented or refused on transport grounds where the residual cumulative impacts of development are severe"*.

1.2.1.4 Details of other relevant policies at national, regional and local level and relevant guidance documents are set out in volume 3, chapter 7: Traffic and Transport.

1.3 Consultation

1.3.1.1 HE and NCC as Highway Authority were consulted on the scope of the TA and this TA takes into account the responses received.

1.3.1.2 A summary of consultation responses, including those made by other consultees on the scope of the EIA is set out in Table 7.4 of volume 3, chapter 7: Traffic and Transport.

1.4 Baseline environment

1.4.1 Highway network

1.4.1.1 Details of the highway network are set out in annex 7.2: Description of Network Links and Sensitivity. The following paragraphs provide an overview of the strategic highway network and the highway network providing access to the onshore elements of Hornsea Three, the compounds (including main construction compound), and storage areas.

Strategic / Principal Road Network

1.4.1.2 The main routes into the Hornsea Three traffic and transport study area from the wider SRN are via the A47 that runs east-west between Kings Lynn and Great Yarmouth, and the A11 which routes from junction 9A of the M11 to Norwich City Centre. The A47 is primarily a wide single carriageway road, becoming a dual carriageway from its junction with the Dereham Road/Church Lane roundabout to Blofield, east of Norwich, where it returns to a wide single carriageway. The A11 is a dual carriageway road from its junction with the A47 to its junction with the M11, and is accessed from the A47 via a grade-separated junction.

1.4.1.3 The A1270 Northern Distributor Road is a dual carriageway strategic distributor road which routes from the A47 east of Norwich via a grade-separated junction, routing to the north of Norwich where it joins the A1067 via junctions for the A140 and B1149. The A140 and A1067 are key commuter roads between Norwich and North Norfolk within a highway network that has few trunk roads and A roads.

1.4.1.4 The A1270 Northern Distributor Road objectives are to reduce traffic levels and congestion on the existing road network, both within the urban area and beyond to the north. The A1270 opened in late 2017/early 2018 and allows traffic to route north of Norwich, bypassing the A1042 and A140 which route towards and around the city centre.

1.4.1.5 The NCC Route Hierarchy map, produced by NCC Highway Network Management sets out a hierarchy of road types with higher classifications of road being at the top and illustrates trunk roads and principal roads in addition to Main Distributor (MD), HGV, Tourist and Access roads throughout Norfolk. The classification of links which comprise the roads shown on the NCC Route Hierarchy map is shown at annex 7.8: Traffic and Transport Figures.

Access to Hornsea Three onshore cable corridor

1.4.1.6 The Hornsea Three onshore cable corridor will be accessed using roads listed on the NCC Route Hierarchy map wherever possible, although some use of narrow single carriageway and single-track roads will be necessary to reach some access points.

- 1.4.1.7 Up to two temporary haul roads (typically one per phase – see Table 7.9 and volume 1, chapter 3: Project Description) will be constructed along the majority of the Hornsea Three onshore cable corridor to provide for HGV access to undertake trenching works and install the cables, with gaps only at some HDD locations and road crossings. The haul road will enable vehicles to move along the Hornsea Three onshore cable corridor and relieve the need for construction traffic to rely on longer sections of the local road network during construction.
- 1.4.1.8 Access from the highway network will be necessary for the transportation of materials for the construction of the haul road. Construction access points from the road network to the Hornsea Three onshore cable corridor have sought to utilise existing field access points or where the onshore cable corridor crosses the public highway and are shown on Figure 1.2 at annex 7.8: Traffic and Transport Figures.
- 1.4.1.9 The Hornsea Three onshore cable corridor crosses a number of roads, disused railway lines and active railways. Major transport infrastructure including railways and all public roads would be crossed using HDD. HDD will also be used to cross features such as main rivers and ordinary watercourses, major drains and ecologically designated sites as shown on Figure 1.2 at annex 7.8: Traffic and Transport Figures. At HDD locations, temporary construction site accesses are located to ensure that access can continue to be provided to the whole route where an obstacle might prevent the installation of a haul road.
- 1.4.1.10 Access to the Hornsea Three onshore cable corridor and key transport links are described in 21 individual cable sections, each generally defined by a primary access route from the road network of A and/or B road classification to the onshore cable corridor. In most cases a cable section will have multiple accesses. These 21 cable sections are specific to Traffic and Transport and have only been defined to assist with access routeing and traffic generation.
- 1.4.1.11 The Hornsea Three onshore cable corridor with HDD and access locations, along with cable sections is shown on Figure 1.2 at annex 7.8: Traffic and Transport Figures.
- 1.4.1.12 The key roads are identified in the following paragraphs in order to provide an overview of some of the larger roads which will provide access to multiple sections of the Hornsea Three onshore cable corridor.
- 1.4.1.13 Sensitive receptors such as schools, care homes, hospitals and residential areas with poor footway provision have been identified within the vicinity of the Hornsea Three onshore cable corridor, at annex 7.8: Traffic and Transport Figures and highlighted in the following paragraphs.
- A149
- 1.4.1.14 The A149 runs parallel to the coastline, routing from Kings Lynn to Cromer via Hunstanton, then south east to Caister-on-Sea, and is a key commuter road between the coastal towns. It is identified on the Norfolk Route Hierarchy Map as a '3B3 – Special Access' road between Cromer and Hunstanton. The A149 provides a potential access route through Sheringham via the A1082, with good forward visibility and few sensitive receptors with the exception of Weybourne, which has some residential frontages and sensitive receptors with no footways. The A149 Sheringham Road runs underneath the former North Norfolk Railway Line; therefore, a railway bridge crossing over the A149 prevents vehicles over 4.3 m in height from accessing Weybourne from Sheringham via this route.
- 1.4.1.15 While the A149 is a principal road with good forward visibility and a wide carriageway, it routes through Cromer, an urban centre with a residential area, town centre, shops and schools. Residential frontages and a church access are located directly onto the main road, and a one-way system operates in the centre of Cromer. Eastbound vehicles route along the A149 Church Street, and westbound vehicles route along Loudon Road. There are several signal controlled crossing points on both of these routes enabling pedestrians to safely cross from residential areas to shops and schools. Car parking bays are present along the route; the carriageway which is unsuitable for parking due to width or activities, is controlled by double yellow lines.
- 1.4.1.16 The remainder of the A149 has few sensitive receptors and is subject to variable speed limits (40 mph, 50 mph and national speed limit).
- A148
- 1.4.1.17 The A148 routes northeast from Kings Lynn to Cromer via Fakenham. The A148 is one of the primary routes through North Norfolk and is a key commuter road for the rural communities and coastal towns.
- 1.4.1.18 The A148 will provide HGV access to narrow single carriageway and single track roads adjacent to the Hornsea Three onshore cable corridor between the A148 and Baconsthorpe. South of Baconsthorpe, HGVs can access the Hornsea Three onshore cable corridor via the B1149.
- A140
- 1.4.1.19 The A140 routes between the A149 junction located approximately 3.5 km south of Cromer to the B1145 junction south of Aylsham; from Aylsham the A140 routes south to Norwich. As a principal road with wide carriageways and good forward visibility, the A140 is a key commuter road into Norwich from North Norfolk. The speed limit of the A140 between Cromer and Norwich varies between 30 mph, 40 mph and the national speed limit.
- 1.4.1.20 The A140 routes through Roughton, a small village centre with shops and crossings, pub and church. The speed limit is reduced to 30 mph through this section, increasing to the national speed limit to the south of Roughton. Road width and forward visibility are retained through Roughton.
- B1436
- 1.4.1.21 The B1436 routes from the A148 via a three-arm roundabout, routeing south to the A140 at Roughton via a three-arm mini roundabout. The B1436 routes through Felbrigg and is primarily a national speed limit carriageway road; however, the speed limit reduces to 30 mph near Roughton within the vicinity of some sensitive receptors such as residential frontages and primary school.
- 1.4.1.22 The B1436 allows construction vehicles to route onto the A148 from the A140, bypassing Cromer which has many sensitive receptors and may be sensitive to changes in vehicle movements during peak tourist season.

A1067

1.4.1.23 The A1067 routes from the A148 east of Fakenham, southeast to the A140 and A1402 junctions in Norwich. The A1067 between Fakenham and Bawdeswell is a principal road with good forward visibility. The A1067 from Bawdeswell to the A140 is suitable for HGVs; it has good forward visibility, a suitable carriageway width and is used as an existing bus route. The speed limit varies between 30 mph, 40 mph, 50 mph and the national speed limit.

1.4.1.24 There are some sensitive receptors on this route as it routes into Norwich; however, the footways are wide within the vicinity of these sensitive receptors. The A1270 Northern Distributor Road is accessed from the A1067 via a three-arm roundabout; therefore, construction vehicles can route via the A148 and A1067 south and onto the lower section of the B1149 for some sections of the Hornsea Three onshore cable corridor.

B1149

1.4.1.25 The A148 provides access to the B1149 via four-arm roundabout in Holt. The B1149 routes between Holt and the A1270 Northern Distributor Road; however, it previously joined the A140 via a large three-arm roundabout west of Norwich International Airport. The construction of the A1270 Northern Distributor Road has resulted in the previous junction of the B1149 and A140 being blocked off, instead having the B1149 route onto the A1270 Northern Distributor Road and a separate grade-separated junction between the A1270 Northern Distributor Road and the A140 has been constructed.

1.4.1.26 The B1149 is a '3A2- Main Distributor' road and runs broadly parallel to the Hornsea Three onshore cable corridor as it routes from landfall to the A1067. There are some sensitive receptors on the B1149 as it passes through villages such as Edgefield, Saxthorpe and Horsford. The speed limit varies between 30 mph, 40 mph, 50 mph, and the national speed limit.

A47

1.4.1.27 The A47 is one of the few trunk roads within Norfolk, and routes from Kings Lynn to Great Yarmouth. The A47, routes to the south of Norwich within the vicinity of the Hornsea Three onshore cable corridor.

1.4.1.28 The A47 has typical characteristics of a trunk road, namely the national speed limit with a wide carriageway and few sensitive receptors. The A47 proves a key route for HGVs routing north and south along the onshore cable corridor as HGVs can route around Norwich via the A47 without travelling through the city centre or on minor roads.

1.4.1.29 The B1108, B1172, A11 and A140 have junctions with the A47 to the south west of Norwich and are included within the Hornsea Three traffic and transport study area.

A11

1.4.1.30 To the southwest of Norwich, the A11 routes southwest from the A147 junction and forms bypasses around Hethersett and Wymondham.

1.4.1.31 The B1172 routes from the A11 junction with the A47 along the south of Hethersett with a foot and cycle path north of the carriageway.

1.4.1.32 In general, the A11 has wide carriageways and few sensitive receptors, though some residential frontages are present. A good footway provision is present in the vicinity of dwellings.

B1145 from Aylsham to Bawdeswell

1.4.1.33 The B1145 is classified by NCC as a '3A2 – Main Distributor' road and is a key link to the A140 from Bawdeswell, Reepham and Cawston. A four-arm roundabout connects the B1145 to the A140 and Norwich Road. Routing west from Aylsham, the B1145 has a crossroad junction with the B1149 and a priority junction where it meets the A1067. The B1145 has generally good visibility with the exception of some bends on which visibility is reduced by high hedgerows and buildings. The speed limit varies between 20 mph, 30 mph, 40 mph, 50 mph and the national speed limit.

1.4.1.34 The B1145 provides an access route for HGVs between the Hornsea Three onshore cable corridor and the A140, with wide carriageways and street lighting within the vicinity of Aylsham.

1.4.1.35 The B1145 routes through the village of Cawston and Reepham town centre which have a number of sensitive receptors including shops, narrow footways and residential frontages. The speed limit is reduced to 20 mph as it routes through Reepham.

B1108 Earlham Road/Watton Road

1.4.1.36 The B1108 Earlham Road/Watton Road routes from the A47, west of Norwich, to Barford approximately 11.5 km from Norwich. The B1108 continues to route through Barford and to the southwest where it joins the A1065 at Bodney. Between the A47 and Barford, the B1108 has good forward visibility and width, with suitable footways either side of the carriageway in residential areas. The B1108 is a key commuter road from the west of Norwich into the city centre and its junction with the A147 via a four-arm roundabout enables access from the B1108 to the city centre.

1.4.1.37 The B1108 is classified as a '3A2 - Main Distributor' road within the NCC Route Hierarchy. On this section of road there is on-street parking, with footways and lighting, and numerous sensitive receptors including a hospital, church and direct access to residential dwellings.

Tourist Routes

1.4.1.38 The NCC Route Hierarchy map outlines several roads which are listed as tourist routes. These sections of the highway network will differ greatly in volumes and profiles of traffic between a typical working day, and during the summer season, particularly the peak summer holiday period between mid-July and September. It is considered that the seasonal variation will be greater on the highway network closer to the coast due to the limited number of alternative routes and specific tourist attractions.

Access to onshore cable corridor

- 1.4.1.39 To assist with the calculation of construction vehicle movements and the movement of these to the Hornsea Three onshore cable corridor, the onshore cable corridor has been separated into several sections, as shown in, annex 7.2: Description of Network Links.
- 1.4.1.40 The access points into the Hornsea Three traffic and transport study area are the A148 west, A1065, A47 west, A11, A140, A146 and A47 west. An additional access point is the A140/B1145 four-arm roundabout at Aylsham, which enables construction staff travelling from the A140 corridor between Norwich and Cromer to be incorporated into the traffic flow model. It is assumed that all construction traffic will route to the Hornsea Three onshore cable corridor via these external points on the network. This maximises the number of links within the study area that have HGV movements generated along them. This is because it forces all HGVs to arrive from outside the study area which maximises the number of road links they travel on within the study area. If HGVs were to originate from within the study area then those HGVs would not travel on road links between their origin and the outer edge of the study area.
- 1.4.1.41 The access routes in each section are summarised in the following paragraphs to clarify the extent of the local highway network being utilised. Access from the wider network will be taken via the strategic roads listed above.
- 1.4.1.42 Access to the Hornsea Three onshore cable corridor (including secondary compounds) and key transport links are described in 21 cable sections, with landfall, the onshore HVAC booster and HVDC converter/HVAC substations also discussed.

Hornsea Three landfall area

- 1.4.1.43 The Hornsea Three onshore cable corridor makes landfall at Weybourne, with access from the highway network taken via The Muckleburgh Museum, west of Weybourne. The museum has an existing 5 m wide access road, and an additional road will be constructed parallel to the existing road to allow for two-way HGV movements with minimal impact on the Museum. The military museum access is taken from the A148.
- 1.4.1.44 The primary route option for HGVs routeing from the A148 to the A149 is via the A1082 at Sheringham, where a four-arm roundabout enables construction vehicles to route onto the A149 and route west to Weybourne. The remainder of the local highway network consists of single track and narrow single carriageway roads which are less suitable for high numbers of HGV movements: The Church Street T-junction with the A149 at Weybourne has limited visibility to the left due to residential dwellings adjacent to the carriageway. Church Street routes to Holt Road and Holgate Hill which has residential frontages with a lack of pedestrian facilities. The remainder of Holt Road and Holgate Hill are narrow single carriageways with no frontage access or sensitive receptors. Therefore, to access the lower half of Cable Section 1 HDD locations, a haul road above will be utilised, or a construction access corridor which is not within the Hornsea Three onshore cable corridor will route around HDD points.

- 1.4.1.45 The A149 routes from the Foxhills camping access through the centre of Weybourne to the point at which the A149 becomes subject to the national speed limit. There are no pedestrian facilities between the camping site and Weybourne, and high hedgerows limit forward visibility on bends. There are many sensitive receptors and a lack of footways to village facilities such as shops, pubs and a church. There is on-street parking and houses which front straight onto the road in the village, with poor visibility for several houses with driveways; the speed limit varies between 20 mph and 30 mph.

Landfall to Holgate Hill (Cable Section 1)

- 1.4.1.46 From landfall to Holgate Hill, the local highway network utilised by the construction of this section of the Hornsea Three onshore cable corridor will utilise the A148 from the wider highway network. Access is taken from the A149 and from Holgate Hill.
- 1.4.1.47 The primary route option for HGVs from the A148 to the A149 will be taken via the four-arm roundabout at Sheringham; however, a railway bridge which crosses the A148 prevents vehicles over 4.3 m in height from accessing landfall and Cable Section 1. This will not be an issue for daily construction vehicles; however, the cable drums will have to be transported such that their transport height is less than 4.3 m.

Holgate Hill to woodland north east of High Kelling (Cable Section 2)

- 1.4.1.48 Access to Section 2 of the Hornsea Three onshore cable corridor will be taken via an existing agricultural access corridor from Bridge Street, northeast of Holt and west of High Kelling. The existing access, north of Holt Rugby Club, routes to Warren Road which provides access to residential dwellings, Warren Close and agricultural land. Warren Road routes from Bridge Street; however, utilising the farm track north of Holt rugby club results in HGVs avoiding residential dwellings, minimising the risk of conflict.

Woodland north east of High Kelling to woodland south of Church Road (Cable Section 3)

- 1.4.1.49 Access to Section 3 of the Hornsea Three onshore cable corridor will be taken from the A148 and from Manor House Road. The A148 is a principal road with wide carriageways, good forward visibility and few sensitive receptors within the vicinity of the onshore cable corridor. As the A148 routes south of Holt, some frontage access is taken directly from the principal road. The section of road necessary to access the Hornsea Three onshore cable corridor is subject to the national speed limit, with good visibility and few sensitive receptors.

Woodland South of Church Road to Woodland south and east of School Lane (Cable Section 4)

- 1.4.1.50 Access to Section 4 will be taken via Hempstead Road, accessed from the A148 at Holt. Hempstead Road is a '3B2 – Local Access' road as identified on the NCC Route Hierarchy map between the A148 and the Hornsea Three onshore cable corridor.
- 1.4.1.51 The north section of Hempstead Road routes from the A148 to the Hempstead Industrial Estate and has a 30 mph speed limit. To the south and east of the industrial estate, Hempstead Road becomes the national speed limit.

Woodland (east of School Lane) to Plumstead Road (Cable Section 5)

1.4.1.52 There are few points at which the highway network crosses the Hornsea Three onshore cable corridor on Cable Section 5; the roads which do are primarily narrow single carriageway or single-track roads. The landscape becomes increasingly rural and commuter or distributor roads are infrequent on sections of the cable corridor where there are few towns or villages.

1.4.1.53 Hempstead Road/Hole Farm Road and Plumstead Road route from the B1149 eastwards and provide access to the Hornsea Three onshore cable corridor.

Plumstead Road to the B1149 (Cable Section 6)

1.4.1.54 Cable section 6 routes from Plumstead Road to the B1149, and Access to this section of the Hornsea Three onshore cable corridor will be obtained from the existing access to the Organic Waste Processing Site, taken from the B1149 north of Saxthorpe and Corpusty. The B1149 is classified as a '3A2 – Main Distributor' road and is subject to the national speed limit in the vicinity of the site entrance.

1.4.1.55 Sweetbriar Lane routes from the B1149 eastwards towards the Hornsea Three onshore cable corridor; however, it is single track with few passing places. Accesses are located on Sweetbriar Lane and background traffic flows are not likely to be significant. Access is also taken from the B1149 and from the Organic Waste Processing Site access road.

1.4.1.56 Cable Section 6 has a temporary secondary compound associated with the onshore HVAC booster station. The vehicle movements associated with the temporary secondary compound have been included within the Cable section 6 calculations and will be discussed further in Section 5.

Onshore HVAC booster station

1.4.1.57 The onshore HVAC booster station is located north of the B1149 at Saxthorpe, situated within Cable Section 6. The access corridor from the B1149 to the onshore HVAC booster station utilises part of an existing access for an organic waste processing plant which has daily HGV movements associated with its operation.

B1149 to land south of Town Close Lane (HDD) (Cable Section 7)

1.4.1.58 Access to Section 7 will be taken primarily from the B1149 and B1354, both classified as '3A2 – Main Distributor' roads and subject to the national speed within the vicinity of the cable corridor. The B1149 and B1354 reduce to 30 mph at Saxthorpe.

1.4.1.59 The B1149 allows for two-way vehicle movements, but has no footways. The B1149 will provide access to several accesses of the Hornsea Three onshore cable corridor via single track and narrow single carriageway roads. Access from the B1149 is the only access point for this section of the route as shown in annex 7.2: Description of Network Links.

1.4.1.60 In general, the B1354 has wide carriageways and few sensitive receptors in the vicinity of the transport scoping area and is subject to the national speed limit. There are some sensitive receptors as the road routes through Melton Constable and Briston in the form of a school with narrow footways adjacent to the carriageway, and on-street parking which narrows the carriageway width; however, conditions in the vicinity of the onshore cable corridor are reasonable, with some frontage access, good visibility and negligible sensitive receptors.

Land south of Town Close Lane to woodland north of Reepham Road (Cable Section 8)

1.4.1.61 Much of the road network located on Section 8 varies between narrow single carriageway and single track roads; therefore, the use of the haul road as the primary means of access to the remainder of the Hornsea Three onshore cable corridor, rather than the use of the local highway network, is likely to be of increased importance on this section of the Hornsea Three onshore cable corridor.

1.4.1.62 Heydon Road is the primary access point to Cable Section 8, with single track roads routeing from Heydon Road also crossing the cable corridor. Heydon Road is classified as a '3B2- Local Access' road between the B1149 and onshore cable corridor.

Land north of Reepham Road to woodland north of Reepham (Cable Section 9)

1.4.1.63 Cable Section 9 will be accessed from Wood Dalling Road which routes from the B1145 via a priority junction, and has a small industrial estate approximately 100 m north of the B1145 junction. There are a small number of dwellings which take access from Wood Dalling Road. To the south, within 200 m of the B1145 junction, there are a small number of dwellings with frontage access taken from Wood Dalling Road; however, north of this the road is primarily for agricultural access.

Woodland north of Reepham to woodland at Booton Common (Cable Section 10)

1.4.1.64 The B1145 crosses the cable corridor and provides access to Section 10 of the onshore cable corridor. The B1145 is classified by NCC as a '3A2 - Main Distributor' road and routes from the B1149 via Cawston, with some sensitive receptors between the cable corridor and B1149. Cawston has some sensitive receptors including frontage access and a small village centre with narrow footways. The B1145 is a signed HGV route between the B1149 and a small industrial estate to the north of Cawston, accessed via Chapel Street.

1.4.1.65 All access points for Cable Section 10 will be taken from the B1145 Cawston Road. Two access points where the onshore cable corridor crosses the B1145 allows construction vehicles to access the cable section north of Marriott's Way. An additional access utilises an existing farm track taken from the B1145, northeast of Reepham, which routes southeast to Marriott's Way. The access is located adjacent to where the B1145 becomes the national speed limit from a 30 mph zone to the west at Reepham. The access avoids any sensitive receptors in Reepham, and is located on the outskirts of the town where there are few dwellings.

Woodland east of Reepham to The Grove (Cable Section 11)

1.4.1.66 Cable Section 11 is located to the southeast of Reepham. Access will be taken from the B1149 via Buxton Road, which turns to Church Road.

1.4.1.67 To the east, Buxton Road is identified as a '3B2 – Access' road as identified on the NCC Route Hierarchy map. The speed reduces from the national speed limit to 30 mph at Eastgate, within the vicinity of dwellings with frontage access and no footways.

The Grove to woodland south of Church Farm Lane (Cable Section 12)

1.4.1.68 Cable Section 12 can be accessed from Reepham Road, north of Lenwade and Alderford. Reepham Road routes from the A1067 via Station Road, which has some residential accesses and footway provision within the vicinity of dwellings, on the eastern side of the carriageway.

1.4.1.69 Section 12 of the Hornsea Three onshore cable corridor is relatively rural in nature; there are no principal, MD or HGV routes across this section; therefore, Reepham Road is the only access route available from the A1067 to Cable Section 12.

Woodland south of Church Farm Lane to River Wensum (Cable Section 13)

1.4.1.70 Cable Section 13 can be accessed from the A1067 via Porter's Lane from the west, and Old Fakenham Road leading to Station Road and Reepham Road from the east. Old Fakenham Road and Porter's Lane both route from the A1067, and are typical rural roads with no lane markings and hedgerows either side of the carriageway.

1.4.1.71 Station Road passes through the small village of Attlebridge, which features dwellings that are accessed directly from the road via driveways. The Marriott's Way cycle route, National Cycle Route 1, crosses Station Road north of Attlebridge and south of Alderford.

River Wensum to woodland south west of Ringland (Cable Section 14)

1.4.1.72 The A1067 crosses the Hornsea Three onshore cable corridor and provides access to Section 14 of the onshore cable corridor. It forms a junction with The Street at Attlebridge and construction vehicles can route onto The Street via its western junction with the A1067, which will avoid the residential area at the eastern junction between The Street and the A1067.

1.4.1.73 Marl Hill Road forms a junction with the A1067 west of Attlebridge. Marl Hill Road is a rural road with no road markings; little vegetation on the verges provides good forward visibility. Morton Lane and Ringland Lane are narrow rural roads with passing places. It gives access via Morton Lane and Ringland Lane.

Woodland south west of Ringland to A47 (Cable Section 15)

1.4.1.74 The A47 is a Trunk Road and gives access to Section 15 northwest of Easton, via Church Lane and Ringland Road. Church Lane is subject to the national speed limit and features two-way traffic with centre lines and leads to Ringland Road which gives access to Weston Road and Accesses A80 and A81. There are a small number of dwellings on this section of narrow rural road, with no footway provision.

1.4.1.75 Intwood Lane routes between the B1113 and a stream to the west. The cable will route through farmland from the stream to the B1113, with Intwood Lane being the only road which crosses the onshore cable corridor on this section.

A47 to Bawburgh Road (Cable Section 16)

1.4.1.76 Cable Section 16 is accessed from the A47 via Dereham Road, Church Lane and Marlingford Road. Church Lane is an unmarked rural road which is subject to the national speed limit, with some street lighting and a footway between Dereham Road and Saint Peter's church.

Bawburgh Road to woodland west of Little Melton (Cable Section 17)

1.4.1.77 Bawburgh Road forms a priority junction with a private track which travels southbound towards the B1108. The B1108 is a two-way rural road with centre lines, and is subject to the national speed limit. It is accessed via the A47, and with the exception of a small number of sparsely distributed dwellings, the B1108 does not pass through any sensitive receptors between the A47 junction and the onshore cable corridor. Access to Cable Section 17 will be taken directly from the B1108, or via Bawburgh Road which routes north from the B1108, crossing the onshore cable corridor.

Woodland west of Little Melton to A11 (Cable Section 18)

1.4.1.78 Cable Section 18 of the onshore cable corridor runs nearby to the western residential areas of Little Melton, and so to lessen the impacts on sensitive receptors, the majority of this section's construction vehicle movements will occur on the haul road.

1.4.1.79 The B1172 is accessible from the A47 and A11 at the Thickthorn Interchange, and gives direct access to the cable corridor. The road is subject to the national speed limit, features two-way traffic with centre lines, and a footway on its northern side. The B1172 contains a small number of dwellings from the Thickthorn Interchange to Station Lane, which are all set back from the carriageway.

1.4.1.80 As the B1172 routes into Hethersett it becomes subject to a 40 mph speed limit, and forms a junction with Station Lane. Station Lane leads to the cable corridor, and is a narrow rural road with high hedgerows. Access is achieved via an existing track, which passes a small number of dwellings.

A11 to woodland north west of Swardeston (Cable Section 19)

1.4.1.81 Cable Section 19 is accessed from Station Lane, which itself is accessed from the southern side of the A11 with deceleration and acceleration lanes. The A11 is a trunk road, and the section that passes through Section 19 is dual carriageway and subject to the national speed limit.

1.4.1.82 Station Lane routes broadly north-south and features two-way traffic with a centre line from its junction with the A11 and its junction with the Ketteringham Recycling Centre access road. From this junction, Station Lane continues as a wide rural road, with good forward visibility. The cable corridor is accessed from Cantley Lane which forms a bifurcated junction with Station Lane. Cantley Lane is a rural road with no markings and good forward visibility.

Woodland north west of Swardeston to B1113 (Cable Section 20)

1.4.1.83 Cable Section 20 is accessed from the B1113. Construction vehicles will route from the A47 via the northbound exit to the A140. This section of the A47 is dual carriageway and is subject to the national speed limit. The A47 forms a priority roundabout with the A140 following a deceleration lane, and then routes northbound to from a signalised junction with the B1113. The routes to the Hornsea Three onshore cable corridor and features a two-way carriageway with centre lines.

1.4.1.84 Approximately 150 m north of the cable corridor, there is a bridge where the A47 passes over the B1113. This bridge will not impact on the HGV movements towards the Hornsea Three onshore cable corridor. Access will be achieved from the B1113 via Short Lane, The Common and Intwood Lane. All three roads are typical narrow rural roads with high vegetation on the verges.

B1113 to end of Hornsea Three onshore cable corridor (Cable Section 21)

1.4.1.85 Access will be taken from the previously discussed B1113, a national speed limit '3A2 - Main Distributor' road with good visibility. The access point for the onshore HVDC converter/HVAC substation will be the access point for Cable Section 21. Access points located on Mangreen Lane are not suitable for large HGV movements, therefore these access points will not be used by HGVs.

1.4.1.86 The A140 will be utilised to route to the Hornsea Three onshore cable corridor, and is subject to the national speed limit. It forms a junction with Mangreen Lane, which after approximately 60 m from the A140 forms an access. This utilises the existing Norwich Main Substation access road.

Onshore HVDC converter/HVAC substation

1.4.1.87 Access to the permanent onshore HVDC converter/HVAC substation, Access A118, will be taken from the previously discussed B1113, a national speed limit '3A2 - Main Distributor' road with good visibility. A permanent access will be designed as vehicle movements associated with the operation of the onshore HVDC converter/HVAC substation will occur daily. The design access will incorporate a temporary wide access which will allow abnormal indivisible loads such as the transformers to enter the site, and the operational access will be instated once construction of the onshore HVAC converter/HVAC substation has been completed.

Main Compound at Oulton Street

1.4.1.88 The main compound at Oulton Street is currently accessed from The Street and Oulton Street, which routes broadly north to south between Blickling Road and the B1149. Traffic management measures will be developed as part of the subsequent Construction Traffic Management Plans (CTMPs) secured prior to the commencement of works and activities at the main compound, when the scope of the use of the main construction compound by the principal contractor is known. These traffic management measures may involve diversion routes.

1.4.2 Personal injury accidents

1.4.2.1 Personal Injury Accident (PIA) data has been used to consider the road safety record of the study area.

1.4.2.2 The area of analysis is over a significantly large area and therefore a two-stage process is undertaken as follows. After breaking the network into links, the injury accident rate was calculated and compared to the national average injury accident rate set out in Table RAS1002 of the Department for Transport (DfT) document 'Reported Road Casualties Great Britain 2016'.

1.4.2.3 This initial analysis was undertaken using PIA's from the Crashmap website for 2013, 2014 and 2015 and the injury accident rates are contained in Table 1.1.

Table 1.1: Summary of accident rates.

Link	AADT ^a	Link Length (km)	PIAs over 3 years ^b	PIAs per million vehicle-km (observed)	PIAs per million vehicle km (national average)
A148, west of The Street and east of Green Lane	12797	2.3	3	93	152
A148 west of Holt and east of Letheringsett	10550	10.2	11	94	152
A148, east of the B1149 roundabout and west of Station Road	11264	0.35	0	0	152
B1354 between the Swanton Road junction and B1110 junctions	3714	2.4	3	308	274
B1354 east of Melton Constable and west of Briston	5151	0.6	1	296	274
B1149 at Edgefield, north of the village hall and south of Hempstead Road	4174	0.5	2	878 ^c	274
A148 at High Kelling, south of Kelling Hospital	12783	0.6	1	119	152
A148, east of Bodham and west of the Woodlands Leisure centre	12179	0.5	1	150	152
A148, west of the B1436 junction and east of the Lion's Mouth junction	13200	1.1	2	126	152
B1436, east of Felbrigg	8893	2.2	1	47	274
A140, south of Roughton and north of the Topshill Road junction	11079	2.7	3	92	152
A149 west of Weybourne and east of The Pheasant hotel	3282	1.1	0	0	152
A149 east of Weybourne, west of the North Norfolk Railway line	4390	3.5	3	179	152

Link	AADT ^a	Link Length (km)	PIAs over 3 years ^b	PIAs per million vehicle-km (observed)	PIAs per million vehicle km (national average)
A1067, north of Bridge Road and east of Little Ryburgh	8696	2	2	105	152
B1145 at Bawdeswell, between The Street junction and Hall Road junction	3119	0.45	0	0	274
B1145, west of Reepham and east of the Old Lane junction	2742	2.7	2	247	274
B1145 east of Cawston, west of the B1149 crossroads	3199	1.5	3	573 ^c	274
B1145 east of the B1149 crossroads junction, west of Cawston Park Hospital	4448	4	7	360 ^c	274
A140, south of Aylsham's B1145/A140 roundabout, and north of Marsham	14475	1.4	2	90	152
A1067, between Attlebridge and the Fir Covert Road junction	8276	2.9	3	114	152
A140 between the A47 and B1113 junctions	22881	0.6	0	0	473
B1113, south of the A47 near Norwich Sports ground	8141	1.8	2	125	448
A47 at Honingham	27245	1.6	5	105	473
A47 at Bawburgh	43804	2.2	2	19	473
A47 at Intwood	52775	3.4	17	87	473
A11 at Hethersett	48817	1.9	5	49	473
A1065 south of A148 and north of Pond Road	7854	1.3	0	0	473
A140 north of Hevingham	12500	1.5	4	195	473
A1067 at Lenwade	11778	2.5	5	156	473
A1065 at Weasenham, between B1145 and Massingham Road	5050	3.5	4	207	473
^a Annual average daily traffic (AADT) derived from traffic surveys/DfT flows ^b Information obtained from Crashmap website ^c Links with accident rates more than 25% above the national average					

1.4.2.4 Where observed accident rates are in excess of national averages this does not necessarily indicate a poor safety record. Indeed, because they are an average, this means that 50% of all roads will have an injury accident rate that exceeds the average.

1.4.2.5 For robustness, injury accident rates that were 25% higher than the national average rates have been assessed further as a second stage of the analysis.

1.4.2.6 Therefore, four links have been identified as having an injury accident rate of 25% higher than the national average and these links have been analysed in further detail, along with injury accidents occurring on the A47 trunk road.

1.4.2.7 To undertake this analysis, PIA data has been obtained from NCC and analysed for the five-year period 01 December 2012 to 30 November 2017. Annex 7.4: Personal Injury Accident Locations shows a summary of the PIA records with details as follows. The roundabout, junctions or roads discussed below have a corresponding figure in volume 6, annex 7.8: Traffic and Transport Figures. The numbered PIA below (e.g. PIA 28) correspond to the PIA shown on these figures.

A11/A47 Roundabout

1.4.2.8 The injury accident data supplied covers the entirety of the A11/A47 Thickthorn Interchange. This includes Thickthorn Interchange junctions with; Newmarket Road, the A11, the A47, Cantley Lane South, and the B1172. This data also covers the B1172 roundabout with Thickthorn Park and Ride, Thickthorn Bus Station, Travelodge Norwich Cringleford, and the service station.

1.4.2.9 Annex 7.8: Traffic and Transport Figures indicates the location, severity and vehicles involved in each PIA. There were 31 PIAs in the search over the 5-year period. Of these PIAs, two were serious and there were no fatalities.

1.4.2.10 The first serious accident, shown as PIA 28, occurred on the Thickthorn Interchange exit to the A47 southbound, and was the result of a motorcycle heading for the A11 westbound failing to give way to a car heading towards the A47 southbound. The other serious accident, PIA 11, was the result of a car failing to stop and shunting the rear of a stationary car on the A11 junction to the Thickthorn Interchange. The shunt pushed the stationary vehicle into the path of oncoming vehicles on the roundabout, causing a collision with a third car. Both these serious accidents were the result of driver error.

1.4.2.11 Of the 29 slight accidents, four involved goods vehicles. Two of these accidents were the result of drivers failing to give way, and two were due to drivers failing to judge speed. These accidents were the result of driver error.

1.4.2.12 At the B1172 roundabout with Thickthorn Park and Ride, there were two slight accidents which were the result of drivers not driving to suit the road conditions, and another failing to give way or judge another vehicle's speed. There is one slight accident that occurred at the Park and Ride/Thickthorn Services roundabout, which was the result of a motorcyclist losing control.

- 1.4.2.13 The analysis shows a cluster of accidents at the western slip-road from the A11 to the Thickthorn Interchange. Four of these accidents are attributed to rear end shunts, and two are the result of drivers failing to give way.
- 1.4.2.14 Four slight accidents occurred on the A47 flyover. One accident was the result of a driver not driving to suit the road conditions, two were the result of drivers failing to judge other persons speed or to give way, and one was due to an electrical fault reducing visibility of a stationary car.
- 1.4.2.15 From the analysis undertaken at this junction, it appears that driver error is the common factor in the PIA data obtained. There is nothing in relation to the existing highway layout or geometries that raise a road safety concern.
- A47 between Sandy Lane and the B1535 junctions (inclusive of junctions)**
- 1.4.2.16 The injury accident data supplied covers the A47 between Sandy Lane and the B1535, inclusive of the junctions. Annex 7.8: Traffic and Transport Figures indicates the location, severity and vehicles involved in each PIA. There were 21 PIAs in the search over the 5-year period. Of these PIAs, one was fatal and four were serious.
- 1.4.2.17 The fatal incident occurred on the A47 junction with Wood Lane, and is shown as PIA 18. This was the result of a car turning right into Wood Lane from the A47 colliding with a motorcycle travelling southbound on the A47.
- 1.4.2.18 Over the period, there were four serious accidents. Two serious accidents occurred near the A47/Sandy Lane junction, PIA 2 and 3. These were the result of careless driving and failure to judge speed. Serious accidents PIA 6 and 10 occurred on the A47 between the Sandy Lane and the B1535 junctions. One was due to loss of control, and the other was the result of a driver failing to judge another vehicle's speed.
- 1.4.2.19 There were nine accidents involving goods vehicles. Two of these accidents involved good vehicles over 7.5 t and were both the result of the driver's failure to judge speed. Three involved goods vehicles of unknown weight and were also due to the driver's failure to look and judge speed.
- 1.4.2.20 There is a cluster of accidents near the A47/Church Lane junction, which all occurred on the A47 carriageway, and were all the result of the driver's failure to look and/or judge speed.
- 1.4.2.21 Two slight accidents occurred at the A47/Berry's Lane junction, and both contributing factors were drivers failing to judge speed.
- 1.4.2.22 Four slight accidents are recorded at the A47/Wood Lane junction in which the contributing factors were driver's failure to look or judge speed of other vehicles.
- 1.4.2.23 From the analysis undertaken at this section of the road network, it appears that driver error is the common factor. There is nothing in relation to the existing highway layout or geometries that raise a road safety concern.

A47/A146 Junction

- 1.4.2.24 The PIA data covers the junction between the A146/Loddon Road and the A47/Norwich Southern Bypass. at annex 7.8: Traffic and Transport Figures indicates the location, severity and vehicles involved in each PIA. There were 24 PIAs within the 5-year period; three were serious and there were no fatalities.
- 1.4.2.25 The serious injury accident which occurred on the A47 travelling south-east to north-east was the result of a bus or coach driver failing to slow in time, causing a collision with the back of a stationary car. East of this collision, another serious accident occurred after a driver lost control over a flooded section of road resulting from a blocked storm drain. The serious accident that occurred on the A47 eastbound slip road to the A146 was the result of a driver failing to give way at the signalised junction, and subsequently colliding with a car travelling south east to northwest on the A146.
- 1.4.2.26 There are four slight accidents involving goods vehicles, all of which were under 3.5 t. Accidents numbered 10 and 18 were the result of driver's failure to stop at a red light, and snowy conditions were a contributing factor in drivers failing to stop in accidents 13 and 23.
- 1.4.2.27 There are two distinct clusters within the area. The first cluster is the A47 northbound exit slip road signalised junction with the A146; These PIAs are the result of driver error, as all these accidents are attributed to drivers failing to stop at a red-light signal.
- 1.4.2.28 Another cluster is at the A47 southbound exit slip road signalised junction with the A146/Loddon Road. These accidents are all shown to be the result of drivers failing to stop at a red light.
- 1.4.2.29 From the analysis undertaken at this section of the road network, it appears that driver error is the common factor in the PIA data obtained. There is nothing in relation to the existing highway layout or geometries that raise a road safety concern.
- A148/B1454 junction**
- 1.4.2.30 This data covers the junctions between the A148 and the B1454, and the A148 and Elm Lane. Annex 7.8: Traffic and Transport Figures indicates the location, severity and vehicles involved for each PIA. There were 6 injury accidents within the most recent 5-year period. Of these PIAs, three were serious and there were no fatalities.
- 1.4.2.31 The serious PIA shown as 2 was the result of a driver failing to give way to a car turning around on the B1454, causing a collision. The serious PIA denoted as 3, was the consequence of a driver failing to give way turning right from the A148 to the B1454. PIA 6 was due to ice on the A148 causing the goods vehicle to slide into the path of an oncoming car.
- 1.4.2.32 The main contributing factor of the remaining slight PIAs is shown to be drivers failing to stop and/or judge another vehicle's speed.
- 1.4.2.33 From the analysis undertaken at this section of the road network, it appears that driver error is the common factor in the PIA data obtained. There is nothing in relation to the existing highway layout or geometries that raise a road safety concern.

B1145 - Reepham to B1149

- 1.4.2.34 The data covers the B1149 between Aylsham Road and Buxton Road, and B1145 between the B1149 and Orchard Lane. Annex 7.8: Traffic and Transport Figures indicates the location, severity and vehicles involved for each PIA. There were 15 PIAs over the 5-year period; one was serious and there were no fatalities.
- 1.4.2.35 The only serious injury accident, denoted as PIA 6, occurred after a driver lost control on a wet road, and subsequently collided with an oncoming car. The only PIA involving a goods vehicle was under 3.5 t and is denoted as PIA 4 and was the result of the goods vehicle failing to judge a car's speed, resulting in a rear end shunt.
- 1.4.2.36 Annex 7.8: Traffic and Transport Figures does not demonstrate any clusters of injury accidents.

Aylsham B1145 and A140

- 1.4.2.37 This data covers the B1145 between Holt Road and the A140, and the A140 between the B1145 and Banningham Road. Annex 7.8: Traffic and Transport Figures indicates the location, severity and vehicles involved in each PIA; there were 32 PIAs over the 5-year period; of these PIAs, eight were serious and there were no fatalities.
- 1.4.2.38 The first serious, denoted as 1 on the B1145, was the result of a driver losing control of their car after making contact with the verge. East of this accident, a serious accident was the result of a motorcyclist losing control at the right-hand bend travelling eastbound. The two remaining serious accidents on the B1145 were both due to a loss of traction pertaining to the road surface; PIA 9 involved a motorcyclist losing control after coming into contact with mud on the road, and PIA 11 occurred after a driver lost control on a bend in icy conditions. These serious accidents on the B1145 are all shown to be the result of drivers not driving to suit the conditions, or driving carelessly.
- 1.4.2.39 There were four serious accidents on the A140. Serious PIA 23 was the result of a car driver turning right from Buxton Road to the A140 across the path of a motorcyclist travelling southbound on the A140. PIA 25 occurred at the roundabout between the A140 and Burgh Road, and involved one car losing control at the roundabout. Two further serious accidents on the A140, PIA 24 and 31, both occurred previous to the construction of the current roundabout at the junction between the A140 and Burgh Road. These accidents occurred at the previous crossroad design, and were both the result of careless driving.
- 1.4.2.40 There was a cluster of slight accidents alongside these serious accidents. However, PIA 25 is the only accident to have occurred since the roundabout has been built and, except for PIA 28 which occurred during construction, the remaining accidents occurred at the previous crossroads.

- 1.4.2.41 There are four serious and nine slight accidents on the B1145 between the junction with the B1149 and the roundabout with Woodgate Way/Hobart Lane. With the exception of PIA 13 which involved a pedestrian, the accidents along this link mostly involved only one vehicle, and were due to drivers losing control by not driving to suit the conditions or speeding. The contributing factor of the PIA which involved a pedestrian was a driver not seeing the pedestrian, who was not wearing illuminated/reflective clothing, walking in the road in the dark.

B1149 Holt to Oulton

- 1.4.2.42 The data covers the B1149 between the A148/B110 roundabout and Heydon Road, inclusive of junctions. The search area also includes the B1354 between its junction with the B1149 and Tithe Barn Lane as shown at annex 7.8: Traffic and Transport Figures. indicates the location, severity and vehicles involved in each PIA. There were 27 PIAs in the search over the 5-year period. Of these PIAs, two were fatal and seven were serious.
- 1.4.2.43 A fatal accident occurred south of Saxthorpe on the B1149, shown as PIA 7. This was the result of a car losing control travelling southbound in wet conditions, and colliding head on with a car going northbound. A fatal accident occurred south of the B1149 junction with Hunworth Road, shown as PIA 25. This was the result of a driver losing control and colliding with a tree whilst exiting a right-hand bend travelling southbound.
- 1.4.2.44 There are three serious accidents within a cluster to the south of Saxthorpe, denoted as PIA 2, 3 and 5. The contributing factor to these three accidents is shown as being a deer or an unspecified animal in the carriageway.
- 1.4.2.45 Serious PIA 13 was the result of a driver losing control by failing to drive to suit the wet conditions. Serious PIA 15 was also due to a driver not driving to suit the conditions, as the car lost control on the icy road surface. Serious PIA 16 was the result of a motorcycle travelling at excessive speeds for a bend in the road.
- 1.4.2.46 The serious PIA 27 close to the B1149 junction with Hunworth Road occurred after a driver travelling around the bend at excessive speed lost control and collided head on with an oncoming car.
- 1.4.2.47 There were 14 slight accidents on the B1149 section of the surveyed area. Ten of these incidents were due to drivers losing control, with three of these being in wet conditions and another occurring in snowy conditions. Three accidents were the result of drivers failing to look, and another was a HGV failing to give way to a tractor.
- 1.4.2.48 On the studied section of the B1354, there were three slight accidents. Two were a result of drivers failing to drive to suit the conditions (wet and snowy), and the other occurred after a driver failed to see a broken-down car in the road.

1.4.3 Existing traffic flows

1.4.3.1 In order to establish baseline traffic flow models, traffic surveys were undertaken at various points across the transport study area. 12 Manual Classified Counts undertaken between 07:00 and 19:00 on Tuesday 13 June 2017 to establish a baseline scenario from which the impact of construction traffic on highway capacity could be assessed. The junctions surveyed are as follows:

- A148/A1067/Thorpland Road four-arm roundabout;
- A148/B1354 priority junction;
- A148/B1110/B1149 four-arm roundabout at Holt;
- B1354/B1110 staggered crossroads west of Melton Constable;
- A1067/B1110 bifurcated junction at Guist;
- A148/B1436 three-arm roundabout southwest of Cromer;
- A140/B1436 mini-roundabout at Roughton;
- A1067/B1145 T-junction, south of Bawdeswell;
- B1149/B1145 roundabout four-arm roundabout east of Cawston;
- A140/B1145/Norwich Road roundabout, south of Aylsham; and
- A140/B1113 signalised junction, north of the Tesco superstore.

1.4.3.2 These traffic surveys have been agreed with NCC and annex 7.3: Base Traffic Flows summarises the traffic flow information collected as part of the TA. Daily traffic flows for 22 sites were obtained through the use of Automatic Traffic Counters as various points across the transport study area, primarily on principal and MD roads to the north of Norwich. Daily traffic flows at 4 sites have been obtained from the DfT website. Daily traffic flows at four sites were obtained by HE and the remaining data was extracted from the NCC Northern Distributor Road TA.

1.4.3.3 Table 1.2 summarises the 2017 daily traffic flow information collected as part of the assessment process.

Table 1.2: Existing Daily Traffic Flows.

Link Description	Source	2017 Traffic Flows		
		Total	HGV	HGV % of Total
Link ID 35: A148, west of The Street and east of Green Lane	Automatic Traffic Counter	12797	771	6.0%
Link ID 34: A148 west of Holt and east of Letheringsett	Automatic Traffic Counter	10550	636	6.0%
Link ID 36: A148, east of the B1149 roundabout and west of Station Road	Automatic Traffic Counter	11264	563	5.0%

Link Description	Source	2017 Traffic Flows		
		Total	HGV	HGV % of Total
Link ID 50: B1354 between the Swanton Road junction and B1110 junctions	Automatic Traffic Counter	3714	268	7.2%
Link ID 55: B1354 east of Melton Constable and west of Briston	Automatic Traffic Counter	5151	372	7.2%
Link ID 59: B1149 at Edgefield, north of the village hall and south of Hempstead Road	Automatic Traffic Counter	4174	159	3.8%
Link ID 37: A148 at High Kelling, south of Kelling Hospital	Automatic Traffic Counter	12783	638	5.0%
Link ID 41: A148, east of Bodham and west of the Woodlands Leisure centre	Automatic Traffic Counter	12179	655	5.4%
Link ID 43: A148, west of the B1436 junction and east of the Lion's Mouth junction	Automatic Traffic Counter	13200	594	4.5%
Link ID 190: B1436, east of Felbrigg	Automatic Traffic Counter	8893	449	5.0%
Link ID 49: A140, south of Roughton and north of the Topshill Road junction	Automatic Traffic Counter	11079	546	4.9%
Link ID 1: A149 west of Weybourne and east of The Pheasant Hotel	Automatic Traffic Counter	3282	23	0.7%
Link ID 2: A149 east of Weybourne, west of the North Norfolk Railway Line	Automatic Traffic Counter	4390	30	0.7%
Link ID 81: A1067, north of Bridge Road and east of Little Ryburgh	Automatic Traffic Counter	8696	499	5.7%
Link ID 84: B1145 at Bawdeswell, between The Street junction and Hall Road junction	Automatic Traffic Counter	3119	118	3.8%
Link ID 86: B1145, west of Reepham and east of the Old Lane junction	Automatic Traffic Counter	2742	104	3.8%
Link ID 90: B1145 east of Cawston, west of the B1149 crossroads	Automatic Traffic Counter	3199	117	3.7%
Link ID 78: B1145 east of the B1149 crossroads junction, west of Cawston Park Hospital	Automatic Traffic Counter	4448	150	3.4%
Link ID 118: A140, south of Aylsham's B1145 / A140 roundabout, and north of Marsham	Automatic Traffic Counter	14475	690	4.8%
Link ID 111: A1067, between Attlebridge and the Fir Covert Road junction	Automatic Traffic Counter	8276	576	7.0%
Link ID 145: A140 between the A47 and B1113 junctions	Automatic Traffic Counter	22881	1209	5.3%

Link Description	Source	2017 Traffic Flows		
		Total	HGV	HGV % of Total
Link ID 146: B1113, south of the A47 near Norwich Sports ground	Automatic Traffic Counter	8141	277	3.4%
Link ID 129: A47 at Honingham	Highways England	27245	2664	9.8%
Link ID 157: A47 at Bawburgh	Highways England	43804	3126	7.1%
Link ID 147: A47 at Intwood	Highways England	52775	4112	7.8%
Link ID 153: A11 at Hethersett	Highways England	48817	4114	8.4%
Link ID 144: A47, between A140 and A146 junctions	Department for Transport	50123	2873	5.7%
Link ID 197: A1065, North of Swaffham	Department for Transport	7669	488	6.4%
Link ID 195: A1065, east of Weasenham	Department for Transport	5134	446	8.7%
Link ID 5: A1082, South of Sheringham	Department for Transport	8085	110	1.4%

- 1.4.3.4 NCC advise that there are seasonal variations in traffic flows on the A149 and A148. The A140 runs north to south between the coastal town of Cromer and Norwich. The A148 runs from Cromer roughly on a southwest route to Kings Lynn, whilst the A149 again runs from Cromer, due west following the coastline, before turning to Kings Lynn. All three routes pass through the Norfolk Coast Area of Outstanding Natural beauty and converge on the popular seaside town of Cromer.
- 1.4.3.5 NCC do not hold any traffic data along the A149 or A148 on which to determine the extent of any seasonal variation along the key coastal areas.
- 1.4.3.6 There are some DfT permanent traffic counters on each of the above roads, but these only provide year on year Annual Average Daily Flow figures rather than information relating to seasonal flow variation. HE provide network journey time and traffic flow data via their web site WebTRIS. However, on interrogating the WebTRIS database (March 2018) at the time of writing there are no count sites on any of the above routes.
- 1.4.3.7 An analysis of the traffic survey data shows that annual average traffic flows are very low in the areas to the north of Norwich and they do not identify any distinct AM or PM peak hours. Although there are peaks, they are not as defined as on other parts of the network. Observations indicate that there are no existing highway capacity problems in this area under annual average conditions.

1.4.3.8 It is understood from NCC that traffic flows are higher during the peak summer season, (mid-July to September) however, there is no data available on which to quantify the full extent of this. On the basis that traffic surveys have been undertaken outside of the peak summer season, the change in traffic flows as a result of the Hornsea Three construction vehicles relative to the baseline traffic flows are at a maximum and therefore represent the biggest impact in comparison to comparable traffic flows during the tourist season. As set out in the EIA methodology (volume 3, chapter 7: Traffic and Transport, section 7.9), this will therefore be a robust assessment in terms of the rule 1 and rule 2 thresholds and thus identify the key road links for detailed assessment robustly. The peak tourist season increases the number of cars along these sections and although this results in higher total vehicle flows, the number of HGV movements remain similar since there is no such increase in freight movement. Because the majority of traffic generated by Hornsea Three are HGVs, the conclusions of the EIA drawn from the detailed assessments undertaken in volume 3, chapter 7: Traffic and Transport, sections 7.11 and 7.13 are subsequently weighted towards HGV movements and thus the conclusions of the EIA (volume 3, chapter 7: Traffic and Transport) do not change as a result of peak seasonal traffic flows.

1.4.3.9 From a highway capacity perspective, the requirement for detailed assessment considers the change in traffic flow as a result of the construction traffic flows and thus is dependent upon these volumes. The construction traffic flow volumes do not alter due to the peak seasonal traffic flows and thus the conclusions drawn in this regard similarly do not change.

1.4.4 Public transport services

- 1.4.4.1 Annex 7.8: Traffic and Transport Figures summarises bus routes in the vicinity of the Hornsea Three onshore cable corridor and the closest bus stop on each route if it lies within 800 m of the onshore cable corridor.
- 1.4.4.2 800 m is a distance adopted based upon a mix of guidance and professional judgement. 400 m is a target walking distance (Institution of Highways and Transportation (IHT), 1999. *Guidelines for Planning for Public Transport in Developments*) to achieve for new developments and that is generally accepted as a reasonable walking distance in urban areas. Some people will walk longer than this distance and especially in rural areas, walking distances can be expected to be slightly longer for such areas. A distance of 800 m is therefore considered reasonable for the purposes of accessibility in this location.
- 1.4.4.3 Details of the bus services within 800 m of the Hornsea Three onshore cable corridor are summarised in Table 1.3. There are no other bus services within 800m of the Hornsea Three onshore cable corridor that are not listed in Table 1.3.

Table 1.3: Summary of bus services within 800 m of Hornsea Three onshore cable corridor.

Stop (if within 800 m of onshore cable corridor)	Service	Route	Frequency (Monday to Friday)	Frequency (Saturday)	First service	Last service
Church, Weybourne	Coasthopper	Kings Lynn - Hunstanton - Wells-next-to-Sea - Weybourne - Sheringham - Cromer	Hourly	Hourly	09:42	18:42
		Cromer - Sheringham - Weybourne - Wells-next-to-Sea - Hunstanton - Kings Lynn	Hourly	Hourly	09:26	17:26
High, Kelling, A148	5	North Walsham - Mundesley - Cromer - Holt	30 minutes	30 minutes	08:20	18:56
		Holt - Cromer - Mundesley - North Walsham	30 minutes	30 minutes	06:55	17:49
	19	Cromer - Weybourne - Holt	10:44 Monday, Wednesday and 10:27 Friday (Return 12:25 Monday, Wednesday and 12:43 Friday)			
	44	Holt - High Kelling - Sheringham	30 minutes	30 minutes	05:42	17:25
Sheringham - High Kelling - Holt		30 minutes	30 minutes	10:18	00:03	
The Street, Hempstead	16	Cromer - Baconsthorpe - Holt	Tuesday 10:38 (Return 12:25)			
	17	Holt - Baconsthorpe - Sheringham - West Runton	Tuesday 10:43 (Return 12:30)			
Green, Edgefield	43	Norwich - Reepham - Edgefield - Holt	Mon - Fri 06:48 (Return 18:38 and 19:05)			
Croft Lane, Saxthorpe	43	Norwich - Reepham - Edgefield - Holt	Mon - Fri 06:52 (Return 18:32 and 18:59)			
	45	Holt - Corpusty - Norwich	2 per day	2 per day	07:07	10:02
		Norwich - Corpusty - Holt	2 per day	2 per day	13:49	18:09
	45A	Norwich - Felthorpe - Reepham - Holt	Monday to Friday 17:26			
45B	Norwich - Felthorpe - Corpusty - Holt	Saturday 13:49 and 18:19				
Heydon Road Heydon Road	24	Fakenham - Reepham - Norwich	Tuesday 09:49 (Return 14:00)			
	43	Reepham - Aylsham - Norwich	6 per day	5 per day	10:12	18:36
		Norwich - Aylsham - Reepham	6 per day	6 per day	07:21	15:51
	45A	Norwich - Felthorpe - Holt	Monday to Friday 17:14			
	80	Aylsham - Reepham - Dereham	Friday 09:47 (Return 14:17)			
98	Cawston - Reepham - Fulmodeston - Fakenham	Thursday 09:17 (Return 13:48)				

Stop (if within 800 m of onshore cable corridor)	Service	Route	Frequency (Monday to Friday)	Frequency (Saturday)	First service	Last service
Hall Road, Alderford	24	Fakenham - Reepham - Norwich	Tuesday 10:04 (Return 13:46)			
Fakenham Road, Morton on the Hill	X29	Norwich - Foulsham - Fakenham	Hourly	Hourly	08:06	19:27
		Fakenham - Foulsham - Norwich	Hourly	Hourly	06:56	17:12
Des Amis, Easton	4	Swanton Morley - Dereham - Easton - Norwich	Hourly	Hourly	06:39	17:38
		Norwich - Easton - Dereham - Swanton Morley	Hourly	Hourly	07:44	18:46
Kings Head, Bawburgh	15	Shipdham - Hardingham - Norwich	Wednesday 09:10 (Return 13:05)			
	806	Bawburgh - Wymondham	Friday 09:20 (Return 12:10)			
Colney Lane, Hethersett	6	Norwich - Hethersett - Wymondham - Watton	Hourly	Hourly	08:29	19:22
		Watton - Wymondham - Hethersett - Norwich	Hourly	Hourly	07:12	17:49
	6A	Attleborough - Hethersett - Norwich	One Service (07:12)		-	-
		Norwich - Hethersett - Attleborough	Two Services Daily (16:57 and 19:22)			
	9A	Norwich - Cringleford - Hethersett	Monday to Friday 08:05 (Return 15:00/16:00)			
	14/15/15A	Thorpe St Andrew - Norwich - Hethersett - Wymondham	Every 15 minutes	Every 15 minutes	07:10	19:08
		Wymondham - Hethersett - Norwich - Thorpe St Andrew	Every 15 minutes	Every 15 minutes	06:34	19:14
	13A/13B/13C	Norwich - Hethersett - Attleborough	One morning and 4 evening services daily (07:41, 19:55, 20:55, 22:20, 23:08)			
		Attleborough - Hethersett - Norwich	6 services daily	5 services daily	16:42	22:46
	Short Lane, Main Road	10A	East Harling - Swardeston - Norwich	2 services Monday to Friday 07:53 and 10:20		
Norwich - Swardeston - East Harling			3 services Monday to Friday 13:31, 16:23 and 17:58			
37/38		Long Stratton - Mulbarton - Norwich	Half Hourly	Half Hourly	07:41	18:11
		Norwich - Mulbarton - Long Stratton	Half Hourly	Half Hourly	07:33	18:21
Hall, Dunston	1	Diss - Aslacton - Norwich	4 services per day (08:07, 10:01, 12:57 and 14:26)			
		Norwich - Aslacton - Diss	4 services per day (08:06, 10:01, 12:59 and 17:56)			
	2	Long Stratton - Norwich	Hourly	5 per day	07:28	21:10

Stop (if within 800 m of onshore cable corridor)	Service	Route	Frequency (Monday to Friday)	Frequency (Saturday)	First service	Last service
		Norwich - Long Stratton	Hourly	6 per day	10:13	22:44
	38	Norwich - Long Stratton	Half Hourly	Half Hourly	06:59	18:44
		Long Stratton - Norwich	Half Hourly	Half Hourly	06:56	19:19
	40	Diss - Harleston - Norwich	Saturday 08:30 (Return 15:05)			
	83	Norwich - Pulham - Harleston	4 per day		10:51	18:01
		Harleston - Pulham - Norwich	5 per day	4 per day	07:40	17:44

1.4.4.4 It can be seen from annex 7.8: Traffic and Transport Figures and Table 1.3 that there are some sections of the Hornsea Three onshore cable corridor where there are bus stops within 800 m, with services that may be convenient for construction workers. However, there are large lengths of the onshore cable corridor that would not be able to be accessible by public transport by construction workers.

1.4.5 Pedestrian routes

1.4.5.1 It is generally accepted that a reasonable distance that people would be prepared to walk to work is 2 km (IHT, Guidelines for Providing for Journeys on Foot, 2000). There are residential areas within 2 km of the Hornsea Three onshore cable corridor from which, if footpath provision is available, there is potential for construction workers to undertake their journey on foot.

1.4.6 Cycle routes

1.4.6.1 Cycle routes that cross or in the vicinity of the site are:

- Holt Explorer Loop: Routes from Regional Route 30 northeast crossing the Hornsea Three onshore cable corridor on the edge of Kelling Heath to Weybourne where it then routes south east through Bodham am West Becham and continues south and then west through Baconsthorpe. It then crosses the Hornsea Three onshore cable corridor as it routes west to Hempstead where it continues south west to Edgefield;
- Regional Route 30, located approximately 1 km west of the Hornsea Three onshore cable corridor routes, parallel to the onshore cable corridor from just south of Kelling Hall, through High Kelling and crosses the onshore cable corridor in the vicinity of the property 'Quietways' from where it routes east and connects with the Holt Explorer Loop;

- National Cycle Route 1, which is a long-distance cycle route connecting Dover and the Shetland Islands via the east coast of England and Scotland, routes to the west of the Hornsea Three onshore cable corridor. It routes through Reepham, approximately 1 km west of the onshore cable corridor, through Whitwell and Lenwade. After which it crosses the onshore cable corridor to the north of Attlebridge and continues southeast to Drayton.

1.4.6.2 It is generally accepted that a reasonable distance that people are willing to cycle to work is 5 km. There are a number of residential areas within 5 km of the Hornsea Three onshore cable corridor which have access to these cycle routes, enabling construction workers to cycle to work.

1.5 Description of construction work

1.5.1 Description of works and key parameters

1.5.1.1 The Hornsea Three onshore cable corridor comprises a corridor approximately 55 km in length between the cable landfall at Weybourne, onshore HVAC booster station at Little Barningham and the onshore HVDC converter/HVAC substation site near Swardeston to the south west of Norwich. Details of the project and construction methods are set out in volume 1, chapter 3: Project Description.

1.5.1.2 The Hornsea Three onshore cable corridor construction operations will include a main compound at Oulton Airfield, near Oulton Street and several secondary compounds for the storage of materials and equipment and to accommodate staff welfare facilities. This is described in section 1.6.2. At a number of locations specialist equipment will be required to undertake HDD operations. Details of the compound locations are provided in the Crossing Schedule (volume 4, annex 3.5: Crossing Schedule (Onshore)) which accompanies the DCO application.

1.5.1.3 Table 1.4 summarises the key parameters of the construction works.

Table 1.4: Maximum design scenario considered for the assessment of potential impacts on traffic and transport.

Potential impact	Maximum design scenario	Justification
Construction phase		
<p>The temporary impact of the construction work may affect driver delay.</p> <p>The temporary impact of the construction work may affect severance of routes.</p> <p>The temporary impact of the construction work may affect pedestrian delay.</p> <p>The temporary impact of the construction work may affect pedestrian amenity.</p> <p>The temporary impact of the construction work may affect highway capacity.</p> <p>The temporary impact of the construction work may affect accidents and road safety.</p> <p>The temporary impact of hazardous, dangerous and abnormal indivisible loads during construction works.</p>	<p><u>Hornsea Three landfall area</u></p> <p>The temporary construction compound has dimensions of 300 m by 200 m at the Hornsea Three landfall area.</p> <p>Thrust bore crossing method at Hornsea Three landfall area with pits measuring 5 m x 25 m x 6 m.</p> <p>A reasonable assumption is that 75% of staff assumed to drive themselves to work and no access by public transport (Additional 25% of staff assumed to car share).</p> <p>The worst case would involve the import and export of all material.</p> <p>The shortest practical duration of works would maximise daily HGV movements. A reasonable duration of 32 months has been assumed.</p>	<p>A well-known occurrence at construction sites is staff organising travel amongst themselves to car share, especially in rural locations. Furthermore, contractors regularly provide transport for their staff via minibus. The actual mode share of construction staff is not reported for any similar site, however, a calculation that 75% of construction staff drive is considered a reasonable assumption for assessment purposes</p> <p>The use of Thrust Bore, rather than an alternative TT, represents the highest number of vehicle movements due to the requirement to transport steel shuttering and additional craneage compared with other techniques such as HDD.</p> <p>Larger areas result in larger amounts of material and thus larger numbers of HGV movements.</p> <p>Fewer number of days to transport a given amount of material results in a larger number of daily HGV movements.</p>
<p>The temporary impact of the construction work may affect driver delay</p> <p>The temporary impact of the construction work may affect severance of routes.</p> <p>The temporary impact of the construction work may affect pedestrian delay.</p> <p>The temporary impact of the construction work may affect pedestrian amenity.</p> <p>The temporary impact of the construction work may affect highway capacity.</p> <p>The temporary impact of the construction work may affect accidents and road safety.</p> <p>The temporary impact of hazardous, dangerous and abnormal indivisible loads during construction works</p>	<p><u>Onshore cable corridor</u></p> <p>The route length is approximately 55 km.</p> <p>Duration of construction programme for the secondary compounds is 30 months (2.5 years) (secondary compounds, nor the storage areas, will not be in use for the full 30 month period).</p> <p>A reasonable assumption is that 75% of staff assumed to drive themselves to work and no access by public transport. (Additional 25% of staff assumed to car share).</p> <ul style="list-style-type: none"> • Widest cable trench option - six cable trenches up to 5 m width at surface (1.5 m at base) and 2 m depth Up to 1,650,000 m² (5 m x 55,000 m x 6) from installation of up to six cable trenches; • On average 0.6 m stabilised backfill in each 2 m deep trench; • Up to 99,000 m² from jointing bays (based on 440 jointing bays (each jointing bay is 9 m x 25 m)); • Up to 3,960 m² from link boxes (based on 440 link boxes (each link box: is 3 m x 3 m)). Link boxes are permanent sub surface structures; • Up to 396,000 m² from installation of temporary haul road/access tracks (6 m x 66,000 m per phase); • Up to 120 HDD locations per phase (up to 105 minor HDDs and 15 major HDDs per phase), including 15 HDD compounds; • Up to five secondary compounds (maximum area of construction compounds is 33,000 m². (average area 17,000 m²); and • Up to 55 storage areas. • 50% of the area of each compound would be surfaced with crushed aggregate. The aggregate would be removed when construction is complete. • The haul road would be surfaced with aggregate on geotextile and would be removed at the end of each construction phase. 	<p>A well-known occurrence at construction sites is staff organising travel amongst themselves to car share, especially in rural locations. Furthermore, contractors regularly provide transport for their staff via minibus. The actual mode share of construction staff is not reported for any similar site, however, a calculation that 75% of construction staff drive is considered a reasonable assumption for assessment purposes</p> <p>Maximising the depth and width of stabilised backfill/trenches would maximise HGV movements.</p> <p>Maximising the number of parallel trenches (minimum number of circuits per trench) would maximise HGV movements.</p> <p>The maximum design scenario in terms of traffic would be based on the minimum estimate of construction length.</p> <p>Larger areas/volumes result in larger amounts of material and thus larger numbers of HGV movements.</p> <p>Fewer number of days to transport a given amount of material results in a larger number of daily HGV movements.</p> <p>The maximum intensity of construction for the Hornsea Three onshore cable corridor would occur if it was built in a single phase within a 30 month (approximately 2.5 years) duration.</p>

Potential impact	Maximum design scenario	Justification
<p>The temporary impact of the construction work may affect driver delay.</p> <p>The temporary impact of the construction work may affect severance of routes.</p> <p>The temporary impact of the construction work may affect pedestrian delay.</p> <p>The temporary impact of the construction work may affect pedestrian amenity.</p> <p>The temporary impact of the construction work may affect highway capacity.</p> <p>The temporary impact of the construction work may affect accidents and road safety.</p> <p>The temporary impact of hazardous, dangerous and abnormal loads during construction works.</p>	<p><u>Onshore HVDC converter/HVAC substation</u></p> <p>Up to 149,302 m² for permanent area of site (including an area which may be used for landscaping) plus a temporary works area of 91,000 m².</p> <p>Maximum building dimensions: up to 220 m length, 75 m width and 25 m height for main buildings.</p> <p>The maximum intensity of construction for the onshore HVDC converter/HVAC substation would occur if it was built in a single phase with a three-year duration</p>	<p>A maximum area/volume of site cleared for works would maximise HGV movements.</p> <p>Larger areas/volumes result in larger amounts of material and thus larger numbers of HGV movements.</p> <p>The maximum design scenario in terms of traffic would be based on the minimum estimate of construction duration.</p> <p>Fewer number of days to transport a given amount of material results in a larger number of daily HGV movements.</p>
<p>The temporary impact of the construction work may affect driver delay.</p> <p>The temporary impact of the construction work may affect severance of routes.</p> <p>The temporary impact of the construction work may affect pedestrian delay.</p> <p>The temporary impact of the construction work may affect pedestrian amenity.</p> <p>The temporary impact of the construction work may affect highway capacity.</p> <p>The temporary impact of the construction work may affect accidents and road safety.</p> <p>The temporary impact of hazardous, dangerous and abnormal indivisible loads during construction works.</p>	<p><u>Onshore HVAC booster station</u></p> <p>Up to 30,407 m² for permanent area of site plus a temporary works area up to 25,000 m².</p> <p>Maximum building footprint of 9,000 m² (based on single building scenario (120 m length and 75 m width) and height up to 12.5 m).</p> <p>Up to 30,000 m³ excavated for basement (based on 5m deep and area of 6,000 m²).</p> <p>The maximum intensity of construction for the onshore HVAC booster station would occur if it was built in a single phase with a two-year duration</p> <p>All topsoil and subsoil generated from levelling and earthworks would be removed from the site.</p>	<p>A maximum area/volume of site cleared for works would maximise HGV movements.</p> <p>Larger areas/volumes result in larger amounts of material and thus larger numbers of HGV movements.</p> <p>The maximum design scenario in terms of traffic would be based on the minimum estimate of construction duration.</p> <p>Fewer number of days to transport a given amount of material results in a larger number of daily HGV movements.</p>

1.5.2 HGV routes

- 1.5.2.1 The Hornsea Three onshore cable corridor, proposed HGV access routes, access points, the locations of HDD sites and other features are shown at annex 7.8: Traffic and Transport Figures.
- 1.5.2.2 The Hornsea Three onshore cable corridor is divided into 21 sections, each with one or more construction access points. The HGV routes to the access points have been determined taking into account the suitability of the surrounding highway network including the existing accesses, the opportunities to provide access to sections of the onshore cable corridor along the haul road and the stated preferences of consultees, and in particular the Highway Authority.
- 1.5.2.3 Cable sections also relate to the physical features that act as barriers to movements of vehicles along the Hornsea Three onshore cable corridor. In general, such barriers are defined by the HDD crossing locations although in some cases, where a HDD crossing is required it is still possible to achieve vehicle movement along the cable crossing. For example, where a HDD crossing is required to place cables below a gas pipeline it may be possible for HGVs to pass over the gas pipeline with suitable load spreading ground reinforcement.

1.5.3 Access points

- 1.5.3.1 Figure 1.2 at annex 7.8: Traffic and Transport Figures identifies the locations of proposed HGV access points and routes used by HGVs.
- 1.5.3.2 Temporary Traffic Regulation Orders for a temporary 30 mph speed restriction will be progressed at every access where the speed limit is not already 30 mph so as to reduce vehicle speeds, which reduces the visibility requirement to 2.4 m x 43 m (Manual for Streets, Department for Transport and Communities and Local Government, 2007) which often rely upon roadside vegetation clearance. Details of such restrictions are established in the Outline CTMP (see document A8.2) and will form part of the CTMPs which will be agreed with the highway authority. The extent of each restriction will vary at each access based upon the existing speed limit, road alignment, road geometries and forward visibility.
- 1.5.3.3 The land required to provide the proposed access works is either highway or land available for temporary construction works within the DCO boundary. Using professional judgement, it is not expected that the use of any of the Hornsea Three onshore cable corridor access points will lead to any capacity constraints at these accesses owing to the low number of HGV movements at each access point during the peak network periods and therefore, capacity assessments have not been undertaken.
- 1.5.3.4 The access to the onshore HVDC converter/HVAC substation will be a permanent access from the B1113 and has been designed to accommodate HGVs and car movements on a daily basis (albeit such movements would not be daily when it is operational) and to accommodate Abnormal Indivisible Loads. Visibility splays of 2.4 m x 215 m are provided in lieu of the 60 mph speed limit.

- 1.5.3.5 The onshore HVAC booster station will be accessed using an existing industrial access with the B1149. In view of the rural location, and as discussed with NCC, traffic management measures will be adopted at this junction rather than undertake widening of the junction. The exact extent of these and all other traffic management measures at each access will be agreed with NCC at the time of preparing the subsequent CTMPs secured prior to the commencement of works and activities at the booster station.
- 1.5.3.6 The main compound at Oulton Street will be accessed from The Street, east of the B1149. Traffic management will be designed post submission as part of the subsequent CTMPs secured prior to the commencement of works and activities at the main compound, which might involve a diversion route.
- 1.5.3.7 In a number of cases the proposed access arrangements require HGVs to travel through or past sensitive areas. Measures to eliminate or minimise the adverse impact of these movements are described in section 1.7.
- 1.5.3.8 It is proposed to manage HGV movements so as to minimise impacts; for example, to avoid school start and finish times where the route passes close to a school and to avoid HGVs meeting on narrow sections of the road. Details are provided in Section 7.
- 1.5.3.9 Table 1.5 identifies the 21 cable sections, their lengths, accesses and the proposed HGV access routes.

Table 1.5: Cable Sections, Access Points and HGV Routes.

Cable Section	Description	Length (km)	Accesses	Local Access Route
1	Landfall to Holgate Hill	2.96	47 (B)	A148 - A1082 - A149
			45 (B)	A148 - A1082 - A149
			44 (B)	A148 - A1082 - A149
			ACC_P_75	A148 - Bridge Road- Holgate Hill
2	Holgate Hill to woodland north east of High Kelling	1.61	42C - Monitoring Access Only	A148 - Bridge Road- Holgate Hill
			41 (B)	A148 - Bridge Road
3	Woodland northeast of High Kelling to woodland south of Church Road	2.53	ACC_P_74	A148
			ACC_P_73	A148
			ACC_P_72	A148 - Selbrigg Road
			ACC_P_71	A148 - Selbrigg Road
			ACC_P_70	A148 - Selbrigg Road
			ACC_P_69	A148 - Selbrigg Road

Cable Section	Description	Length (km)	Accesses	Local Access Route
4	Woodland south of Church Road to woodland south and east of School Lane	2.47	ACC_P_68	A148 - Hempstead Road
			ACC_P_67	A148 - Hempstead Road
			39a(B)	B1149 - Hempstead Road - Hole Farm Road - School Lane
5	Woodland east of School Lane to Plumstead Road	1.92	ACC_P_66	B1149 - Hempstead Road - Hole Farm Road
			ACC_P_65	B1149 - Hempstead Road - Hole Farm Road
			ACC_P_64	B1149 - Plumstead Road
			ACC_P_63	B1149 - Plumstead Road
			ACC_P_62	B1149 - Sweetbriar Lane
			ACC_P_61	B1149 - Sweetbriar Lane
6	Plumstead Road to the B1149	2.3	37(E)	B1149 - Organic Waste Processing Site Access
			ACC_P_60	B1149
7	B1149 to land South of Town Close Lane	1.9	ACC_P_59	B1149
			ACC_P_58	B1149 - B1354
			ACC_P_57	B1149 - B1354
			36(C) - Monitoring Access Only	B1149 - B1354 - Croft Lane
			ACC_P_56	B1149 - B1354 - Town Close Lane
			35(C) - Monitoring Access Only	B1149 - B1354 - Town Close Lane
8	Land south of Town Close Lane to woodland north of Reepham Road	4.37	ACC_P_55	B1149 - Valley Road - Wood Dalling Road
			ACC_P_54	B1149 - Valley Road - Wood Dalling Road
			ACC_P_53	B1149 - Heydon Road - Heydon Road - Blackwater Lane
			ACC_P_52	B1149 - Heydon Road - Heydon Road - Blackwater Lane
			ACC_P_51	B1149 - Heydon Road - Heydon Road - Heydon Lane
			ACC_P_50	B1149 - Heydon Road - Heydon Road - Heydon Lane
			ACC_P_49	B1149 - Heydon Road
			ACC_P_48	B1149 - Heydon Road

Cable Section	Description	Length (km)	Accesses	Local Access Route
9	Land north of Reepham Road to woodland north of Reepham	1.95	ACC_P_47	B1149 - B1145 - Wood Dalling Road - Reepham Road
			ACC_P_46	B1149 - B1145 - Wood Dalling Road - Reepham Road
			34(A)	B1149 - B1145 - Wood Dalling Road - Reepham Road
			33(A)	B1149 - B1145 - Wood Dalling Road - Reepham Road
			ACC_P_45	B1149 - B1145 - Wood Dalling Road - Reepham Road
			ACC_P_44	B1149 - B1145 - Wood Dalling Road
			ACC_P_43	B1149 - B1145 - Wood Dalling Road
10	Woodland north of Reepham to woodland at Booton Common	1.74	ACC_P_42	B1149 - B1145
			32 (B)	B1149 - B1145
			ACC_P_41	B1149 - B1145
11	Woodland east of Reepham to The Grove	2.19	ACC_P_40	B1149 - Buxton Road - Church Road
			ACC_P_39	B1149 - Buxton Road - Church Road
			ACC_P_38	B1149 - Buxton Road - Church Road - Norwich Road - The Grove
			ACC_P_37	B1149 - Buxton Road - Church Road - Norwich Road - The Grove
12	The Grove to woodland south of Church Farm Lane	2.16	ACC_P_36	B1149 - Buxton Road - Church Road - Norwich Road
			ACC_P_35	B1149 - Buxton Road - Church Road - Norwich Road
			ACC_P_34	B1149 - Buxton Road - Church Road - Norwich Road - Church Road
			30(B)	B1149 - Buxton Road - Church Road - Norwich Road - Church Road
			29(B)	A1065 - A148 - B1149 - Buxton Road - Church Road - Norwich Road - Church Farm Lane

Cable Section	Description	Length (km)	Accesses	Local Access Route
13	Woodland south of Church Farm Lane to River Wensum	2.34	ACC_P_33	A1067 - Station Road - Reepham Road - Church Farm Lane
			ACC_P_32	A1067 - Station Road - Reepham Road - Hall Road
			28(C) - Monitoring Access Only	A1067 - Station Road - Reepham Road - Hall Road
			27(C) - Monitoring Access Only	A1067 - Station Road - Reepham Road
			26(B)	A1067 - Station Road - Reepham Road
			25 (B)	A1067 - Station Road
			ACC_P_31	A1067 - Station Road
14	River Wensum to woodland south west of Ringland	5.24	ACC_P_30 - Monitoring Access Only	A1067 - The Street
			24(A)	A1067 - The Street
			ACC_P_29	A1067 - Marl Hill
			ACC_P_28	A1067 - Marl Hill - Morton Lane
			ACC_P_27	A1067 - Marl Hill - Morton Lane
			ACC_P_26	A1067 - Marl Hill - Morton Lane - Ringland Lane
			23(A)	A1067 - Marl Hill - Morton Lane - Ringland Lane
			ACC_P_25	A1067 - Marl Hill - Morton Lane - Ringland Lane
			ACC_P_24	A1067 - Marl Hill - Morton Lane - Ringland Lane
			22(B)	A1067 - Marl Hill - Morton Lane - Ringland Lane
			ACC_P_23	A1067 - Marl Hill - Morton Lane - Ringland Lane - Weston Road
			ACC_P_22	A1067 - Marl Hill - Morton Lane - Ringland Lane - Weston Road
			21(B)	A1067 - Marl Hill - Morton Lane - Ringland Lane - Weston Road
20(B)	A1067 - Marl Hill - Morton Lane - Ringland Lane - Honingham Lane			
18(B)	A1067 - Marl Hill - Morton Lane - Ringland Lane - Honingham Lane			

Cable Section	Description	Length (km)	Accesses	Local Access Route
15	Woodland south west of Ringland to A47	2.1	17(B)	A47 - Taverham Road - Weston Road
			16(B)	A47 - Taverham Road - Weston Road
			ACC_P_21	A47 - Church Lane
16	A47 to Bawburgh Road	2.38	ACC_P_20	A47 - Dereham Road - Church Lane
			15(A)	A47 - Dereham Road - Church Lane
			ACC_P_19	A47 - Dereham Road - Church Lane - Broom Lane
			14(A)	A47 - Dereham Road - Marlingford Road
17	Bawburgh Road to woodland west of Little Melton	3.1	ACC_P_18	A47 - Dereham Road - Marlingford Road
			13(C)	A47 - B1108 - Stocks Hill - Marlingford Road - Bawburgh Road
			ACC_P_17	A47 - B1108 - Stocks Hill - Marlingford Road - Bawburgh Road
			ACC_P_16	A47 - B1108 - Stocks Hill - Marlingford Road - Bawburgh Road
			ACC_P_15	A47 - B1108 - Bawburgh Road
			ACC_P_14	A47 - B1108 - Bawburgh Road
			11(A)	A47 - B1108
ACC_P_13	A47 - B1108			

Cable Section	Description	Length (km)	Accesses	Local Access Route
18	Woodland west of Little Melton to A11	4.1	10(A)	B1172 - Colney Lane - Burnthouse Lane – Haul Road
			9(A)	B1172 - Colney Lane - Burnthouse Lane – Haul Road
			ACC_P_12	B1172 - Colney Lane - Burnthouse Lane – Haul Road
			ACC_P_11	B1172 - Colney Lane - Burnthouse Lane – Haul Road
			ACC_P_10	B1172 - Colney Lane - Burnthouse Lane - Little Melton Road
			ACC_P_9	B1172 - Colney Lane - Burnthouse Lane - Little Melton Road
			8(A)	B1172 - Colney Lane - Burnthouse Lane
			7(A)	B1172 - Colney Lane - Burnthouse Lane
			ACC_P_8	B1172 - Colney Lane - Burnthouse Lane
			6(B)	B1172 - Colney Lane - Burnthouse Lane
			50(B)	B1172 - Colney Lane
			5(A)	B1172
			4(C)	B1172
19	A11 to woodland north west of Swardeston	2.49	2(B)	A11 - Station Lane
			ACC_P_7	A11 - Station Lane - Cantley Lane
			ACC_P_6	A11 - Station Lane - Cantley Lane
			ACC_P_5	A11 - Station Lane - Cantley Lane – Haul Road
			ACC_P_4	A11 - Station Lane - Cantley Lane – Haul Road
20	Woodland north west of Swardeston to B1113	1.68	ACC_P_3	A47 - B1113 - Haul Road
			ACC_P_2	A47 - B1113 - Haul Road
			1(B)	A47 - B1113

Cable Section	Description	Length (km)	Accesses	Local Access Route
21	B1113 to end of Hornsea Three onshore cable corridor	1.89	ACC_P_1	A47 - B1113
			ACC_P_A	B1113 - Mangreen Lane
			ACC_P_B	B1113 - Mangreen Lane
			ACC_P_C	A140 - Mangreen
			ACC_P_D	A140 - Mangreen
			A(B)	A140 - Mangreen

1.5.4 Timescale for project

1.5.4.1 Full details of the construction programme are set out in volume 1, chapter 3: Project Description. In summary, onshore work is planned to commence in 2021 but could start as early as 2020. Hornsea Three could be built using a two-phase or a single-phase construction programme.

1.5.4.2 The single phase construction programme represents the maximum intensity of construction for Hornsea Three and would occur if all components (onshore HVAC booster station, onshore HVDC converter/HVAC substation, Hornsea Three onshore cable corridor and landfall works) were built simultaneously, or overlapping across multiple components. Onshore, this could result in a minimum duration of three years for all construction activities, although activities may be spatially distinct and would be preceded by pre-construction activities such as borehole investigations at HDD crossing points.

1.5.4.3 Under a two-phase programme scenario, there would be a three year gap between phases and the total duration of the onshore cable corridor construction, including this three year gap, would be eight years. This is as a result of staggered construction of the components (onshore HVAC booster station, onshore HVDC converter/HVAC substation and Hornsea Three onshore cable corridor) and each phase would be preceded by pre-construction activities such as borehole investigations at HDD crossing points.

1.5.4.4 The shorter timescale would give rise to the highest daily traffic flows. The level of construction vehicle trip generation over this period will vary with intermittent periods of higher activity associated particularly with the installation of the Hornsea Three onshore cable corridor haul road.

1.5.4.5 The construction of the onshore HVDC converter/HVAC substation is expected to be over a period of 3 years. The construction of the onshore HVAC booster station is expected to be over a period of 2 years. The Hornsea Three onshore cable corridor and the onshore HVDC converter/HVAC substation and HVAC booster station are expected to be constructed simultaneously.

- 1.5.4.6 The cable will be laid in sections with up to five teams working at any one time on separate work fronts. On the basis that this assessment has separated the cable corridor into 21 cable sections this means that, for assessment purposes, approximately one quarter of the Hornsea Three onshore cable corridor will be under construction at any one time. This is considered an over estimate; however, it represents a robust analysis.
- 1.5.4.7 It is also expected that work on HDD crossings will occur before the work on the main trenches on each cable section. However, in order to undertake a robust assessment, the calculation of the vehicle trip generation assumes that work on the Hornsea Three onshore cable corridor and work on the HDD crossings occur at the same time (but still only on five sections at any one time).

1.6 Transport impact of construction

1.6.1 Assumptions for deriving vehicle movements

- 1.6.1.1 This TA assesses the transport impact of the construction phase of Hornsea Three.
- 1.6.1.2 During the operational phase, the only vehicle movements generated will be maintenance visits, which will be typically one vehicle on an approximate weekly basis. These visits are likely to be made by light vehicles only and would use the existing road network and the permanent onshore HVAC booster station and HVDC converter/HVAC substation accesses constructed as part of Hornsea Three. One vehicle arrival per week is very low and infrequent and will not result in any highway capacity issues and an assessment of this is scoped out.
- 1.6.1.3 Vehicle movements generated during the decommissioning phase will be lower than those during the construction phase since the removal of materials does not need to be delicately transported and can be bulk loaded whilst some infrastructure will be retained in-situ. Given that some infrastructure will be left in-situ, this results in less transport requirement which results in fewer vehicle movements in comparison to the construction phase. All mitigation measures that are identified for the construction phase will also be adopted during the decommissioning phase, thus, for a maximum design scenario, it can be determined that the identification of impacts resulting from traffic generated during the construction phase, would also apply to the decommissioning phase. An assessment of the decommissioning phase specifically is therefore scoped out.
- 1.6.1.4 A number of assumptions relating to the construction methodology to enable a maximum design scenario to be established have been adopted through discussion with the engineers responsible for the project to derive the number of vehicle movements associated with the construction works. These are set out at annex 7.6: Construction Vehicle Trip Generation Assumptions.

1.6.2 Vehicle trip generation, distribution and assignment (construction)

- 1.6.2.1 Detailed assessments of vehicle generation have been carried out for the construction phase of development. The level of vehicle generation during the operational and decommissioning phases would be significantly lower than during the construction phase.
- 1.6.2.2 During the operational phase, the only vehicle movements generated will be maintenance visits, which will be typically one vehicle on an approximate weekly basis. These visits are likely to be made by light vehicles only and would use the existing road network and the permanent HVAC booster station and HVDC converter/HVAC substation accesses constructed as part of Hornsea Three. One vehicle arrival per week is very low and infrequent and will not result in any highway capacity issues and an assessment of this is scoped out.

- 1.6.2.3 Vehicle movements generated during the decommissioning phase will be lower than those during the construction phase since the removal of materials does not need to be delicately transported and can be bulk loaded whilst some infrastructure will be retained in-situ. Given that some infrastructure will be left in-situ, this results in less transport requirement which results in fewer vehicle movements in comparison to the construction phase. All mitigation measures that are identified for the construction phase will also be adopted during the decommissioning phase, thus, for a maximum design scenario, it can be determined that the identification of impacts resulting from traffic generated during the construction phase, would also apply to the decommissioning phase. An assessment of the decommissioning phase specifically is therefore scoped out.
- 1.6.2.4 The level of vehicular trip generation associated with the construction phase of Hornsea Three is based on the assumptions set out in Table 1.4. Details of the technical parameters used for the construction stage trip generation calculations are presented in annex 7.6: Construction Vehicle Trip Generation Assumptions.
- 1.6.2.5 For the purposes of estimating the construction traffic generation, the Hornsea Three onshore cable corridor is divided into 21 sections using professional judgement based upon groupings of access routes that share key sections of the highway network, as shown at annex 7.8: Traffic and Transport Figures. There will be up to five work fronts (i.e. up to five construction activities – see volume 1, chapter 3: Project Description) being undertaken at any one time. It is assumed that there would be one work front on each cable section. This means that up to five cable sections could be under construction at any one time.
- 1.6.2.6 A worst case scenario would be created when five adjacent cable sections (or near to one-another) are constructed at the same time because this would concentrate the construction vehicle movements onto the same road links, especially those near to the cable sections under construction. If five cable sections that were spread apart from each other were constructed at the same time, then this would spread the construction vehicles across all of the road links within the study area and thus result in fewer construction vehicle movements on each road link in comparison to the above.
- 1.6.2.7 Based on this, if five adjacent or nearby cable sections in the northern part of the Hornsea Three onshore cable corridor were assessed, then the construction traffic flows would be concentrated in the northern part of the study area. If five adjacent or nearby cable sections in the southern part of the Hornsea Three onshore cable corridor were assessed, then the construction traffic flows would be concentrated in the southern part of the study area.
- 1.6.2.8 Therefore, a range of scenarios have been created that concentrates the construction traffic flows at differing parts of the study area, as follows:
- Northern part of corridor: cable sections 1, 2, 3, 4 and 5 all under construction simultaneously;
 - Middle (northern) part of corridor: cable sections 6, 8, 9, 10 and 11 all under construction simultaneously;
 - Middle (southern) part of corridor: cable sections 12, 13, 14, 15 and 16 all under construction simultaneously; and

- Southern part of corridor: cable sections 17, 18, 19, 20 and 21 all under construction simultaneously.
- 1.6.2.9 The exact groupings of cable sections do not make any noticeable difference to the assessment. The important factor is that cable sections that are adjacent or near to one-another are grouped together.
- 1.6.2.10 Each of these four scenarios creates different traffic flows on each road link and junction within the study area.
- 1.6.2.11 Each of these four scenarios creates different traffic flows on each road link and junction within the study area. Therefore, to ensure a robust analysis, the maximum construction traffic flow for the four scenarios on each link and junction has been assumed as the peak construction traffic flows and has been assessed.
- 1.6.2.12 In terms of a network, this overestimates the total number of construction vehicles, however, in terms of individual links and junctions, it represents the peak construction traffic flow that could be generated along or through them and is thus a robust methodology.
- 1.6.2.13 Each of the 21 Hornsea Three onshore cable corridor sections has one or more construction access points. Based on the daily HGV movements generated by each cable section and the number of access points on each location, it is assumed for assessment purposes that the number of HGV movements across each cable section will be averaged across the number of access points for each onshore cable corridor. This is detailed at Appendix A.
- 1.6.2.14 The HGV routes to the access points have been determined taking into account the suitability of the surrounding highway network including the existing accesses, the opportunities to provide access to sections of the Hornsea Three onshore cable corridor along the haul road and the stated preferences of consultees, and in particular the Highway Authority.
- 1.6.2.15 Cable sections also relate to the physical features that act as barriers to movements of vehicles along the Hornsea Three onshore cable corridor. In general, such barriers are defined by the HDD crossing locations although in some cases, where a HDD crossing is required it is still possible to achieve vehicle movement along the cable crossing. For example, where a HDD crossing is required to place cables below a gas pipeline it may be possible for HGVs to pass over the gas pipeline with suitable load spreading ground reinforcement.
- 1.6.2.16 Table 1.5 identifies the 21 Hornsea Three onshore cable corridor sections, their lengths and the proposed HGV access routes.
- 1.6.2.17 In terms of the wider distribution of HGVs, this is wholly dependent upon the procurement of materials at the time of construction. Therefore, assumptions have been made which seek to make reasonable estimates, but which also seek to incorporate a level of robustness.
- 1.6.2.18 From a high level perspective, the A11 and the A47 (west) offer the key strategic routes to/from the largest catchment areas and it is likely that the majority of HGV movements would be via these two roads. Other key roads from outside the study area are the A148 (west), the A47 (east), the A146 and the A140.
- 1.6.2.19 An estimated distribution of HGVs has concentrated movement along the A11 and the A47 (west) as follows:
- A11 – 35%;
 - A47 (west) – 35%;
 - A148 (west) – 10%;
 - A47 (east) – 5%;
 - A146 – 5%; and
 - A140 – 10%.
- 1.6.2.20 There is potential for materials to originate from very localised areas within the study area. The above assumes all material originates from outside the study area. Such an assumption means that all HGVs travel through the maximum number of links within the study area and thus represents the maximum design scenario.
- 1.6.2.21 If local trips were assumed, then HGVs would not all be assigned onto the wider parts of the network and thus may underestimate the number of HGV movements on both the trunk road network and parts of the local road network within the study area.
- 1.6.2.22 If local trips were assumed then there may also be some different turning movements at some junctions, however, these would balance out against different turning movements at other junctions.
- 1.6.2.23 It is recognised that the above is estimated using professional judgement based upon a high level review of the highway network and the study area in advance of any procurement of materials etc. It is also recognised that there will likely be day-to-day variances in the movement of material throughout the programme based on the procurements in place and the resultant origins of materials. For example, an amount of material is sourced from one location, but when this amount is reached, material is then sourced from another location. This will change the movement of HGVs as the construction phase progresses and result in day-to-day variances.
- 1.6.2.24 To ensure this assessment accounts for these day-to-day variances, a methodology has been adopted that increases the proportion of trips from each origin.
- 1.6.2.25 For assessment purposes only, it has been assumed that approximately double the proportion of HGVs would originate from the above six links and thus allows for day-to-day variances along them. This effectively doubles the total number of HGVs generated by the proposals when all road links are considered together as it effectively approximately doubles the number of HGVs on each link and through each junction. Although this would not happen in practice (because an increase from one origin would be offset by a decrease from another origin), it allows for a robust assessment that allows for day-to-day variances when individual links and junctions are considered.
- 1.6.2.26 The assessments do consider each road link and each junction separately and therefore the assessment methodology adopted allows for day-to-day variances to be considered and the upper of that variance to be assessed.

- 1.6.2.27 The assessment distribution of HGVs is therefore as follows:
- A11 – 50%;
 - A47 (west) – 50%;
 - A148 (west) – 25%;
 - A47 (east) – 25%;
 - A146 – 25%;
 - A140 – 25%; and
 - Total – 200%.
- 1.6.2.28 As above, a distribution of 200 % would not occur in practice, however, they allow for day-to-day variances and a robust assessment of the impact of construction vehicles and therefore form the basis of all assessments.
- 1.6.2.29 Data from the 2011 Census has been utilised to estimate the potential origin of construction staff using location of usual residence and place of work for the Broadland, North Norfolk and South Norfolk areas.
- 1.6.2.30 The onshore cable corridor extends through the Broadland, North Norfolk and South Norfolk datasets. Resident locations for the cumulative daytime populations of these datasets have been identified and aggregated to establish potential origins of construction staff.
- 1.6.2.31 In a similar manner to the HGV distribution, resident locations from within Norwich were excluded from this analysis. This distributes staff origins from outside of the study area and thus maximises the number of links within the study area that have staff movements generated along them. This is because it forces all staff to arrive from outside the study area which maximises the number of road links they travel on within the study area. If staff were to originate from within the study area then those staff would not travel on road links between their origin and the outer edge of the study area.
- 1.6.2.32 This has resulted in the following construction staff distribution:
- A11 – 50%;
 - A148 (west) – 8%;
 - A47 (east) – 28%;
 - A146 – 11%;
 - A47 (west) – 7%;
 - A1065 – 6%;
 - A11 – 16%;
 - A140 – 13%; and
 - A140 corridor between Comer and Norwich – 12%.
- 1.6.2.33 The above construction staff distribution results in a relatively equal spread of movement and appears to be representative of the local tourism accommodation in the surrounding areas and also the built-up areas in the surrounding area, which provides confidence that the assumptions are suitable for assessment purposes. This view has been identified by identifying the surrounding built up areas and large tourist accommodation areas on maps and forming a judgement.
- 1.6.2.34 Details of the assignment of the construction traffic onto the highway network are provided at Appendix A.
- 1.6.2.35 The above assumes that all material and construction staff travel directly to/from the cable accesses. In reality some vehicles would do so, but some would instead travel to/from one of the secondary construction compounds, which are also from the same accesses to the compounds and storage areas located along the onshore cable corridor.
- 1.6.2.36 However, this assumption does not incorporate an estimate for vehicle movements to/from the main compound at Oulton Street.
- 1.6.2.37 Following the experiences at Hornsea Project One, it has been identified that a main compound is needed as part of the construction process to manage the construction activities and to act as a central base for the construction operations to ensure they progress efficiently. The main compound will be used for storage of some materials, for example cable drums, and will be the key base for management to co-ordinate the operations. The location for a main compound at Oulton Street has been identified.
- 1.6.2.38 To estimate a number of construction vehicle movements, the results of the above trip generation, distribution and assignment exercise has been utilised. The above results in daily construction vehicle movements being assigned onto each link.
- 1.6.2.39 These were then reviewed and those on the B1149 near Oulton were disaggregated to remove all traffic associated with landfill, the onshore HVDC converter/HVAC substation and the HVAC booster station, since these all have their own separate compounds. HGVs associated with concrete pouring at link boxes and aggregate for the haul road and secondary compounds will all deliver direct to their respective locations and so these were also removed. The remaining construction vehicle movements are those that could travel to and from the main compound at Oulton Street.
- 1.6.2.40 This is of course theoretical and it is recognised that not all staff and not all HGVs would travel to the main compound. However, this is considered a reasonable methodology to estimate the number of movements based on the peak movement at any one time.
- 1.6.3 Vehicle trip movements (construction)**
- 1.6.3.1 The daily construction vehicle movements by cable section have been assigned onto the network in accordance with the above and are set out in Table 1.6.1

¹ Table shows all links for which traffic data is available within the initial study area. Some of these links do not have any construction traffic flows generated along them and these links are retained within the table to illustrate this

1.6.3.2 Using the assumptions above to estimate the potential number of vehicle movements at the main compound at Oulton Street, this equates to a peak of 130 daily staff vehicle movements) and a peak of 118 daily HGV movements).

Table 1.6: Daily construction vehicle movements.

Link	Construction Staff	HGVs	Total Vehicle Movements
Link ID 35: A148, west of The Street and east of Green Lane	139	377	517
Link ID 34: A148 west of Holt and east of Letheringsett	139	377	517
Link ID 36: A148, east of the B1149 roundabout and west of Station Road	84	297	380
Link ID 50: B1354 between the Swanton Road junction and B1110 junctions	0	0	0
Link ID 55: B1354 east of Melton Constable and west of Briston	0	0	0
Link ID 59: B1149 at Edgefield, north of the village hall and south of Hempstead Road	137	373	511
Link ID 37: A148 at High Kelling, south of Kelling Hospital	84	297	380
Link ID 41: A148, east of Bodham and west of the Woodlands Leisure centre	244	439	684
Link ID 43: A148, west of the B1436 junction and east of the Lion's Mouth junction	322	495	817
Link ID 190: B1436, east of Felbrigg	322	495	817
Link ID 49: A140, south of Roughton and north of the Topshill Road junction	322	495	817
Link ID 1: A149 west of Weybourne and east of The Pheasant Hotel	0	0	0
Link ID 2: A149 east of Weybourne, west of the North Norfolk Railway Line	133	221	354
Link ID 81: A1067, north of Bridge Road and east of Little Ryburgh	71	214	285
Link ID 84: B1145 at Bawdeswell, between The Street junction and Hall Road junction	0	0	0
Link ID 86: B1145, west of Reepham and east of the Old Lane junction	0	0	0
Link ID 90: B1145 east of Cawston, west of the B1149 crossroads	243	379	622
Link ID 78: B1145 east of the B1149 crossroads junction, west of Cawston Park Hospital	81	0	81

Link	Construction Staff	HGVs	Total Vehicle Movements
Link ID 118: A140, south of Aylsham's B1145 / A140 roundabout, and north of Marsham	283	495	777
Link ID 111: A1067, between Attlebridge and the Fir Covert Road junction	275	356	631
Link ID 145: A140 between the A47 and B1113 junctions	317	528	845
Link ID 146: B1113, south of the A47 near Norwich Sports ground	317	528	845
Link ID 129: A47 at Honingham	161	412	573
Link ID 157: A47 at Bawburgh	175	412	587
Link ID 147: A47 at Intwood	418	552	970
Link ID 153: A11 at Hethersett	128	283	411

1.6.3.3 An assessment of the percentage impact of vehicle movements on specific links is provided in the following section.

1.6.4 Percentage impact of construction traffic on highway links

1.6.4.1 The predicted level of construction traffic is expressed as a percentage change in daily flows on the links in Table 1.7. Observed flows have been factored using local growth predictions to 2022.

Table 1.7: Percentage impact of construction traffic – sensitivity testing.

Highway Link	Daily Vehicle Movements					
	2022 Base		Maximum Construction		Percentage Increase	
	Total	HGVs	Total	HGVs	Total	HGVs
Link ID 35: A148, west of The Street and east of Green Lane	13908	838	517	377	3.7%	45%
Link ID 34: A148 west of Holt and east of Letheringsett	11466	691	517	377	4.5%	55%
Link ID 36: A148, east of the B1149 roundabout and west of Station Road	12242	612	380	297	3.1%	48%
Link ID 50: B1354 between the Swanton Road junction and B1110 junctions	4037	292	0	0	0.0%	0%
Link ID 55: B1354 east of Melton Constable and west of Briston	5598	405	0	0	0.0%	0%
Link ID 59: B1149 at Edgefield, north of the village hall and south of Hempstead Road	4537	173	511	373	11.3%	216%
Link ID 37: A148 at High Kelling, south of Kelling Hospital	13893	694	380	297	2.7%	43%
Link ID 41: A148, east of Bodham and west of the Woodlands Leisure centre	13237	712	684	439	5.2%	62%
Link ID 43: A148, west of the B1436 junction and east of the Lion's Mouth junction	14346	645	817	495	5.7%	77%
Link ID 190: B1436, east of Felbrigg	9665	488	817	495	8.5%	101%
Link ID 49: A140, south of Roughton and north of the Topshill Road junction	12041	593	817	495	6.8%	83%
Link ID 1: A149 west of Weybourne and east of The Pheasant Hotel	3567	24	0	0	0.0%	0%
Link ID 2: A149 east of Weybourne, west of the North Norfolk Railway Line	4771	33	354	221	7.4%	675%
Link ID 81: A1067, north of Bridge Road and east of Little Ryburgh	9451	543	285	214	3.0%	39%
Link ID 84: B1145 at Bawdeswell, between The Street junction and Hall Road junction	3390	128	0	0	0.0%	0%
Link ID 86: B1145, west of Reepham and east of the Old Lane junction	2980	113	0	0	0.0%	0%
Link ID 90: B1145 east of Cawston, west of the B1149 crossroads	3477	127	622	379	17.9%	298%
Link ID 78: B1145 east of the B1149 crossroads junction, west of Cawston Park Hospital	4834	163	81	0	1.7%	0%
Link ID 118: A140, south of Aylsham's B1145 / A140 roundabout, and north of Marsham	15732	750	777	495	4.9%	66%
Link ID 111: A1067, between Attlebridge and the Fir Covert Road junction	8995	626	631	356	7.0%	57%
Link ID 145: A140 between the A47 and B1113 junctions	24868	1314	845	528	3.4%	40%
Link ID 146: B1113, south of the A47 near Norwich Sports ground	8848	301	845	528	9.6%	175%
Link ID 129: A47 at Honingham	29944	2928	573	412	1.9%	14%
Link ID 157: A47 at Bawburgh	48143	3435	587	412	1.2%	12%
Link ID 147: A47 at Intwood	58002	4520	970	552	1.7%	12%
Link ID 153: A11 at Hethersett	53652	4522	411	283	0.8%	6%
Link ID 144: A47, between A140 and A146 junctions	55089	3157	803	392	1.5%	12%
Link ID 197: A1065, North of Swaffham	8336	530	353	259	4.2%	49%

Highway Link	Daily Vehicle Movements					
	2022 Base		Maximum Construction		Percentage Increase	
	Total	HGVs	Total	HGVs	Total	HGVs
Link ID 195: A1065, east of Weasenham	5580	485	353	259	6.3%	77%
Link ID 5: A1082, South of Sheringham	8788	119	354	221	4.0%	185%
Link ID 200: A1270 Northern Distributor Road between A1067 and B1149 junction	21467	1368	671	356	3.1%	26%
Link ID 114: B1149 between A1270 Northern Distributor Road and Buxton Road junctions	11400	594	978	562	8.6%	95%
Link ID 201: A1270 Northern Distributor Road between B1149 and A140 junctions	25000	1593	1070	622	4.3%	39%
Link ID 204: A1270 Northern Distributor Road between A140 and A47 junctions	22933	1461	1093	629	4.8%	43%
Link ID 118: A140 between A1270 and B1145	14967	484	777	495	5.2%	102%
Link ID 204: A1270 between A140 and A47 (Near junction with A47)	35367	2254	1093	629	3.1%	28%
Link ID 137: A47 East of A1270 junction	45233	2882	664	263	1.5%	9%
Note: Worst case during all phases of construction shown						

- 1.6.4.2 In relation to changes in traffic flows, an assessment has been undertaken based on current relevant guidance for assessing the environmental effects of traffic. This is set out within The Institute of Environmental Assessment (now the Institute of Environmental Management and Assessment (IEMA)) publication 'Guidance Note Number 1: Guidelines on the Environmental Assessment of Road Traffic', 1993.
- 1.6.4.3 The IEMA guidance notes in paragraph 3.16 that "*daily variation of traffic on a road is frequently at least some + or -10%*" and in paragraph 3.20 that "*normally it would not be appropriate to consider links where the traffic flows have changed by less than 10% unless there are significant changes in the composition of traffic*".
- 1.6.4.4 It is concluded that, in terms of total traffic flows, the impact vehicles generated as a result of the construction of the Hornsea Three onshore cable corridor would not lead to a significant increase in traffic flows, as the increase is typically less than 10%, and therefore less than typical daily variation.
- 1.6.4.5 The exceptions to this are the following:
- B1149 at Edgefield, north of the village hall and south of Hempstead Road (11.3%); and
 - B1145 east of Cawston, west of the B1149 crossroads (17.9%).
- 1.6.4.6 The base 2022 daily traffic flow on these two roads are 4,537 and 3,477 two-way vehicle movements respectively, increasing to 5,048 and 4,099 two-way vehicle movements respectively following the addition of the peak construction traffic flows.
- 1.6.4.7 Guidance on the capacity of single carriageway roads is set out in TA46/96 Traffic Flow Ranges for the Use in New Rural Road, contained at Volume 5, Section 1, Part 3 of the Design Manual for Roads and Bridges, published by HE (then the Highways Agency) *et al*.
- 1.6.4.8 Although this document relates to new roads on the Trunk Road Network, it does give a useful guide at its Table 2.1, where it sets out the opening year economic Annual Average Daily Traffic (AADT) flow range of a single carriageway road as being up to 13,000.
- 1.6.4.9 Even taking account of these allowances, this range is more than double the flow that is predicted on these two links following the addition of the peak construction traffic flows. On this basis, it is considered that, despite the percentage changes in traffic flows on these two links, the peak construction traffic flows would not result in any link flow capacity issues.
- 1.6.4.10 These ranges cannot be applied to every road, however, given the difference in flow between the range and the predicted flows on these two links, robust conclusions can be drawn in relation to these two links.
- 1.6.4.11 In relation to the Trunk Road Network, the maximum increase is predicted to be only 1.9%, on the A47 at Honington. The increase on the A11 is predicted to be only 0.8%. Such increases are negligible and well within generally accepted day-to-day variances in traffic flows.
- 1.6.4.12 It should also be noted that the levels of increase identified above would occur over relatively short periods, with the main works on each section of the Hornsea Three onshore cable corridor been estimated based on the shortest time possible to maximise vehicle movements and lasting a matter of months.
- 1.6.4.13 Table 1.8 sets out the impact of construction traffic flows on the peak hourly basis against the base flows of the 2022 assessment year. This occurs between 07:00 and 08:00 (the AM construction peak) when staff arrive and between 18:00 and 19:00 (the PM construction peak) when staff depart.

Table 1.8: AM and PM construction peak impacts.

Highway Link	2022 Base		Construction Staff		Percentage Increase	
	AM Construction Peak	PM Construction Peak	AM Construction Peak	PM Construction Peak	AM Construction Peak	PM Construction Peak
A148, west of The Street and east of Green Lane	738	715	70	70	9.44%	9.75%
A148 west of Holt and east of Letheringsett	573	566	70	70	12.17%	12.31%
A148, east of the B1149 roundabout and west of Station Road	698	594	42	42	5.98%	7.04%
B1354 between the Swanton Road junction and B1110 junctions	282	231	0	0	0.00%	0.00%
B1354 east of Melton Constable and west of Briston	423	347	0	0	0.00%	0.00%
B1149 at Edgefield, north of the village hall and south of Hempstead Road	311	251	69	69	22.10%	27.40%
A148 at High Kelling, south of Kelling Hospital	723	722	42	42	5.78%	5.79%
A148, east of Bodham and west of the Woodlands Leisure centre	688	699	122	122	17.74%	17.46%
A148, west of the B1436 junction and east of the Lion's Mouth junction	767	733	161	161	21.01%	21.99%
Link ID 190: B1436, east of Felbrigg	550	502	161	161	29.30%	32.10%
A140, south of Roughton and north of the Topshill Road junction	742	729	161	161	21.72%	22.13%
A149 west of Weybourne and east of The Pheasant Hotel	92	145	0	0	0.00%	0.00%
A149 east of Weybourne, west of the North Norfolk Railway Line	129	216	67	67	51.68%	30.81%
A1067, north of Bridge Road and east of Little Ryburgh	705	560	36	36	5.06%	6.37%
B1145 at Bawdeswell, between The Street junction and Hall Road junction	225	227	0	0	0.00%	0.00%
B1145, west of Reepham and east of the Old Lane junction	219	187	0	0	0.00%	0.00%
B1145 east of Cawston, west of the B1149 crossroads	299	283	122	122	40.59%	42.98%
B1145 east of the B1149 crossroads junction, west of Cawston Park Hospital	389	304	41	41	10.47%	13.39%
A140, south of Aylsham's B1145/A140 roundabout, and north of Marsham	1132	1001	141	141	12.49%	14.13%
A1067, between Attlebridge and the Fir Covert Road junction	906	670	138	138	15.19%	20.52%

Highway Link	2022 Base		Construction Staff		Percentage Increase	
	AM Construction Peak	PM Construction Peak	AM Construction Peak	PM Construction Peak	AM Construction Peak	PM Construction Peak
A140 between the A47 and B1113 junctions	1867	1701	159	159	8.50%	9.33%
B1113, south of the A47 near Norwich Sports ground	797	670	159	159	19.91%	23.70%
A47 at Honingham (HE)	2511	1905	80	80	3.20%	4.22%
A47 at Bawburgh (HE)	4457	3257	88	88	1.97%	2.69%
A47 at Intwood (HE)	5022	4066	209	209	4.16%	5.13%
A11 at Hethersett (HE)	4797	3458	64	64	1.33%	1.85%
A47, between A140 and A146 junctions	4770	3862	206	206	4.32%	5.33%
Link ID 197: A1065, North of Swaffham	442	428	47	47	10.64%	10.98%
Link ID 195: A1065, east of Weasenham	296	287	47	47	15.89%	16.41%
Link ID 5: A1082, South of Sheringham	500	457	67	67	13.29%	14.57%
Link ID 200: A1270 Northern Distributor Road between A1067 and B1149 junction	1859	1505	108	108	5.81%	7.17%
Link ID 114: B1149 between A1270 Northern Distributor Road and Buxton Road junctions	780	630	208	208	26.64%	33.02%
Link ID 201: A1270 Northern Distributor Road between B1149 and A140 junctions	2164	1753	224	224	10.35%	12.78%
Link ID 204: A1270 Northern Distributor Road between A140 and A47 junctions	1986	1608	232	232	11.70%	14.45%
Link ID 118: A140 between A1270 and B1145	1296	1049	141	141	10.91%	13.48%
Link ID 204: A1270 between A140 and A47 (Near junction with A47)	3062	2480	232	232	7.59%	9.37%
Link ID 137: A47 East of A1270 junction	3916	3171	201	201	5.12%	6.33%

Note: Worst case during all phases of construction shown

1.6.4.14 It is concluded from the above that the absolute level of increase in vehicle numbers resulting from construction activities will not lead to any significant increase in total link flows within the Hornsea Three traffic and transport study area. The levels of increase identified are within typical daily variations in traffic flows. Where there are large percentage increases, this is due to low baseline traffic flows which do not result in highway capacity issues and would not with the addition of Hornsea Three.

1.6.5 Turning movements through junctions

1.6.5.1 Previous consultation with HE and NCC identified the following junction where there are current capacity concerns:

- B1172/A140 signalised junction south of Norwich.

1.6.5.2 Operational assessments have therefore been undertaken to assess the capacity of this junction and the impact of construction vehicles upon its operation. These assessments have been undertaken using the LINSIG computer modelling software, which is the industry standard DfT approved modelling package for assessing the operation of signalised junctions.

1.6.5.3 The requirement to assess any other junction is based upon an analysis of the change in traffic flow through it. When construction traffic flows are added to the AM and PM construction peak hours, if the subsequent traffic flows through the junction exceed the network AM and PM peak hour flows, then an operational assessment will be undertaken as part of the Transport Assessment and as set out at Appendix C.

1.6.5.4 For the Trunk Road Network, if there are increases of more than 30 vehicle movements per hour during the network AM and PM peak hours, then an operational assessment would be undertaken.

1.6.5.5 An analysis of turning movements through junctions is attached at Appendix C.

1.6.5.6 This analysis has identified two additional junctions within the traffic flow model which have several arms of which the addition of construction traffic between 07:00 – 08:00 and 18:00 – 19:00 results in traffic flows increasing above the network peaks (07:45 to 08:45 and 16:30 to 17:30). These comprise the following:

- A148/B1149/B1110 four-arm roundabout at Holt; and
- B1149/B1145 four-arm roundabout east of Cawston.

1.6.5.7 These assessments have been undertaken using the Junctions9 computer modelling software, which is the industry standard DfT approved modelling package for assessing the operation of priority controlled junctions.

1.6.6 Operational assessment of A140/B1113 signalised junction

1.6.6.1 At the request of NCC, an operational assessment has been undertaken of the A140/B1113 signalised junction using the LINSIG computer modelling software during the observed network AM and PM peak hours. The signal timing specification has been obtained to calibrate the model against and is attached at Appendix D, which also contains the base survey data and queue length surveys used for calibration. Table 1.9 summarises the results for 2017 observed traffic flows, 2022 without and with construction traffic and full output files are attached at Appendix E.

Table 1.9: Results of operational assessment of A140/B1113 signalised junction.

Results of operational assessment of A140/B1113 signalised junction						
AM Peak Hour						
	2017 Observed		2022 Baseline		2022 Baseline plus Construction	
	DoS	MMQ	DoS	MMQ	DoS	MMQ
A140 Ipswich Road (North) – Southbound nearside lane – Ahead only	92.4%	13.8	100.3%	24.9	100.3%	24.9
A140 Ipswich Road (North) – Southbound offside lane – Right turn only	90.4%	5.7	98.0%	8.2	114.5%	64.2
A140 Ipswich Road (South) – Northbound nearside lane – Ahead and left turn	101.8%	26.7	110.4%	50.8	114.6%	62.6
A140 Ipswich Road (South) – Northbound offside lane – Ahead only	101.2%	24.7	110.2%	48.8	102.57%	25.0
B1113 – Left turn only	94.4%	13.8	102.5%	25.0	142.8%	19.7
B1113 – Right turn only	98.2%	3.9	106.8%	6.1	98.08%	8.2
Junction Practical Reserve Capacity (PRC)	-13.1%		-22.7%		-58.6%	

Results of operational assessment of A140/B1113 signalised junction						
Total Delay (PCU/Hr)	63.13		138.00		192.01	
Cycle Time (Seconds)	56		56		56	
PM Peak Hour						
	2017 Observed		2022 Baseline		2022 Baseline plus Construction	
	DoS	MMQ	DoS	MMQ	DoS	MMQ
A140 Ipswich Road (North) – Southbound nearside lane – Ahead only	77.0%	12.5	83.7%	15.5	83.7%	15.5
A140 Ipswich Road (North) – Southbound offside lane – Right turn only	94.6%	11.4	102.7%	19.6	143.9%	46.5
A140 Ipswich Road (South) – Northbound nearside lane – Ahead and left turn	104.6%	12.3	113.4%	19.0	75.1%	11.7
A140 Ipswich Road (South) – Northbound offside lane – Ahead only	69.1%	10.1	75.1%	11.7	103.5%	15.4
B1113 – Left turn only	95.2%	9.2	103.5%	15.4	145.4%	19.5
B1113 – Right turn only	98.6%	3.8	107.0%	5.9	102.7%	19.6
Junction Practical Reserve Capacity (PRC)	-16.2%		-26.0%		-61.6%	
Total Delay (PCU/Hr)	38.56		65.15		119.57	
Cycle Time (Seconds)	56		56		56	
DoS: Degree of Saturation MMQ: Mean Max Queue						

1.6.6.2 Table 1.9 shows that the junction currently operates in excess of capacity during the network AM and PM peak hours with Degree of Saturations (DoS) in excess of 100%. In 2022, with no construction traffic, the A140/B1113 signalised junction is predicted to remain operating in excess of capacity, with the highest DoS of 113.4% on the A140 Ipswich Road (South) Northbound ahead and left turn with a mean maximum queue length of 19 PCUs during the PM peak hour. With the additional traffic associated with construction a maximum DoS of 145.4% is predicted on the B1113 left turn movement during the PM peak hour with a mean maximum queue of 20 PCUs.

1.6.6.3 The performance of this junction, and any appropriate traffic management measures required to be adopted by the project will be discussed further with NCC.

1.6.7 Operational assessment of A148/B1149/B1110 four-arm roundabout

1.6.7.1 Operational assessments have been undertaken of the A148/B1149/B1110 four-arm roundabout using the ARCADY model contained within the Junctions9 computer modelling software. Details of the operational assessments are provided in Appendix F whilst Table 1.10 summarises the results for the base year of 2017 and a baseline year of 2022 with and without construction traffic.

Table 1.10: Results of operational assessment of A148/B1149/B1110 junction.

Arm	2017 Baseline				2022 Base				2022 + Construction			
	AM Peak		PM Peak		AM Peak		PM Peak		AM Peak		PM Peak	
	RFC	Queue	RFC	Queue	RFC	Queue	RFC	Queue	RFC	Queue	RFC	Queue
A148 (E)	0.28	0.4	0.45	0.8	0.31	0.4	0.49	1	0.32	0.5	0.52	1.1
B1149	0.33	0.5	0.19	0.2	0.36	0.6	0.21	0.3	0.38	0.6	0.24	0.3
B1110	0.18	0.2	0.1	0.1	0.21	0.3	0.11	0.1	0.21	0.3	0.12	0.1
A148 (N)	0.26	0.4	0.4	0.7	0.29	0.4	0.44	0.8	0.31	0.5	0.48	0.9

1.6.7.2 As can be seen from Table 1.10, the analysis indicates that the junction is predicted to operate well within capacity with a Ratio of Flow to Capacity (RFC) significantly below 1.0 along all approaches during the 2022 and 2032 'With Construction' peak hours.

1.6.7.3 Forecast levels of queuing along the approaches would be minimal, demonstrating that the access junction layout can accommodate the future year construction traffic flows generated by the proposed development in a satisfactory manner.

1.6.8 Operational assessment of B1149/B1145 four-arm roundabout

1.6.8.1 An operational assessment of the B1149/B1145 four-arm roundabout east of Cawston has been undertaken using the ARCADY model contained within the Junctions 9 computer modelling software. Details of the operational assessments are provided in Appendix F. Table 1.11 summarises the results for the base year of 2017 and a baseline year of 2022 with and without construction traffic.

Table 1.11: Results of operational assessment of B1149/B1145 four-arm roundabout.

Arm	2017 Baseline				2022 Base				2022 + Construction			
	AM Peak		PM Peak		AM Peak		PM Peak		AM Peak		PM Peak	
	RFC	Queue	RFC	Queue	RFC	Queue	RFC	Queue	RFC	Queue	RFC	Queue
B1145 (E)	0.19	0.2	0.21	0.3	0.21	0.3	0.23	0.3	0.22	0.3	0.24	0.3
B1149 (S)	0.27	0.4	0.26	0.4	0.29	0.4	0.29	0.4	0.32	0.5	0.31	0.4
B1145 (W)	0.18	0.2	0.14	0.2	0.2	0.2	0.16	0.2	0.22	0.3	0.2	0.3
B1149 (N)	0.19	0.2	0.23	0.3	0.21	0.3	0.25	0.3	0.24	0.3	0.29	0.4

1.6.8.2 As can be seen from Table 1.11, the analysis indicates that the junction is predicted to operate well within capacity with a RFC significantly below 1.0 along all approaches during the 2022 and 2032 'With Construction' peak hours.

1.6.8.3 Forecast levels of queuing along the approaches would be minimal, demonstrating that the access junction layout can accommodate the future year construction traffic flows generated by the proposed development in a satisfactory manner.

1.6.9 Road crossings

1.6.9.1 Another possible impact of construction will be delays for existing highway users at those points where cables are laid directly across highways thus requiring temporary, partial or total closure of the highway. This is not proposed by Hornsea Three and HDD operations will be undertaken underneath all public roads.

1.6.9.2 Section 1.5.3 details the access points, including those which take access directly from the highway. Traffic management may be required at some of these. The choice of traffic management is based on the turning of construction vehicles in and out of the access, a consideration of the level of traffic using each link, the availability of alternative routes and the space available on each link to allow the introduction of temporary shuttle working (either priority or signal controlled).

1.6.9.3 On lightly trafficked links shuttle working can operate on a priority basis or be managed manually without the need for traffic signals. On busier links it is expected that temporary signals will be used. Illustrative layouts of priority and signal controlled shuttle working sites are shown on Figure 1.1 that is taken from Chapter 8 of the Traffic Signs Manual (DfT/Highways Agency, 2009).

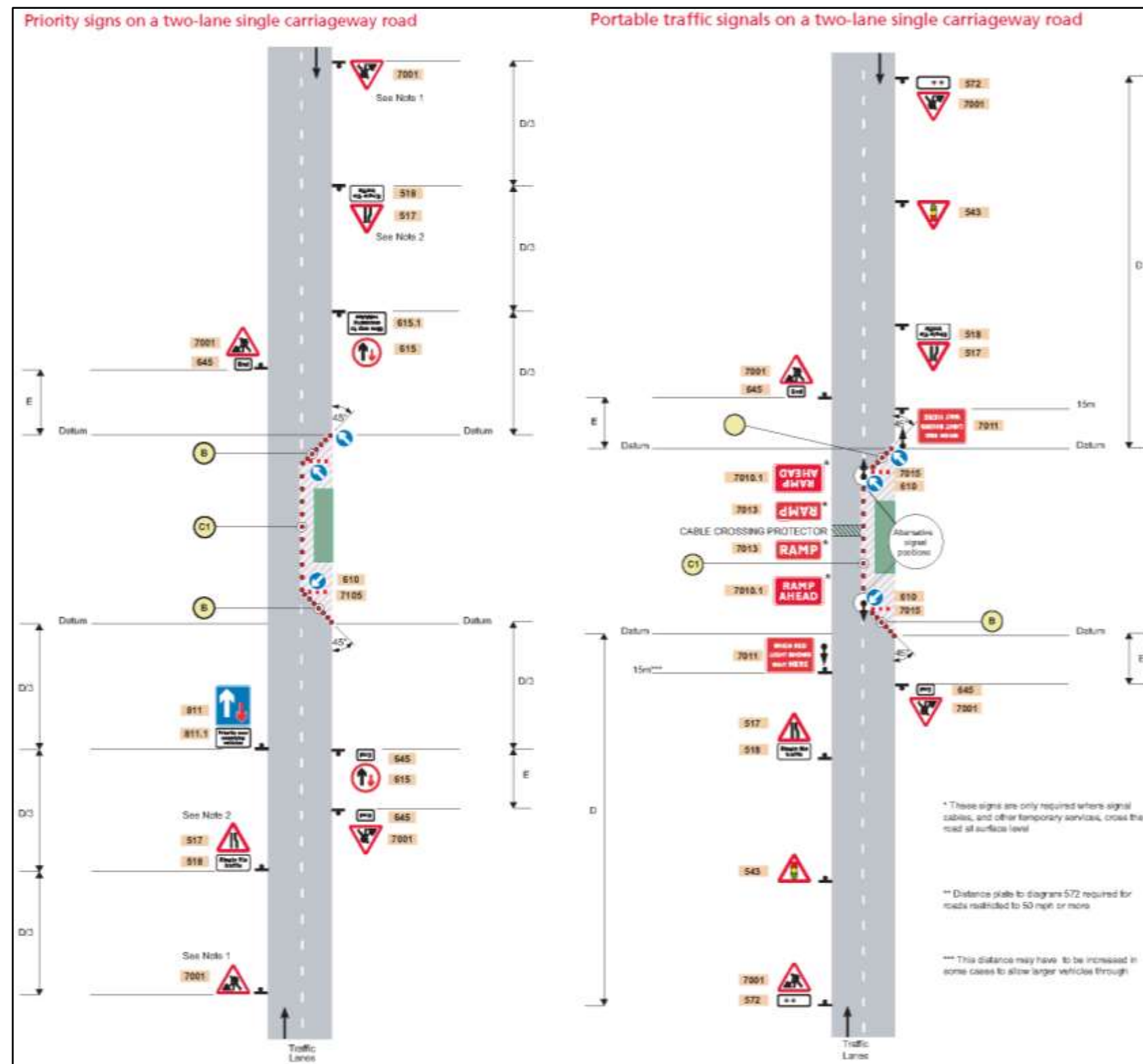

Figure 1.1: Indicative Shuttle Working Arrangements².

² Ref: Chapter 8 of the Traffic Signs Manual (DfT / Highways Agency, 2009)

- 1.6.9.4 The time over which it will be necessary to implement either shuttle working or temporary road closures will be determined by the length of time that access is in use, which is dictated by the length of Hornsea Three onshore cable corridor that it serves. The saving in the overall period of traffic disruption associated with total road closure will therefore need to be weighed against the benefits of maintaining access along a link with shuttle working in those instances when both temporary closure or shuttle working are feasible.
- 1.6.9.5 During periods when construction vehicles travel along the Hornsea Three onshore cable corridor across a road, suitable controls will be put in place to ensure no risk to highways users. These will be specific to each access and will be set out in the subsequent CTMPs secured prior to the commencement of works and activities. At these points the configuration and management of the crossing will prevent non-construction vehicles accessing the onshore cable corridor, prevent construction HGVs from being able to access the onshore cable corridor from the public highway and manage the potential conflict between users of the highway and vehicles passing along the cable corridor. It is expected that all highway crossings will be manned. An indicative crossing arrangement is shown in Figure 1.2 that is taken from Chapter 8 of the Traffic Signs Manual (DfT/Highways Agency, 2009).

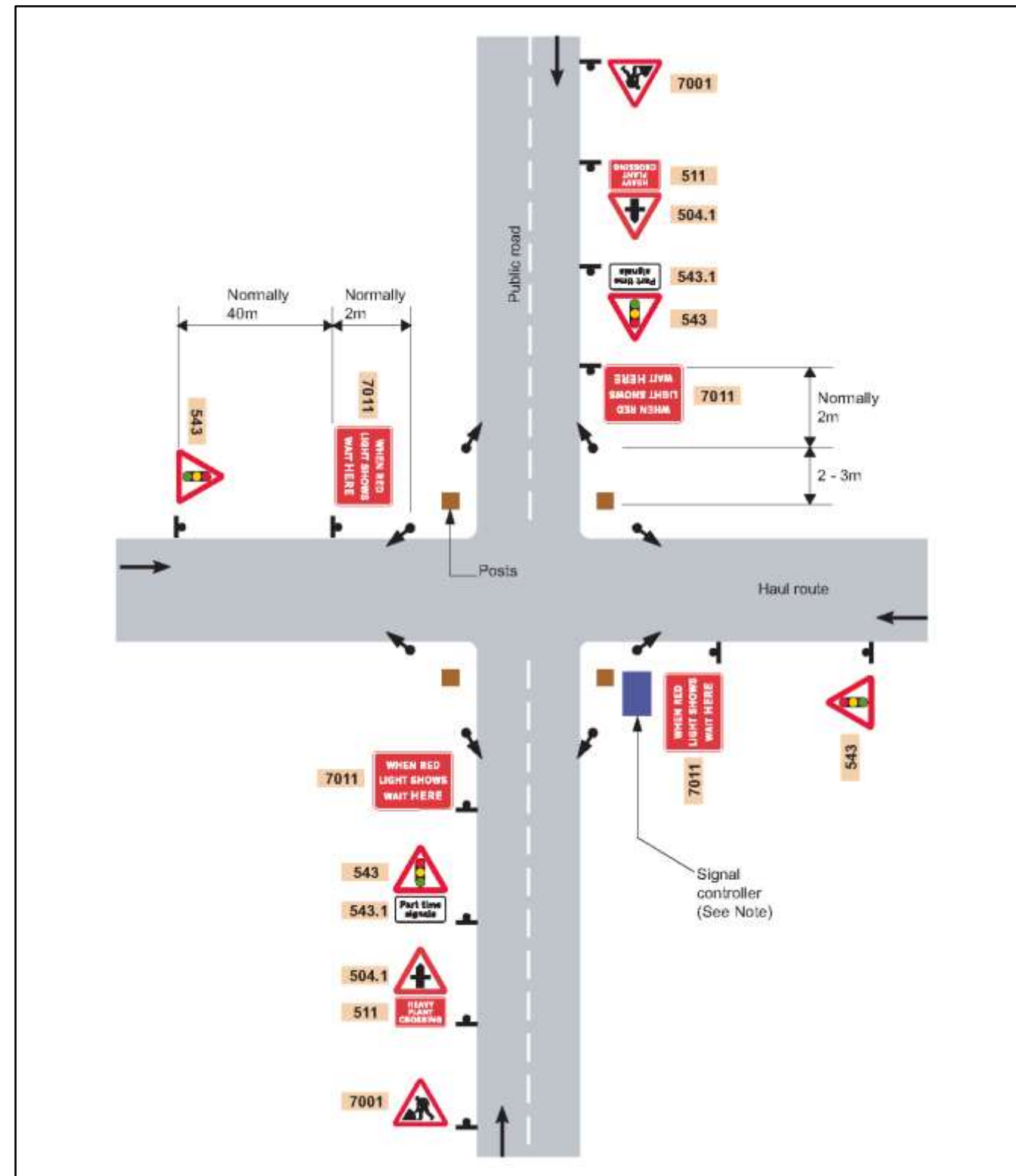

Figure 1.2: Indicative haul crossing route crossing³.

³ Ref: Chapter 8 of the Traffic Signs Manual (DfT / Highways Agency, 2009)

1.6.10 Cumulative developments

1.6.10.1 A number of cumulative developments have been identified in the study area; details of these and the cumulative impact on the local and SRNs are provided in volume 3, chapter 7: Traffic and Transport.

1.6.11 Abnormal indivisible loads

1.6.11.1 The movement of Abnormal Indivisible Loads are low in number (less than 20), will be spread over a period of time and expected to result in no more than one movement in any one day, potentially during the night. The port of entry and the routes the Abnormal Indivisible Loads will take will be influenced from Highways England and Norfolk County Council and will be based upon each port's capabilities to accommodate the large loads and the available routes from these in terms of their geometries and layout being able to accommodate the large vehicles. Highways England and Norfolk County Council can only agree the port of entry and the route once the detailed dimensions and weight of the load, the heavy haulage contractor and the resultant transport vehicle has been defined and the requisite permission is sought to enable such movement.

1.6.11.2 The permission to transport the abnormal indivisible loads will be granted in accordance with the Road Vehicles (Construction and Use) Regulations 1986 and the Motor Vehicles (Authorisation of Special Use) General Order 2003.

1.6.11.3 The ability of the existing Norwich Main Substation access junction to accommodate abnormal indivisible loads has been assessed in relation to typical abnormal indivisible load vehicles. This indicates that a vehicle suitable for the transport of components with a weight of up to 387 tonnes is able to negotiate the Norwich Main Substation access within the existing available carriageway. Should there be a need to transport heavier components there is sufficient verge available to accommodate the vehicle's swept path with suitable temporary ground reinforcement.

1.7 Mitigation of transport impact

1.7.1 Minimisation of traffic generation

1.7.1.1 It is expected that the implementation of measures to encourage staff to travel by alternative modes and thus reduce staff car movements will be difficult on much of the Hornsea Three onshore cable corridor since work sites will move along the onshore cable corridor and much of the area has limited public transport service provision. However, opportunities to encourage staff travel by sustainable modes to the onshore cable corridor will be considered and it is expected that measures to minimise the use of private cars will be implemented at the onshore HVDC converter/HVAC substation site. Details of such measures are established in the Outline CoCP (see document A8.5) and Outline CTMP (see document A8.2) and will form part of the CTMPs which will be agreed with the highway authority.

1.7.1.2 As part of the Outline CoCP (see document A8.5) and in accordance with good construction practice opportunities will be sought to reduce the overall number of HGV movements by combining loads and using the largest feasible vehicles taking into account any other environmental constraints that may affect HGV routes.

1.7.2 Construction site management

1.7.2.1 Wheel washing will be implemented at all construction site access points where there is a risk of mud and debris being carried onto the highway. Details of such measures are established in the Outline CoCP (see document A8.5) and Outline CTMP (see document A8.2) and will form part of the CTMPs which will be agreed with the highway authority.

1.7.2.2 All loads of fine or loose material that could lead to dust will be sheeted. This measure form part of the Outline CoCP (see document A8.5) and Outline CTMP (see document A8.2).

1.7.3 Working hours

1.7.3.1 Working hours are set out in the Outline CoCP (see document A8.5). For the Hornsea Three onshore cable corridor and substation core working hours are to be 07.00 to 18.00 on weekdays and 07.00 to 13.00 on Saturdays. Up to one hour before and after for mobilisation ("mobilisation period") (i.e. 06:00 to 19:00 weekdays and 06:00 to 14:00 Saturdays); and Maintenance period 13:00 to 17:00 Saturdays. Mobilisation does not include HGV movements into and out of sites, but suppliers can make use of the wider highway network outside these hours to travel to site. In certain circumstances, specific works may have to be undertaken on a continuous working basis (00:00 to 00:00 Monday to Sunday).

1.7.3.2 During this continuous working basis period, the contractor may also run support generators, emergency backup supplies, undertake remedial works (for example in the event of severe weather) and operate security of sites and protection of open assets.

1.7.3.3 It may be beneficial to carry out several activities outside of the standard working hours to utilise periods such as abnormal indivisible loads/construction plant delivery, works within the highway, footpaths, works affecting operational railways. Activities outside of the standard working hours will be agreed with the relevant local authority EHO officer in consultation.

1.7.4 HGV routes

1.7.4.1 HGV routes have been carefully selected to minimise the potential for adverse environmental impacts. In some cases, there is no alternative than to use an environmentally sensitive route (sensitive areas are defined in Table 7.13 of volume 3, chapter 7: Traffic and Transport) to access part of the works site (or the only alternatives would have greater environmental sensitivity). In these cases, measures such as controls on the timing of HGV deliveries (see below) will be implemented to minimise the environmental impact.

1.7.5 HGV timing

1.7.5.1 There are schools in some areas of the network where HGVs may have to route nearby. It is therefore proposed to restrict HGV operating times in these locations to avoid school opening and closing times. Details of these measures, specifically taking into account the opening and closing times of local schools are set out in the Outline CoCP (see document A8.5).

1.7.6 Video Surveys

1.7.6.1 Video condition surveys will be undertaken before the start of the works and after the substantial completion of works on minor links used by HGVs to access the Hornsea Three onshore cable corridor. Damage to the highway caused by construction traffic will be repaired by the developer or a financial contribution made to the relevant NCCs to cover the cost of remedial works.

1.7.7 Traffic management

1.7.7.1 Traffic management will be implemented at some accesses to maintain highway safety and to ensure minimal delays to existing road users. An indicative design of shuttle working at a road crossing is provided in Figure 1.1. The detailed design of shuttle workings at road crossings will be undertaken prior to construction and agreed with the relevant highway authority.

1.7.7.2 Where temporary road closures are required, for example, when accesses are being formed discussions will be held with the relevant highway authority to agree the timing and duration of closures and measures such as advance warnings and the signing of diversions to minimise delays to highway users.

1.7.7.3 On some highway links it may be necessary to implement vehicle management measures to minimise the risk of large vehicles meeting on narrow sections of highway where passing opportunities are limited. The vehicle management may involve scheduling movements or controlling the times when vehicles enter and leave sites.

1.7.7.4 Where the Hornsea Three onshore cable corridor crosses highway links and it is necessary for vehicles to pass along the onshore cable corridor across the road, the crossing will be constructed and managed in accordance with the indicative layout shown in Figure 1.2. This will maintain site security, eliminate the risk of members of the public turning onto the onshore cable corridor and prohibit the use of the crossing for HGV access. Each crossing will be manned so that the potential conflict between highway users and construction vehicles can be managed.

1.7.8 Parking

1.7.8.1 Appropriate parking will be provided for construction vehicles to avoid the need for parking on the highway.

1.7.9 A47 improvement schemes

1.7.9.1 The A47 improvement works at the A47/A11 Thickethorne interchange, the A47 at Easton and A47 at Swardeston may coincide with Hornsea Three construction phase. The plans for these improvements are still evolving and are not yet fixed, however, Ørsted and NCC have had initial discussions regarding the two projects and their potential interaction and further discussions will take place post submission.

1.7.10 Abnormal indivisible loads

1.7.10.1 The port of entry and the routes the Abnormal Indivisible Loads will take will be influenced from HE and NCC and will be based upon each port's capabilities to accommodate the large loads and the available routes from these in terms of their geometries and layout being able to accommodate the large vehicles. The management of the movement itself will be agreed with HE, NCC and the police and will be subject to the normal procedures for transporting abnormal indivisible loads not just for their own safe passage but also for the safety of all other road users.

1.7.11 Measures adopted as part of Hornsea Three

1.7.11.1 A summary of the measures adopted as part of Hornsea Three is set out in Table 1.12.

Table 1.12: Measures adopted as part of Hornsea Three.

Measures adopted as part of Hornsea Three	Justification
Suitable HGV routes have been identified.	To avoid adverse effects on communities and road users.
Video condition surveys will be undertaken before HGVs make use of a section of road and after the substantial completion of works on minor links used by HGVs to access the Hornsea Three onshore cable corridor. Damage to the highway caused by construction traffic will be repaired.	To ensure that construction traffic has no lasting adverse impact on the condition of highways.
A route for abnormal indivisible loads will be identified between the SRN and the relevant onshore infrastructure (i.e. onshore HVAC booster station and HVDC converter/HVAC substation). The route, timing and method of transport of abnormal indivisible loads will be discussed and agreed with HE, the police and relevant highways and bridge authorities.	To avoid damage to inappropriate highways, to minimise delays and risks to road users and to avoid adverse impacts on local communities.
<p>Working hours are set out in the Outline CoCP (see document A8.5). For the Hornsea Three onshore cable corridor and substation core working hours are 07.00 to 18.00 on weekdays and 07.00 to 13.00 on Saturdays. Up to one hour before and after for mobilisation ("mobilisation period") (i.e. 06:00 to 19:00 weekdays and 06:00 to 14:00 Saturdays); and Maintenance period 13:00 to 17:00 Saturdays. Mobilisation does not include heavy good vehicle (HGV) movements into and out of sites, but suppliers can make use of the wider highway network outside these hours to travel to site. In certain circumstances, specific works may have to be undertaken on a continuous working basis (00:00 to 00:00 Monday to Sunday).</p> <p>During this continuous working basis period, the contractor may also run support generators, emergency backup supplies, undertake remedial works (for example in the event of severe weather) and operate security of sites and protection of open assets.</p> <p>It may be beneficial to carry out several activities outside of the standard working hours to utilise periods such as abnormal loads/construction plant delivery, works within the highway, footpaths, works affecting operational railways. Activities outside of the standard working hours will be agreed with the relevant local authority EHO officer in consultation.</p>	<p>The use of core construction hours will minimise noise impacts (see volume 3, chapter 8; Noise and Vibration), however in some circumstances extended or continuous working hours could be requested to reduce the magnitude of environmental impacts of construction (e.g. to increase safety, reduce driver delays or reduce the duration of impacts etc.).</p>
Restrictions on HGV operating hours, along those sections of the highway network that provide access to local schools.	To minimise adverse impacts on local communities and vulnerable highway users.
Where there is a risk of mud being deposited on the road, wheel wash facilities will be provided at each construction site. These include dry wheel 'wash' facility (rumble grids).	To eliminate risks to highway users resulting from mud and debris on the highway.
The progression of Temporary Traffic Regulation Orders for a temporary 30 mph speed restriction at every site access which does not already have such a speed limit.	To reduce vehicle speeds, improve driver awareness of construction activity and to minimise any potential road safety issues arising.
Measures to minimise dust and dirt associated with the movement of construction vehicles are set out in the Outline CoCP (see document A8.5).	To minimise adverse air quality effects (see volume 3, chapter 9: Air Quality).
The provision of appropriate parking facilities for construction workers.	To eliminate risks associated with inappropriate parking.
Traffic management measures at those points where cable trenches are cut across highways or where existing access rights are affected.	To minimise delays to existing highway users and to maintain highway safety.
The diversion of footways or any other rights of way that may be affected by the construction works with closures only when absolutely necessary (see volume 3, chapter 6: Land Use and Recreation).	Closure of rights of way minimise risks to members of the public resulting from construction works. Diversions minimise delays and inconvenience to pedestrians, cyclists and equestrians.
Monitor load sizes and vehicle usage and, where possible, load consolidation and delivery to construction sites using alternative vehicles. Encouragement to re-use HGVs wherever possible, such as backloading. Where suitable, local suppliers will be used to minimise the distance travelled by HGVs.	To minimise the impact on sensitive receptors.
Where possible the appointed contractor should seek to minimise overall vehicle movement generation through measures to encourage and promote sustainable travel and transport, for example by using a minibus to shuttle staff between key pick up locations and the compounds (main compound and secondary compounds).	To minimise overall emissions and to minimise other traffic and transport impacts.
Local management of vehicle movements to minimise the risks of vehicles meeting each other on narrow sections.	To minimise highway risk and possible delays.
The design of HGV access points, including visibility standards and, where necessary, temporary speed restrictions on the adjacent highway will be agreed with the relevant Highway Authorities.	To maintain highway safety.
At all vehicle accesses where accommodation works are undertaken to allow the movement of vehicles between the Hornsea Three onshore cable corridor and the highway the original highway will be reinstated after construction work is completed.	To ensure the ongoing safe and efficient functioning of the highway.

Measures adopted as part of Hornsea Three	Justification
<p>It is expected that a number of abnormal indivisible loads comprising large components such as transformers will be transported to the onshore HVDC converter/HVAC substation site. The haulage contractor appointed to undertake this work will be required to comply with statutory regulations in terms of consulting with HE, police and Local Highway Authorities. The notification requirements differ depending on the weight, length and width of the abnormal indivisible load.</p>	<p>To minimise disruption and driver delay.</p>
<p>The timing of abnormal indivisible load deliveries will be discussed with the relevant highway authorities to minimise delay for other road users and to minimise risk to highway users. The timing of abnormal indivisible load deliveries to the onshore HVDC converter/HVAC substation will be discussed to ensure that there is no adverse impact on the access road in terms of delays to vehicles using the site.</p>	<p>To minimise disruption and driver delay.</p>
<p>The routing of abnormal indivisible load deliveries will be agreed with the relevant highway authorities. The delivery of abnormal indivisible loads would typically be undertaken in convoy and under escort. Where abnormal indivisible loads require the full width of the carriageway or for unusual manoeuvres at junctions, appropriate temporary road closures and traffic management will be put in place as appropriate to maintain the safety of other road users.</p>	<p>To minimise disruption and driver delay.</p>
<p>An Outline CTMP (see document A8.2) and an Outline CoCP (see document A8.5), which establish the principles that any subsequent CTMPs and CoCPs will follow, are submitted with this application. The CTMPs form part of the CoCPs. The draft DCO submitted with the application requires that no phase of any works landward of MLWS may commence until, for that phase, a CoCP (which must accord with the Outline CoCP) has been submitted to, and approved by, the relevant planning authority, in consultation with the relevant highway authority (and if applicable the MMO).</p>	<p>This is to minimise the impacts of construction vehicle movements associated with Hornsea Three and to manage those movements in a manner that road safety is maintained. .</p>
<p>Depending on the times of construction of individual Hornsea Three onshore cable corridor sections, HGVs will avoid tourist routes where possible during peak holiday season (or avoid tourist routes where possible during peak hours of the day). Management measures will be captured in CTMPs which will be developed in consultation with Norfolk County Council (NCC) as the Local Highway Authority (LHA) and Highways England (HE), prior to submission to the Local Planning Authorities for approval.</p>	<p>To seek to minimise any disruption during these periods.</p>

1.8 Development consent order

- 1.8.1.1 It is intended that the main consents and licenses associated with the implementation of the construction works will be obtained through the DCO process.
- 1.8.1.2 The specific aspects of the works that are expected to be secured through the DCO process comprise the following:
- Works on the highway at temporary HGV access points;
 - Temporary road closures and stopping up of highways at road crossings; and
 - The requirement for a CoCP based upon the Outline CoCP (see document A8.5) submitted with the DCO application.

1.9 Summary and conclusion

- 1.9.1.1 This TA assesses the transport impact of the construction phase of the onshore elements of Hornsea Three, together with the compounds (including main construction compound) and storage areas associated with the Hornsea Three offshore wind farm. The report has been prepared as an annex to the volume 3, chapter 7: Traffic and Transport required under the Infrastructure Planning (Environmental Impact Assessment) Regulations 2009 (EIA Regulations).
- 1.9.1.2 The transport impact of the construction of the onshore elements of Hornsea Three, together with the compounds (including main construction compound) and storage areas is expected to be related to the movement of materials, equipment and staff and to temporary changes in the highway network where trenches are dug across highways.
- 1.9.1.3 Onshore work is planned to commence in 2021, however it could commence as early as 2020. Hornsea Three could be built using two-phase or a single-phase construction programme. Under a two-phase programme scenario, the sum of the durations of each phase of Hornsea Three onshore cable corridor construction would not exceed eight years assuming gaps between the phases of up to 3 years. Under a single-phase construction programme, the total duration of the onshore cable corridor construction would not exceed six years.
- 1.9.1.4 The level of traffic associated with the construction of the project has been informed by the engineering requirements associated with the various works. Where there is some uncertainty about elements of the construction, worst case assumptions have been adopted to ensure that all potential impacts are identified. In particular, it has been assumed, as a worst case, that the whole of the Hornsea Three onshore cable corridor haul road will be surfaced with aggregate and that all of the road will be removed at the end of the construction period.
- 1.9.1.5 It is estimated that over the whole construction period the project will generate around 273,000 construction worker vehicle movements (cars). This equates to around 2,600 light vehicle movements per day on average spread over the various work sites for the duration of the construction programme.
- 1.9.1.6 A sensitivity assessment of the percentage increase in daily link flows resulting from construction activity indicates that the maximum daily increase in daily link flows on the basis of worst case assumptions is 17.9% on the B1145 east of Cawston.
- 1.9.1.7 It is concluded that the construction vehicle movements associated with the project will not have any significant impact on the operation of links or junctions within the study area which cannot be mitigated through measures outlined in volume 3, chapter 7: Traffic and Transport.

- 1.9.1.8 An assessment has been made of the potential impact of road crossings. A number of roads are crossed using HDD and are therefore not affected by the crossing. Where it is necessary to lay cables across links it is proposed to either introduce a temporary closure or introduce temporary shuttle working as cable ducts are laid across one and then the other side of the road while allowing shuttle working on the side of the road that is kept open. Shuttle working is proposed in all cases where no alternative routes are available.
- 1.9.1.9 Orsted will continue to engage with NCC in relation to the planned improvement works on the A47.
- 1.9.1.10 The port of entry and the routes the Abnormal Indivisible Loads will take will be influenced from HE and NCC and will be based upon each port's capabilities to accommodate the large loads and the available routes from these in terms of their geometries and layout being able to accommodate the large vehicles.
- 1.9.1.11 The main consents and licenses associated with the implementation of the construction works will be obtained through the DCO process.

Appendix A HGV Vehicle Movements per Access Point

HGV Movements per Access Point

Cable Route Section	Description	Total Two-Way Light Vehicle Movements	Total Two-Way HGV Movements	Duration / Days	Daily Two-Way HGV Movements	Accesses															Number of Construction Accesses	*Daily HGVs per access			
Landfall	Landfall	9,600	4,800	550	5	47(B)																	1	5	
1	Landfall to Holgate Hill	5,528	18,737	180	104	47(B)	45(B)	44(B)	ACC_P_75															4	26
2	Holgate Hill to woodland north east of High Kelling	3,139	9,854	102	96	42(C)	41(B)																	1	96
3	Woodland northeast of High Kelling to woodland south of Church Road	4,612	14,586	150	97	ACC_P_74	ACC_P_73	ACC_P_72	ACC_P_71	ACC_P_70	ACC_P_69													6	16
4	Woodland south of Church Road to woodland south and east of School Lane	5,163	15,727	170	94	ACC_P_68	ACC_P_67	39a(B)																3	31
5	Woodland east of School Lane to Plumstead Road	3,782	11,494	124	94	ACC_P_66	ACC_P_65	ACC_P_64	ACC_P_63	ACC_P_62	ACC_P_61													6	16
6	Plumstead Road to the B1149	4,871	16,733	158	106	37(E)	ACC_P_60																	2	53
7	B1149 to land South of Town Close Lane	3,315	10,391	108	96	ACC_P_59	ACC_P_58	ACC_P_57	36(C)	ACC_P_56	35(C)													3	32
8	Land south of Town Close Lane to woodland north of Reepham Road	9,180	28,030	300	94	ACC_P_55	ACC_P_54	ACC_P_53	ACC_P_52	ACC_P_51	ACC_P_50	ACC_P_49	ACC_P_48											8	12
9	Land north of Reepham Road to woodland north of Reepham	4,118	12,530	133	94	ACC_P_47	ACC_P_46	34(A)	33(A)	ACC_P_45	ACC_P_44													6	16
10	Woodland north of Reepham to woodland at Booton Common	3,539	11,081	114	96	ACC_P_43	ACC_P_42	32(B)/31(B)																3	32
11	Woodland east of Reepham to The Grove	4,211	13,321	137	97	ACC_P_41	ACC_P_40																	2	49
12	The Grove to woodland south of Church Farm Lane	4,524	13,767	149	94	ACC_P_39	ACC_P_38	ACC_P_37	ACC_P_36	ACC_P_35	ACC_P_34													6	16
13	Woodland south of Church Farm Lane to River Wensum	4,262	13,296	139	96	29(B)	29(B)	ACC_P_33	ACC_P_32	28(C)	27(C)	26(B)	25(B)											6	16
14	River Wensum to woodland south west of Ringland	10,094	31,155	330	94	ACC_P_31	ACC_P_30	24(A)	ACC_P_29	ACC_P_28	ACC_P_27	ACC_P_26	23(A)	ACC_P_25	ACC_P_24	22(B)	ACC_P_23	ACC_P_22	21(B)	20(B)				14	7
15	Woodland south west of Ringland to A47	3,250	10,518	106	99	18(B)	17(B)	16(A)																3	33
16	A47 to Bawburgh Road	4,882	15,363	158	97	ACC_P_21	ACC_P_20	15(A)	ACC_P_19	14(A)														4	24
17	Bawburgh Road to woodland west of Little Melton	6,415	19,891	209	95	ACC_P_18	13(C)	ACC_P_17	ACC_P_16	ACC_P_15	ACC_P_14													5	19
18	Woodland west of Little Melton to A11	7,152	22,152	231	95	11(A)	ACC_P_13	10(A)	9(A)	ACC_P_12	ACC_P_11	ACC_P_10	ACC_P_9	8(A)	7(A)	ACC_P_8	6(B)	50(B)	5(A)	4(C)/4(B)	3(B)			16	6
19	A11 to woodland north west of Swardston	5,006	15,246	163	94	2(B)	ACC_P_7	ACC_P_6	ACC_P_5	ACC_P_4														5	19
20	Woodland north west of Swardston to B1113	3,398	10,465	110	95	ACC_P_3	ACC_P_2	1(B)																3	32
21	B1113 to end of cable route	3,923	17,786	127	140	ACC_P_1	ACC_P_A	ACC_P_B	ACC_P_C	ACC_P_D	A(B)													2	70
HVAC Booster Station	Booster Station	24,012	6,597	275	12	37(E)																		1	12
HVAC Substation	Converter / Sub Station	135,000	24,012	825	29	ACC_P_1																		1	29
																								111	665

Monitoring Access only
Crossing Point Only

*Excluding Monitoring Accesses and Crossing Points

Appendix B Traffic Flows

Appendix B Traffic Flow Diagrams
Hourly Construction HGV Flows

Assumptions for HGVS

Assessment year of **2022** as this is the first full year of construction of the cable route

Assume that the majority of HGVs will route from Lings Kynn, Great Yarmouth and Lowestoft

Assume 10% from Kings Lynn
5% from Great Yarmouth
5% from Lowestoft
35% from A47
0% from A1065
35% from A11
10% from A140 south
0% from A140 north

100%

Assume **4** groups of **5** workfronts
5 adjacent workfronts to assume worst case scenario

Assume **50%** of total staff movements occur between 07:00 and 08:00
50% of total staff movements occur between 18:00 and 19:00

In reality, staff will **arrive 06:00-07:00**
depart 18:00-19:00

The local road network, for assessment purposes only, assumes staff will **arrive 07:00-08:00**
depart 18:00-19:00

The trunk road network staff assignment has staff, as predicted, **arriving 06:00 - 07:00**
departing 18:00-19:00

Assumptions for Staff

Assessment year of **2022** as this is the first full year of construction of the cable route

Assume that all staff will route via the wider highway network (A and Trunk Roads)

Assume 8% via A148
28% via A47 east
11% from A146
7% from A47 west
6% from A1065
16% from A11
13% from A140 south
12% from A140 north

100%

Assume **4** groups of **5** workfronts
5 adjacent workfronts to assume worst case scenario

Assume **50%** of total staff movements occur between 07:00 and 08:00
50% of total staff movements occur between 18:00 and 19:00

Tables Linked to Construction Vehicle Movements 2 x 7m Spreadsheet

Route Section	Description	Hourly Vehicle Flows			
		Total	HGV	Lights	Group
1	Landfall to Holgate Hill		9		Northern
2	Holgate Hill to woodland north east of High Kelling		9		Northern
3	Woodland northeast of High Kelling to woodland south of Church Road		9		Northern
4	Woodland south of Church Road to woodland south and east of School Lane		9		Northern
5	Woodland east of School Lane to Plumstead Road		9		Northern
6	Plumstead Road to the B1149		10		Middle (northern)
7	B1149 to land South of Town Close Lane		9		-
8	Land south of Town Close Lane to woodland north of Reepham Road		9		Middle (northern)
9	Land north of Reepham Road to woodland north of Reepham		9		Middle (northern)
10	Woodland north of Reepham to woodland at Booton Common		9		Middle (northern)
11	Woodland east of Reepham to The Grove		9		Middle (northern)
12	The Grove to woodland south of Church Farm Lane		9		Middle (southern)
13	Woodland south of Church Farm Lane to River Wensum		9		Middle (southern)
14	River Wensum to woodland south west of Ringland		9		Middle (southern)
15	Woodland south west of Ringland to A47		9		Middle (southern)
16	A47 to Bawburgh Road		9		Middle (southern)
17	Bawburgh Road to woodland west of Little Melton		9		Southern
18	Woodland west of Little Melton to A11		9		Southern
19	A11 to woodland north west of Swardeston		9		Southern
20	Woodland north west of Swardeston to B1113		9		Southern
21	B1113 to end of cable route		13		Southern
Landfall	Landfall		0		
Booster Station	Booster Station		1		
Converter / Sub Station	Converter / Sub Station		3		
Total:		0	192	0	192

HGVs	10%	from Kings Lynn via A148	Staff Vehicle Movements	8%	via A148
Assume	5%	from Great Yarmouth	Assume	28%	via A27 east
	5%	from Lowestoft		11%	from A146
	35%	from A47		7%	from A27 west
	0%	from A1065		6%	from A1065
	35%	from A11		16%	from A11
	30%	from A140 south		13%	from A140 south
	10%	from A140 north		12%	from A140 north
	10%			10%	

- 0** Light Vehicles
- 5** One-Way HGVs
- 9** Two-Way HGVs

Route Section 1

10	Light Vehicles
10	Heavy Goods Vehicles (HGVs)

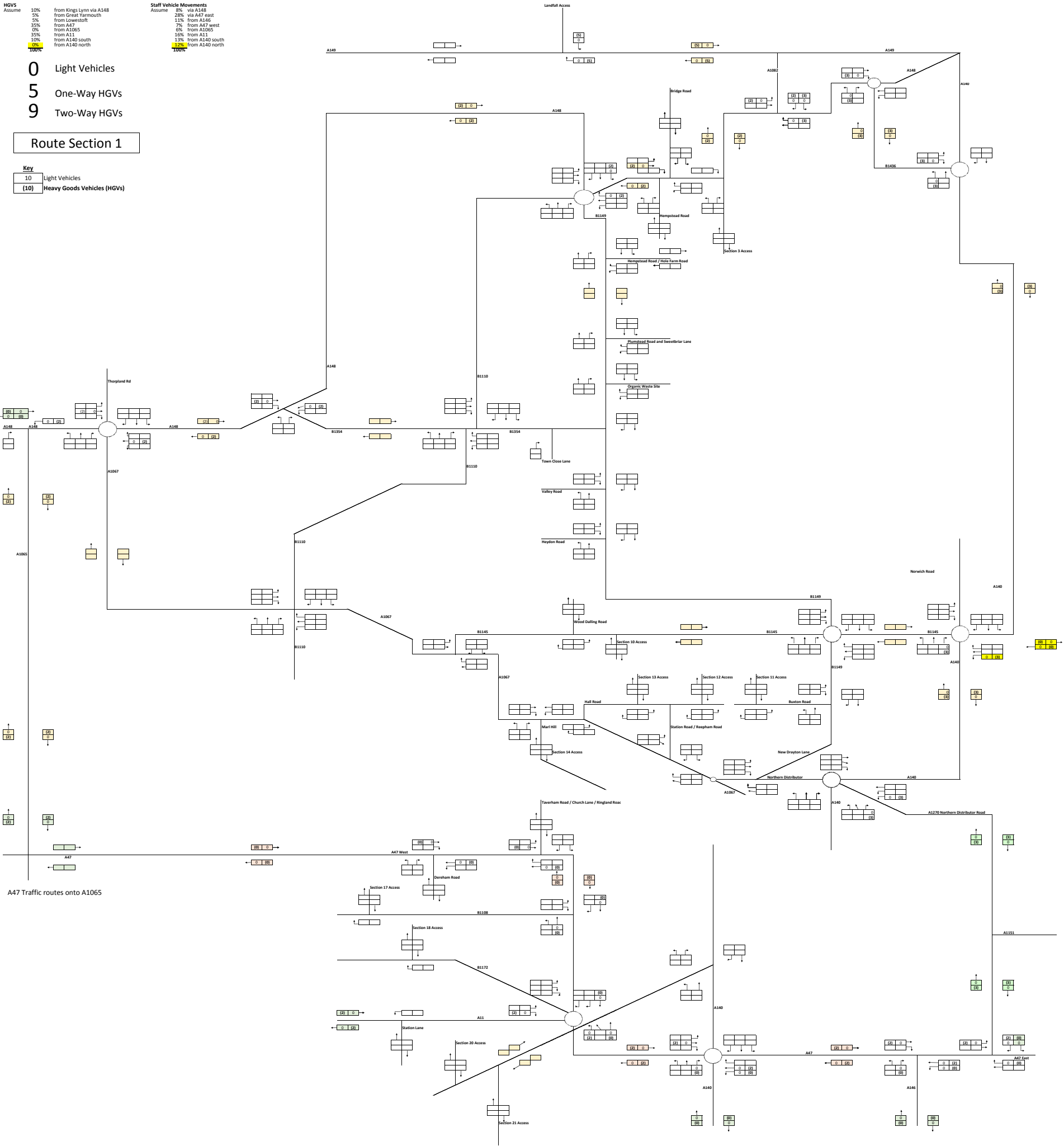

A47 Traffic routes onto A1065

HGVs Assume		Staff Vehicle Movements Assume	
10%	from Kings Lynn via A148	8%	via A148
5%	from Great Yarmouth	28%	via A47 east
5%	from Lowestoft	11%	from A146
35%	from A47	7%	from A47 west
0%	from A1065	6%	from A1065
35%	from A11	16%	from A11
10%	from A140 south	13%	from A140 south
10%	from A140 north	12%	from A140 north
10%		10%	

- 0 Light Vehicles
- 4 One-Way HGVs
- 9 Two-Way HGVs

Route Section 2

Key	
10	Light Vehicles
10	Heavy Goods Vehicles (HGVs)

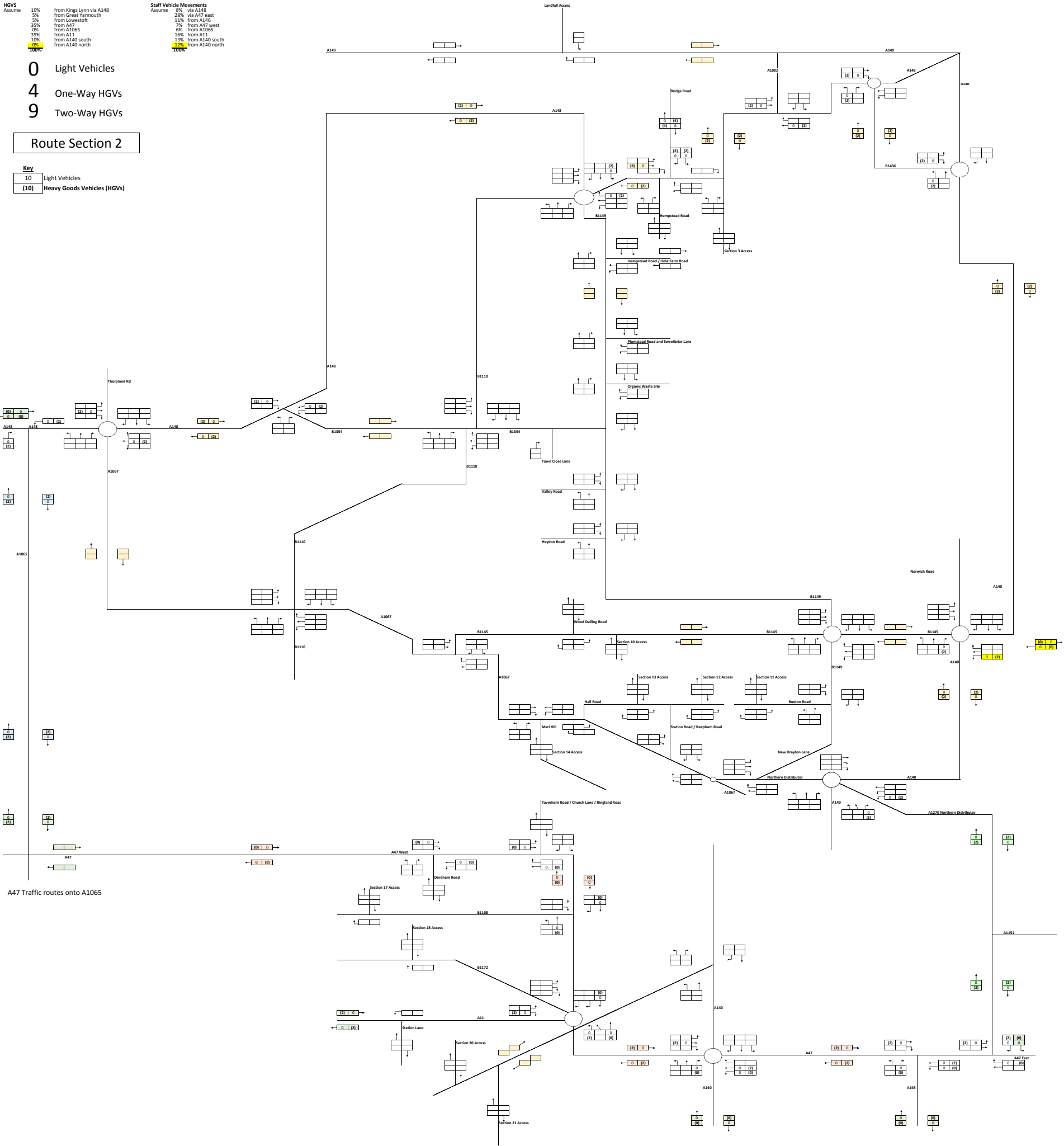

A47 Traffic routes onto A1065

HGVs		
Assume	10%	from Kings Lynn via A148
	5%	from Great Yarmouth
	5%	from Lowestoft
	35%	from A47
	0%	from A1065
	35%	from A11
	10%	from A140 south
	10%	from A140 north
	100%	from A140 north

Staff Vehicle Movements		
Assume	8%	via A148
	28%	via A47 east
	11%	from A146
	7%	from A47 west
	6%	from A1065
	16%	from A11
	13%	from A140 south
	12%	from A140 north
	100%	from A140 north

- 0** Light Vehicles
- 4** Total HGVs
- 9** Two-Way HGVs

Route Section 3

Key	
10	Light Vehicles
10	Heavy Goods Vehicles (HGVs)

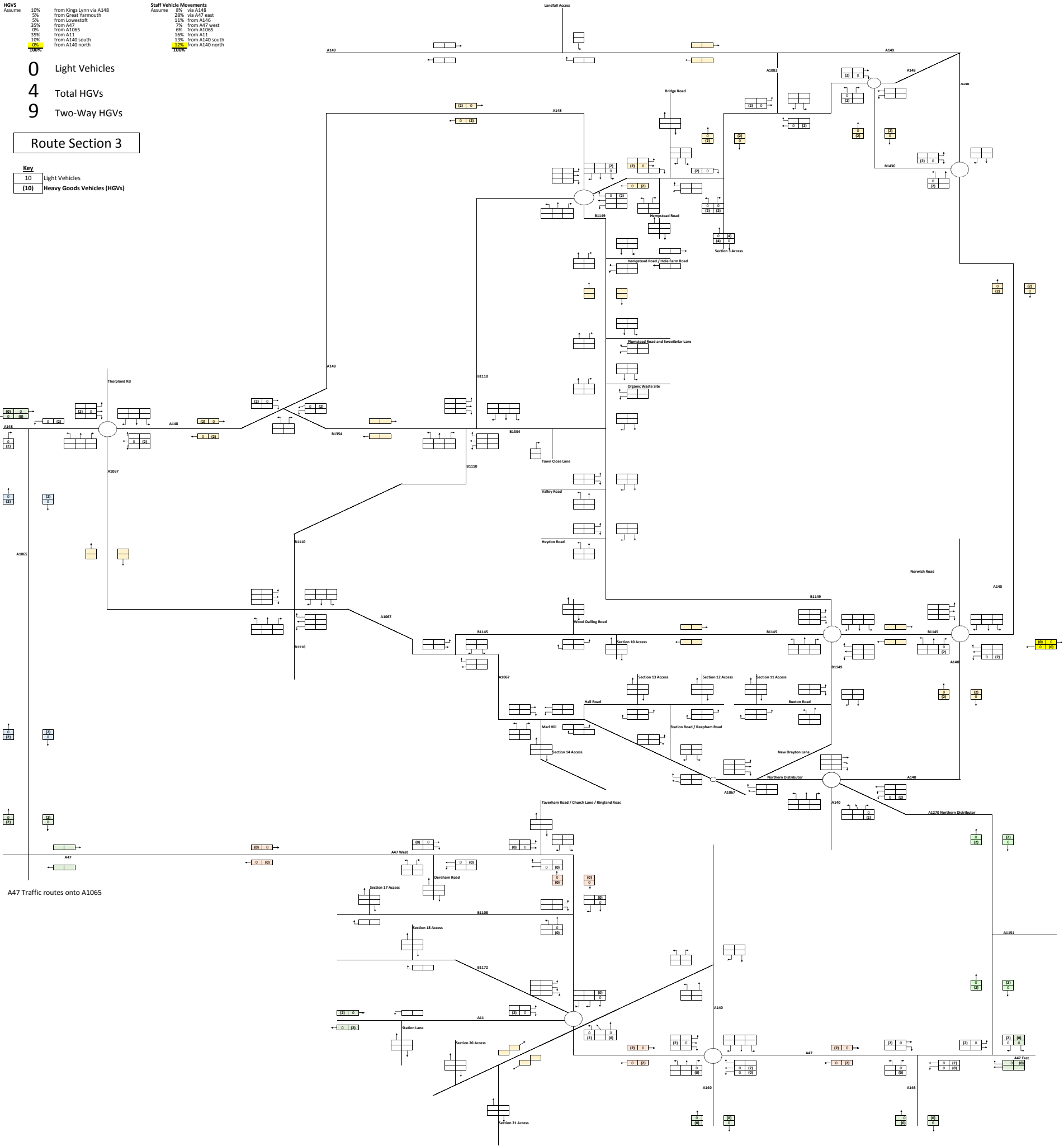

HGVs Assume		Staff Vehicle Movements Assume	
10%	from Kings Lynn via A148	8%	via A148
5%	from Great Yarmouth	28%	via A47 east
5%	from Lowestoft	11%	from A146
35%	from A47	7%	from A47 west
0%	from A1065	6%	from A1065
35%	from A11	16%	from A11
30%	from A140 south	13%	from A140 south
10%	from A140 north	12%	from A140 north
100%		100%	

- 0 Light Vehicles
- 4 Total HGVs
- 9 Two-Way HGVs

Route Section 4

Key	
10	Light Vehicles
10	Heavy Goods Vehicles (HGVs)

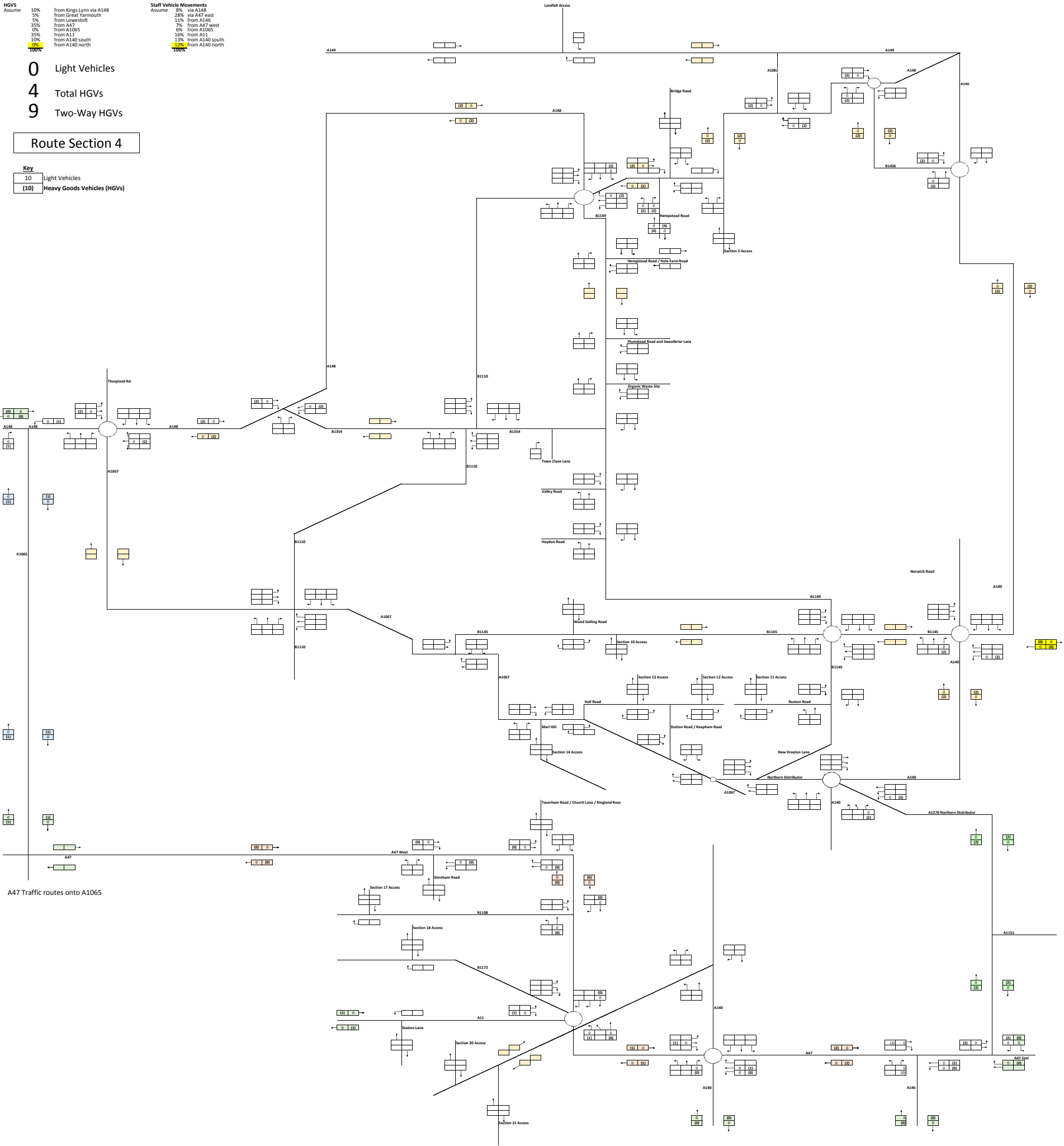

A47 Traffic routes onto A1065

HGVs Assume	10%	from Kings Lynn via A148	Staff Vehicle Movements Assume	8%	via A148
	5%	from Great Yarmouth		28%	via A27 east
	5%	from Lowestoft		11%	from A146
	35%	from A47		7%	from A27 west
	0%	from A1065		6%	from A1065
	35%	from A11		16%	from A11
	10%	from A140 south		13%	from A140 south
	10%	from A140 north		12%	from A140 north
	10%			20%	

- 0** Light Vehicles
- 4** Total HGVs
- 9** Two-Way HGVs

Route Section 5

Key	
10	Light Vehicles
10	Heavy Goods Vehicles (HGVs)

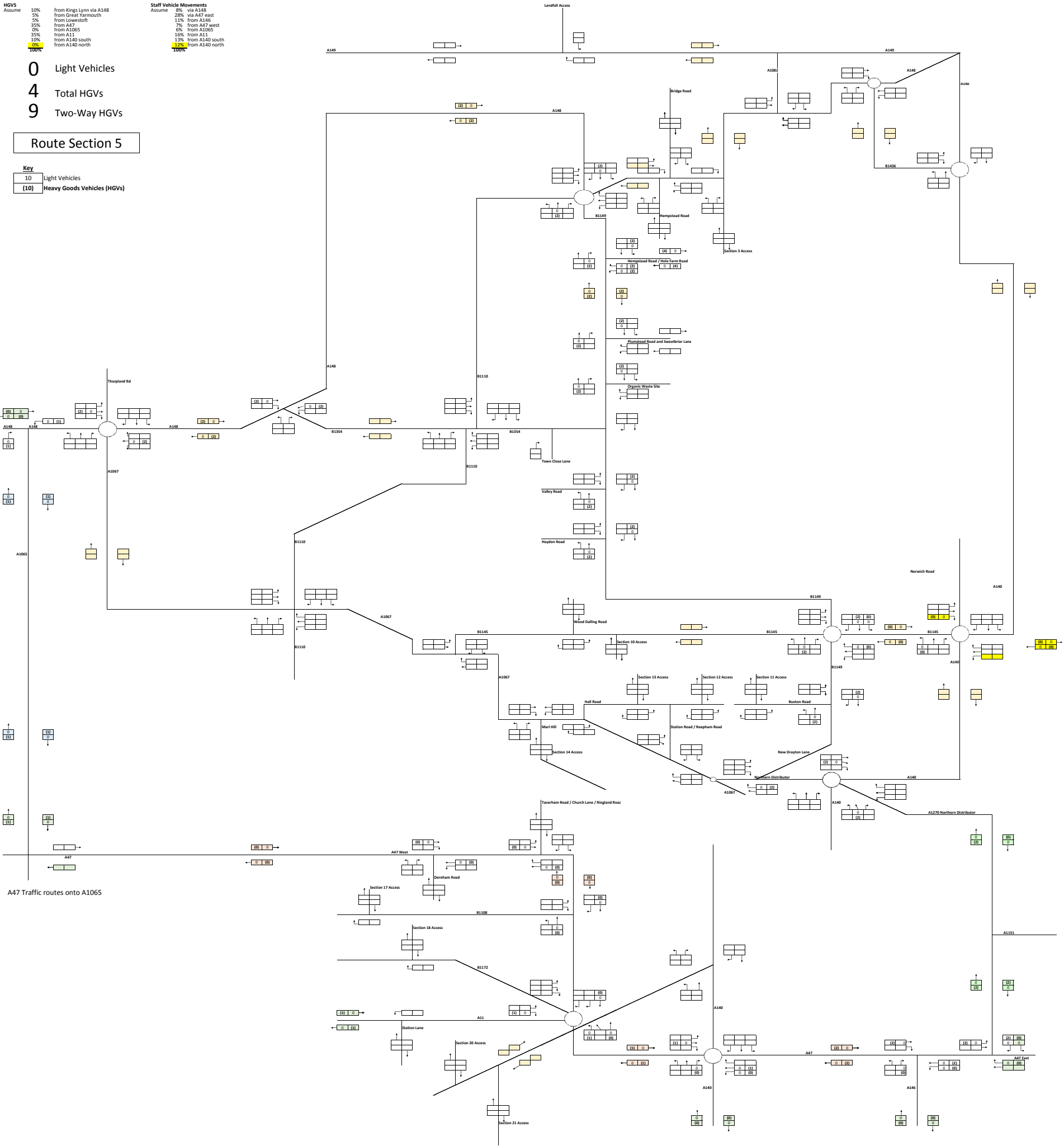

Northern Group Total

0 Light Vehicles
 22 Total HGVs
 44 Two-way HGVs

Key	
10	Total Vehicles
(10)	Heavy Goods Vehicles (HGVs)

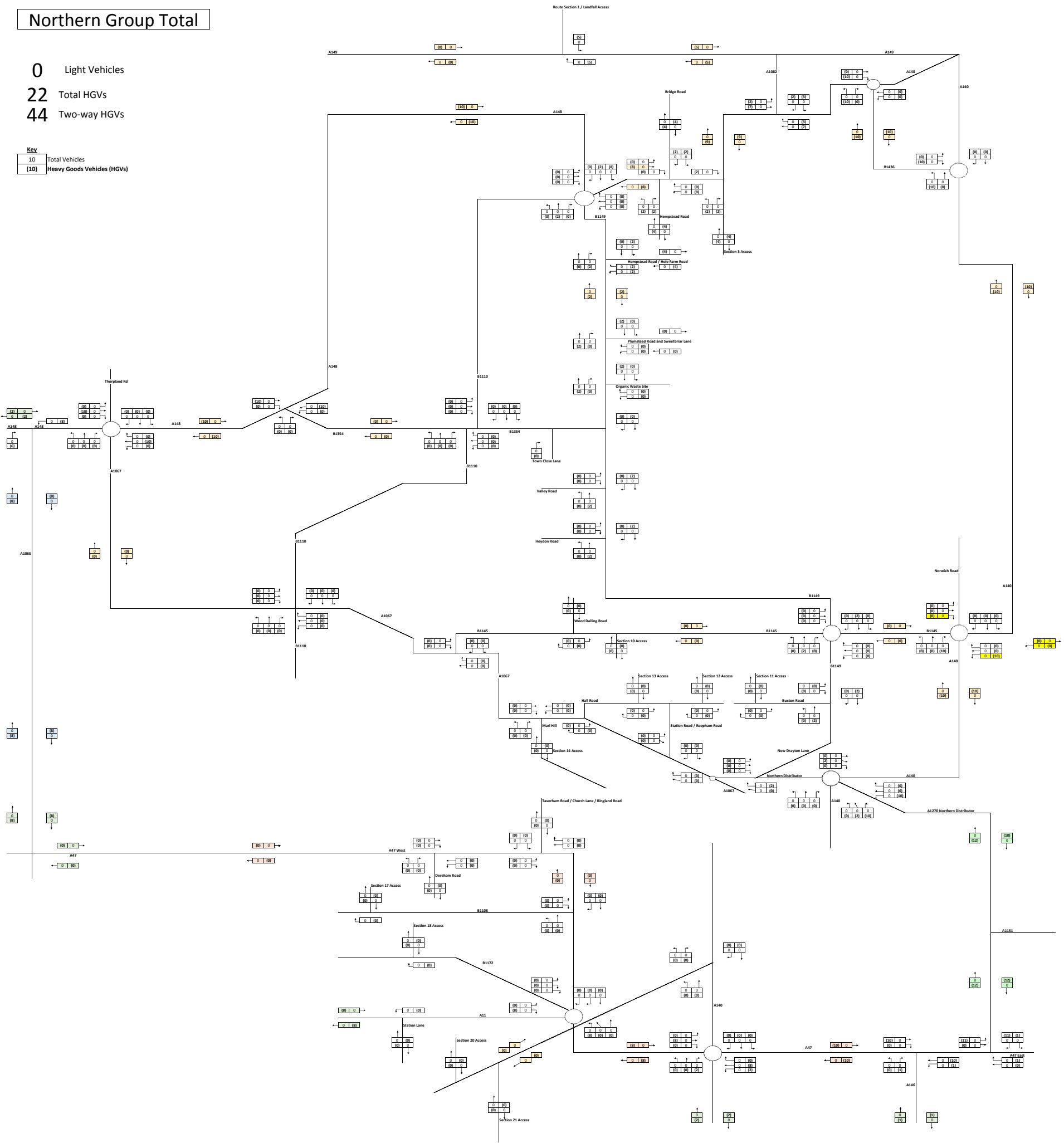

HGVs Assume	10%	from Kings Lynn via A148	Staff Vehicle Movements Assume	8%	via A148
	5%	from Great Yarmouth		28%	via A47 east
	5%	from Lowestoft		11%	from A146
	35%	from A47		7%	from A47 west
	0%	from A1065		6%	from A1065
	35%	from A11		16%	from A11
	30%	from A140 south		13%	from A140 south
	10%	from A140 north		12%	from A140 north
	100%			100%	

- 0 Light Vehicles
- 5 Total HGVs
- 10 Two-Way HGVs

Route Section 6

10	Light Vehicles
10	Heavy Goods Vehicles (HGVs)

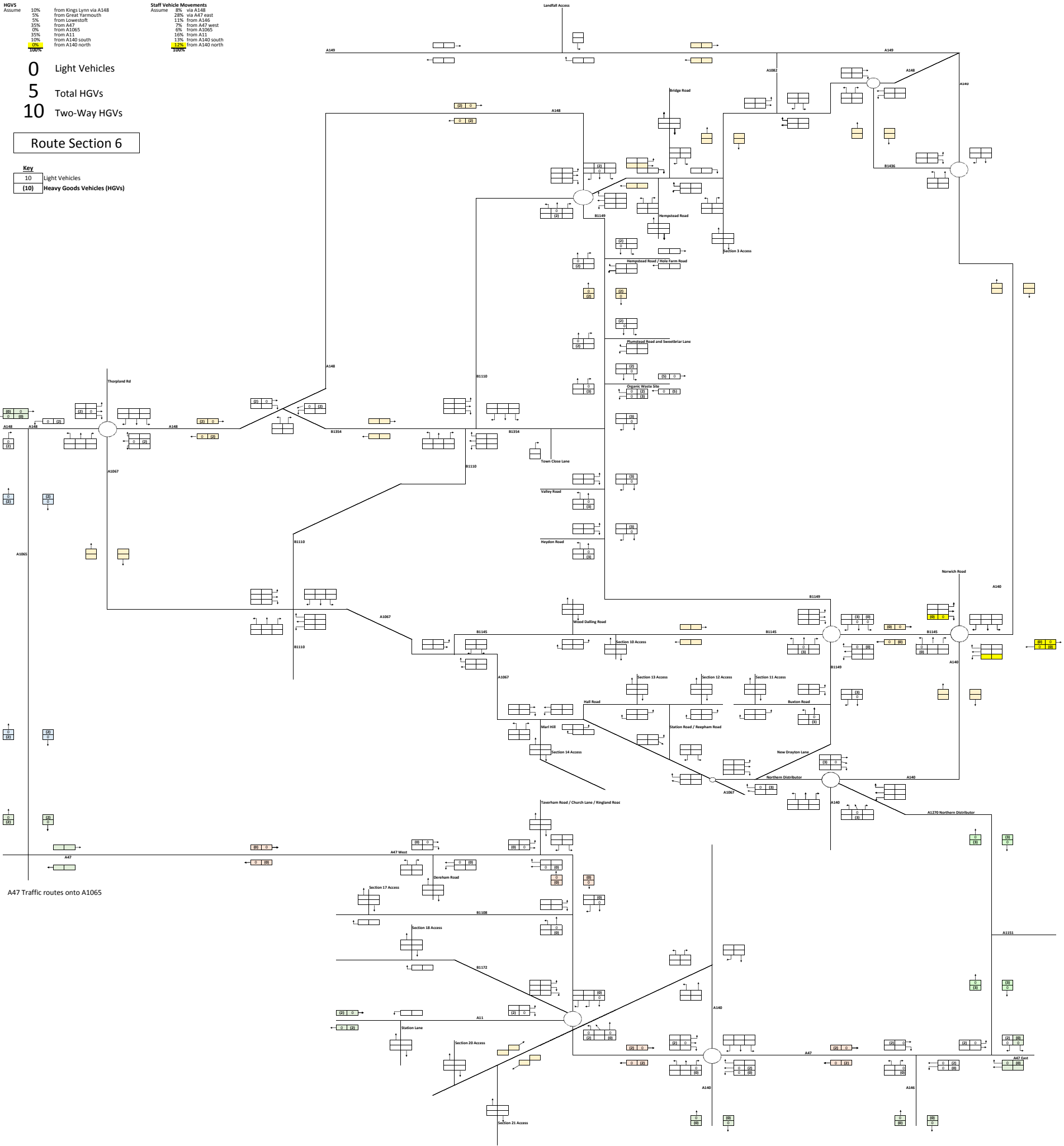

A47 Traffic routes onto A1065

HGVs Assume	10%	from Kings Lynn via A148	Staff Vehicle Movements Assume	8%	via A148
	5%	from Great Yarmouth		28%	via A47 east
	5%	from Lowestoft		11%	from A146
	35%	from A47		7%	from A47 west
	0%	from A1065		6%	from A1065
	35%	from A11		16%	from A11
	10%	from A140 south		13%	from A140 south
	10%	from A140 north		12%	from A140 north
	10%			10%	

- 0 Light Vehicles
- 4 Total HGVs
- 9 Two-Way HGVs

Route Section 8

10	Light Vehicles
10	Heavy Goods Vehicles (HGVs)

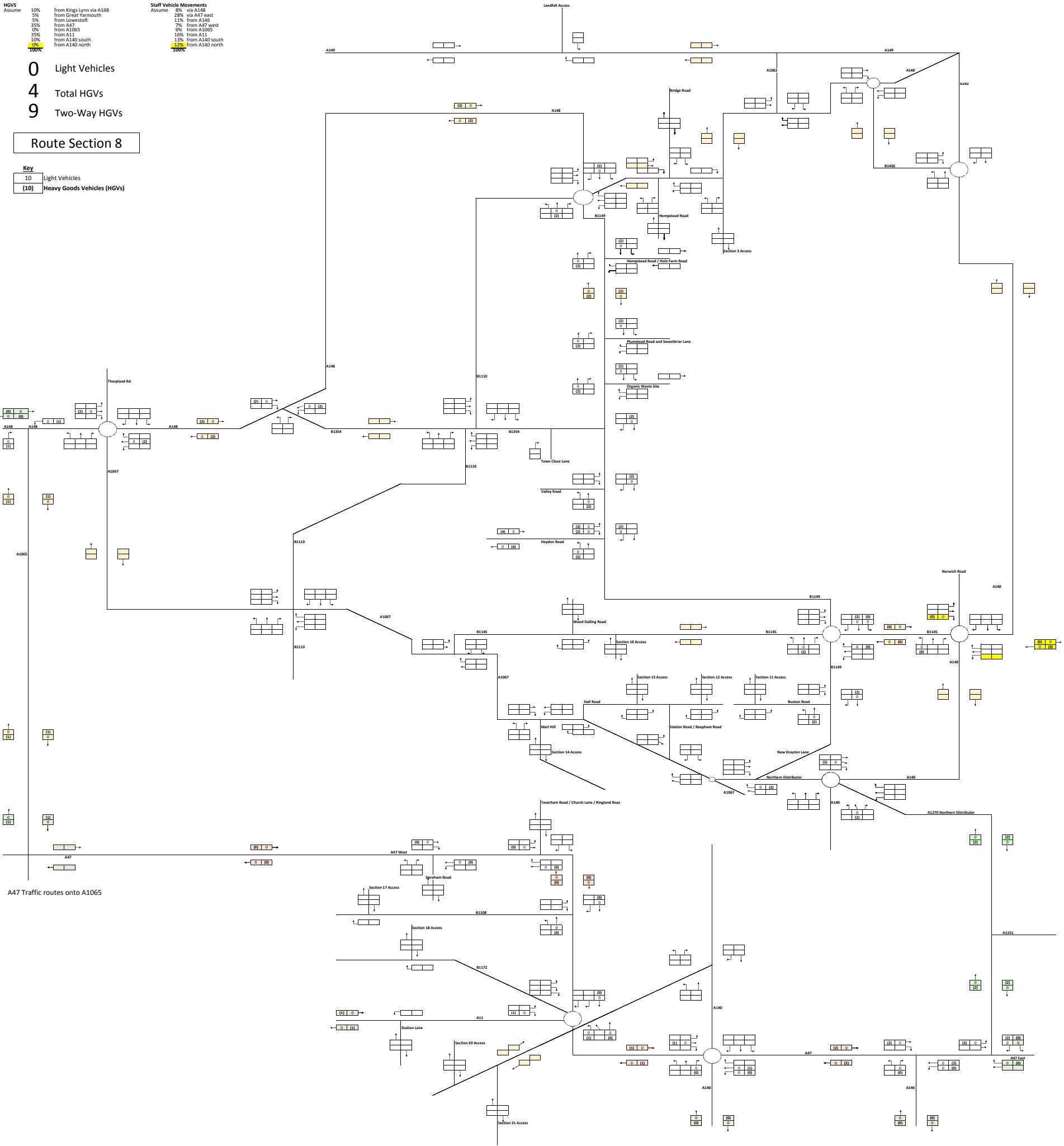

A47 Traffic routes onto A1065

HGVs	10%	from Kings Lynn via A148	Staff Vehicle Movements	8%	via A148
Assume	5%	from Great Yarmouth	28%	via A47 east	
	5%	from Lowestoft	11%	from A146	
	35%	from A47	7%	from A47 west	
	0%	from A1065	6%	from A1065	
	35%	from A11	16%	from A11	
	30%	from A140 south	13%	from A140 south	
	10%	from A140 north	12%	from A140 north	
	100%		100%		

- 0 Light Vehicles
- 4 Total HGVs
- 9 Two-Way HGVs

Route Section 9

10	Light Vehicles
10	Heavy Goods Vehicles (HGVs)

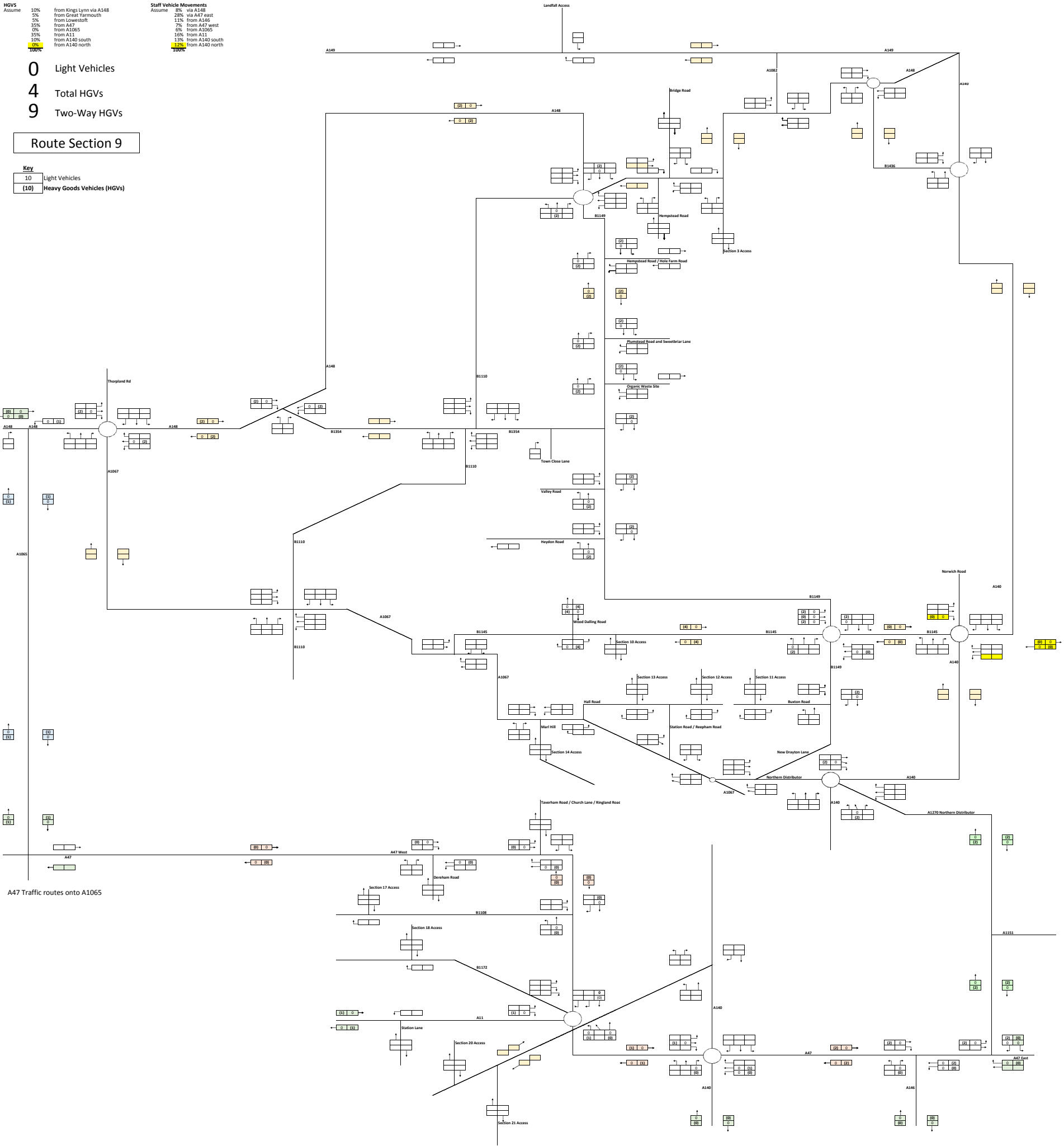

HGVs	10%	from Kings Lynn via A148	Staff Vehicle Movements	8%	via A148
Assume	5%	from Great Yarmouth	28%	via A47 east	
	5%	from Lowestoft	11%	from A146	
	35%	from A47	7%	from A47 west	
	0%	from A1065	6%	from A1065	
	35%	from A11	16%	from A11	
	30%	from A140 south	13%	from A140 south	
	10%	from A140 north	12%	from A140 north	
	100%		100%		

- 0 Light Vehicles
- 4 Total HGVs
- 9 Two-Way HGVs

Route Section 10

10	Light Vehicles
10	Heavy Goods Vehicles (HGVs)

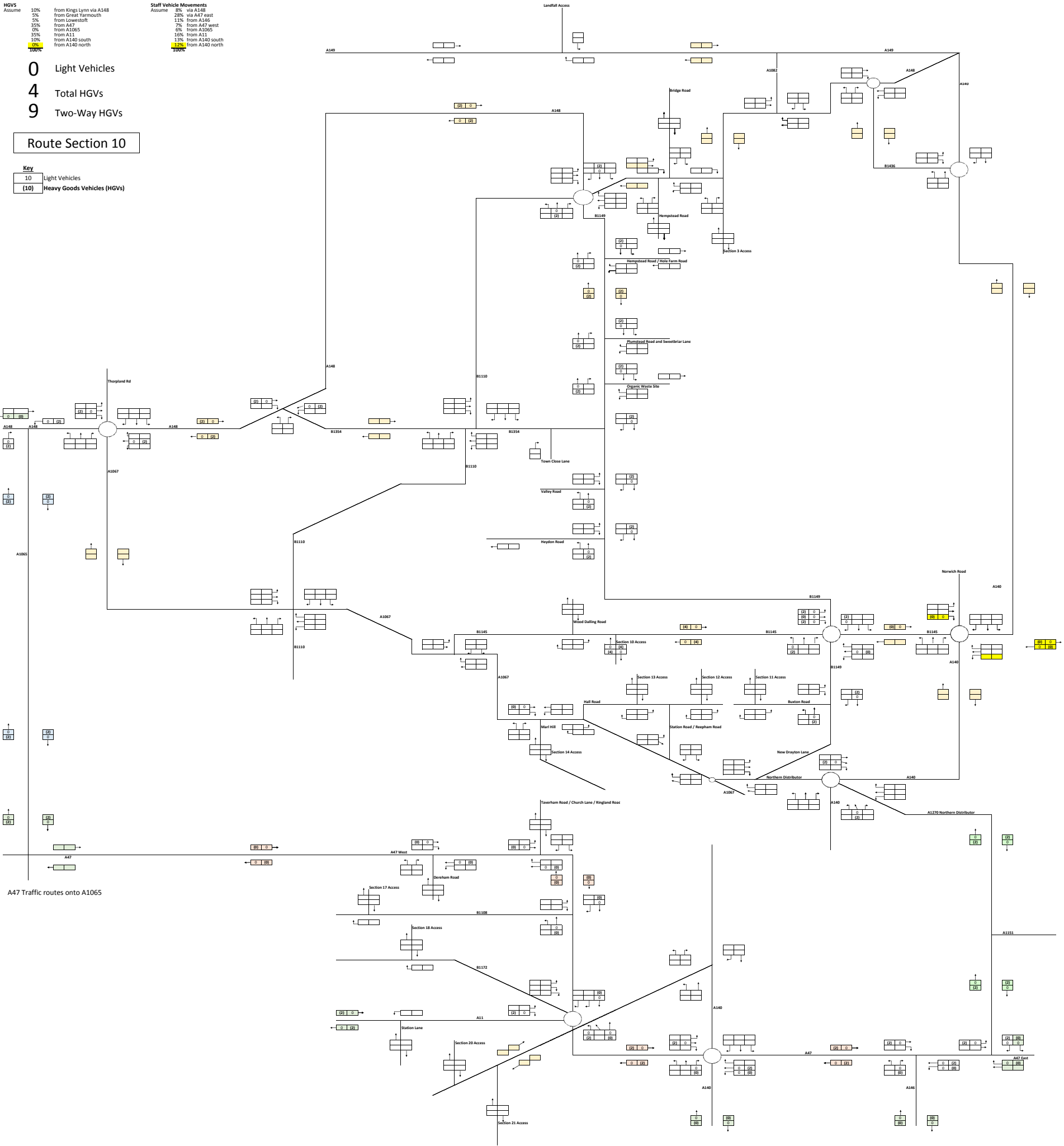

A47 Traffic routes onto A1065

HGVs	10%	from Kings Lynn via A148	Staff Vehicle Movements	8%	via A148
Assume	5%	from Great Yarmouth	28%	via A47 east	
	5%	from Lowestoft	11%	from A146	
	35%	from A47	7%	from A47 west	
	0%	from A1065	6%	from A1065	
	35%	from A11	16%	from A11	
	10%	from A140 south	13%	from A140 south	
	10%	from A140 north	12%	from A140 north	
	10%		10%		

- 0 Light Vehicles
- 4 Total HGVs
- 9 Two-Way HGVs

Route Section 11

10	Light Vehicles
10	Heavy Goods Vehicles (HGVs)

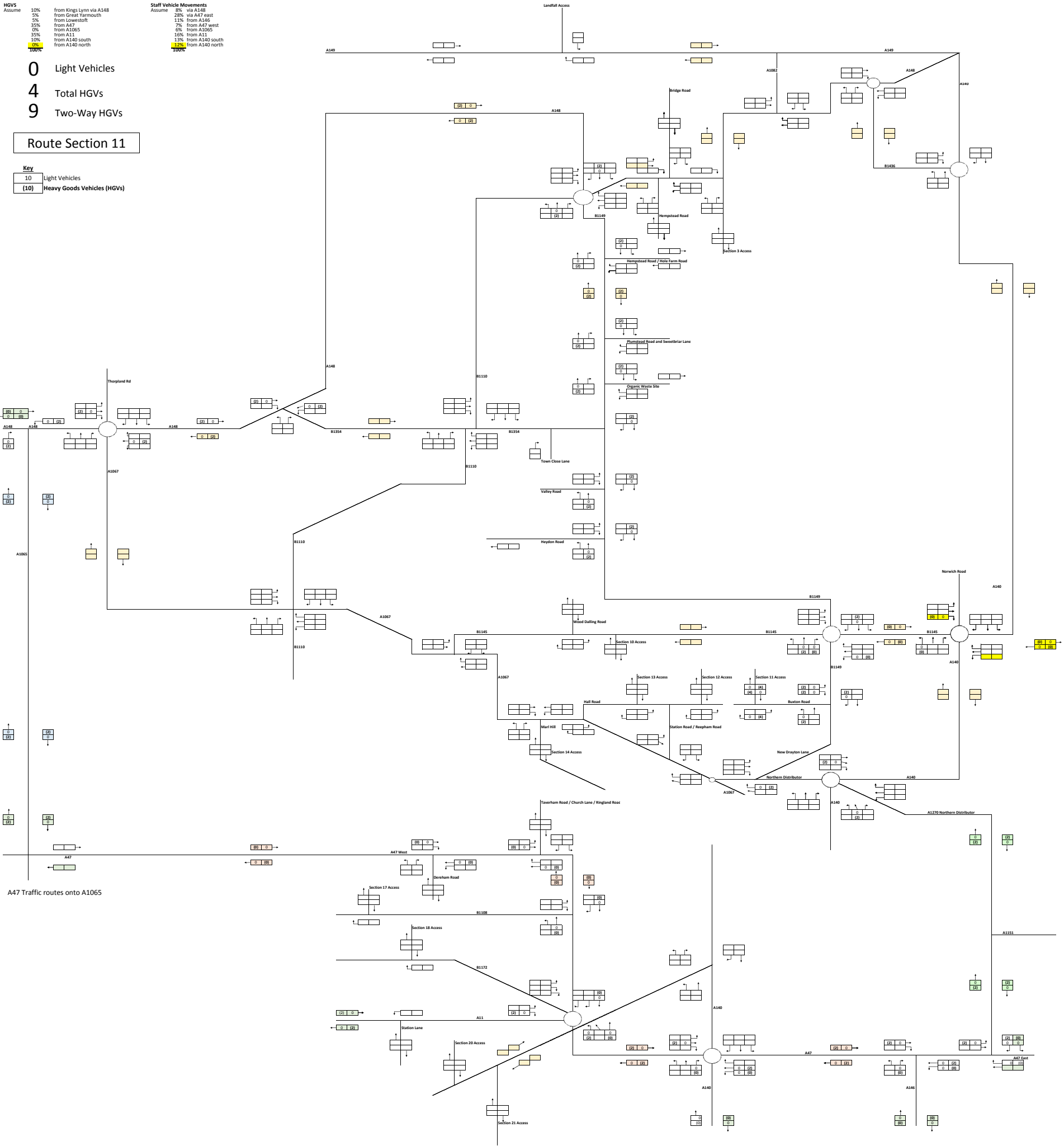

Middle (northern) Group Total

- 0 Light Vehicles
- 22 Total HGVs
- 44 Two-way HGVs

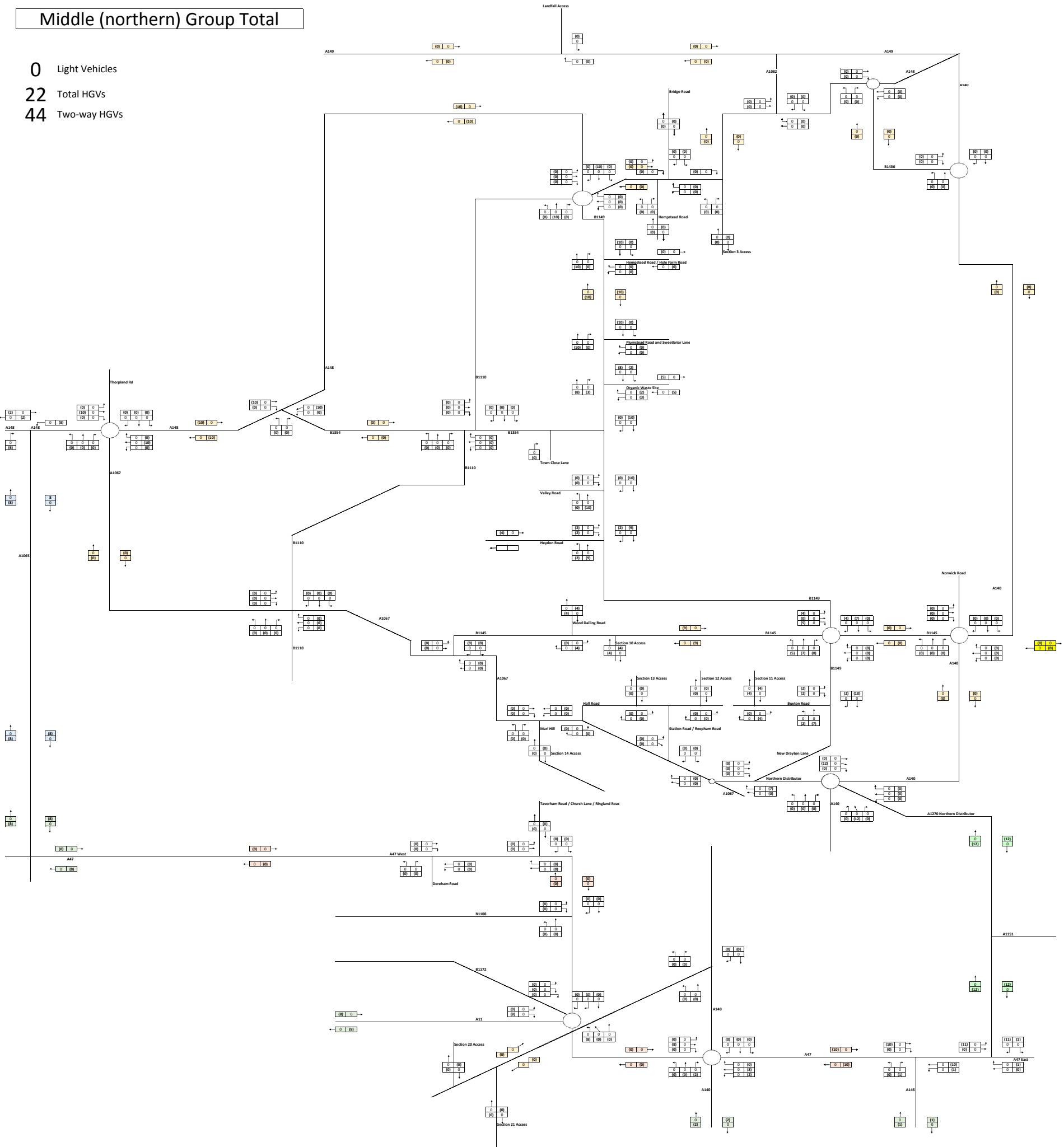

HGVs Assume	10%	from Kings Lynn via A148	Staff Vehicle Movements Assume	8%	via A148
	5%	from Great Yarmouth		28%	via A47 east
	5%	from Lowestoft		11%	from A146
	35%	from A47		7%	from A47 west
	0%	from A1065		6%	from A1065
	35%	from A11		16%	from A11
	10%	from A140 south		13%	from A140 south
	10%	from A140 north		12%	from A140 north
	10%			10%	

- 0 Light Vehicles
- 4 Total HGVs
- 9 Two-Way HGVs

Route Section 12

10	Light Vehicles
10	Heavy Goods Vehicles (HGVs)

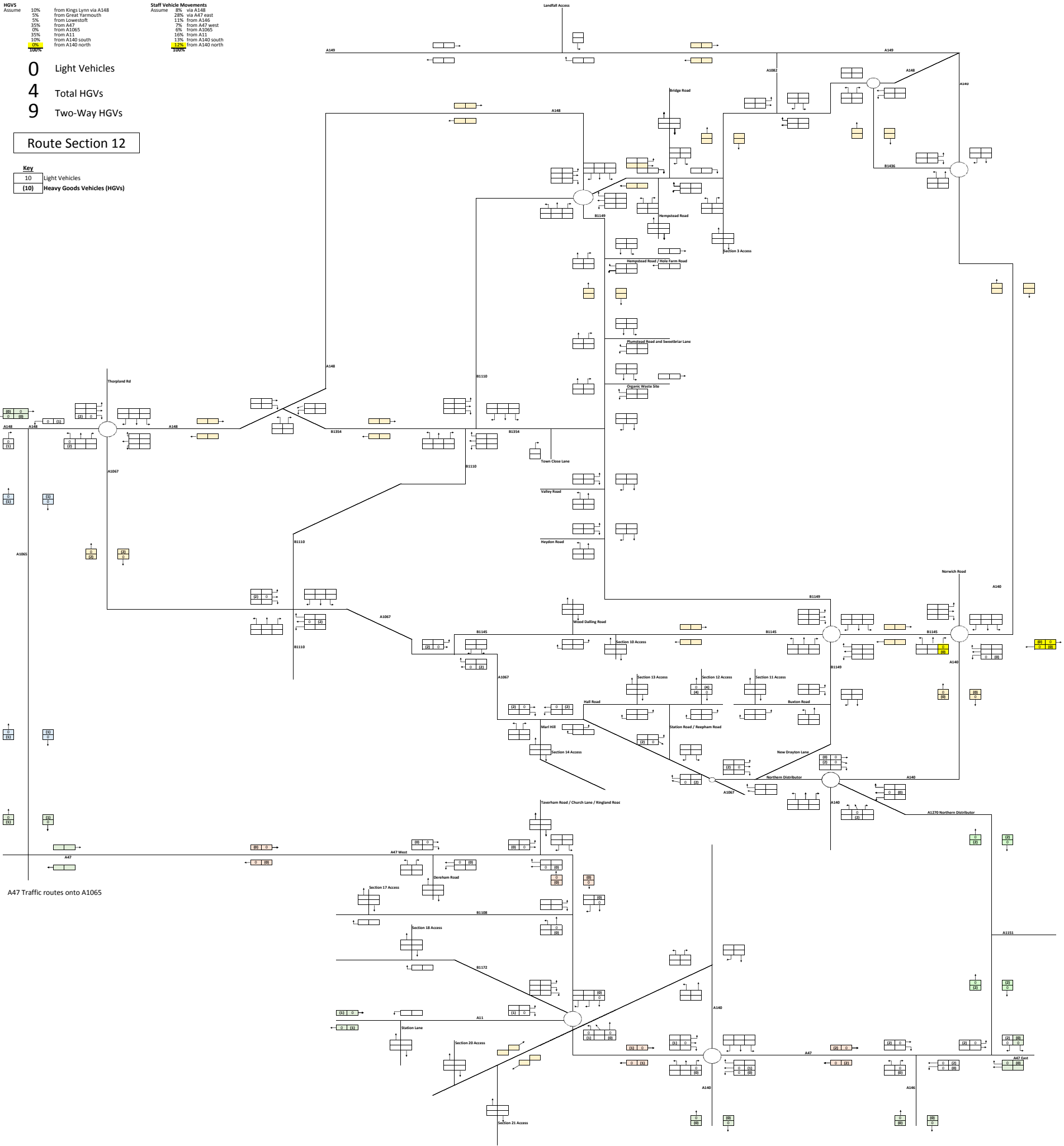

HGVs Assume	10%	from Kings Lynn via A148	Staff Vehicle Movements Assume	8%	via A148
	5%	from Great Yarmouth		28%	via A47 east
	5%	from Lowestoft		11%	from A146
	35%	from A47		7%	from A47 west
	0%	from A1065		6%	from A1065
	35%	from A11		16%	from A11
	10%	from A140 south		13%	from A140 south
	10%	from A140 north		12%	from A140 north
	10%			10%	

- 0 Light Vehicles
- 4 Total HGVs
- 9 Two-Way HGVs

Route Section 13

10	Light Vehicles
10	Heavy Goods Vehicles (HGVs)

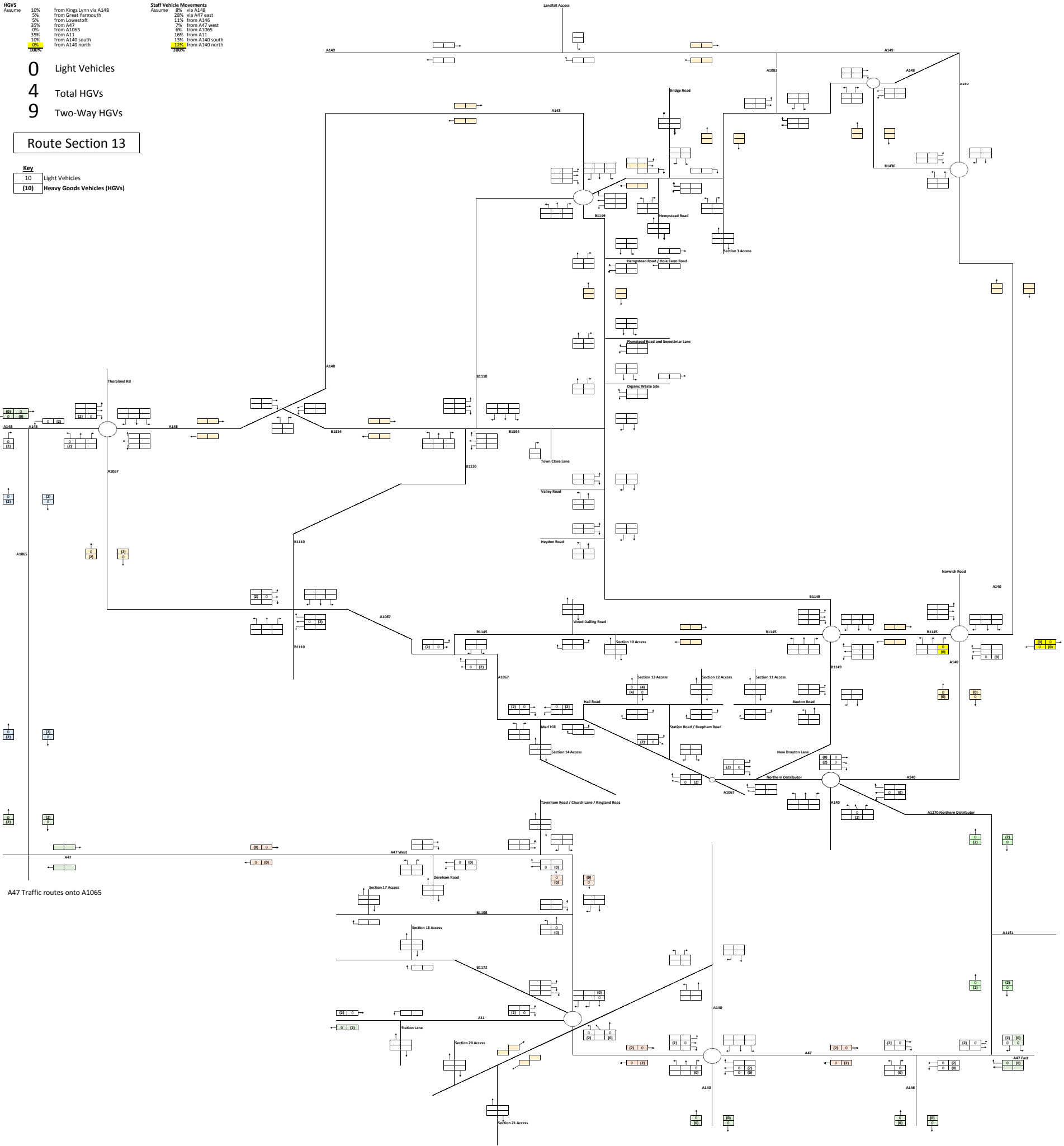

HGVs Assume	10%	from Kings Lynn via A148	Staff Vehicle Movements Assume	8%	via A148
	5%	from Great Yarmouth		28%	via A47 east
	5%	from Lowestoft		11%	from A146
	35%	from A47		7%	from A47 west
	0%	from A1065		6%	from A1065
	35%	from A11		16%	from A11
	10%	from A140 south		13%	from A140 south
	10%	from A140 north		12%	from A140 north
	10%			10%	

- 0** Light Vehicles
- 4** Total HGVs
- 9** Two-Way HGVs

Route Section 14

Key	
10	Light Vehicles
10	Heavy Goods Vehicles (HGVs)

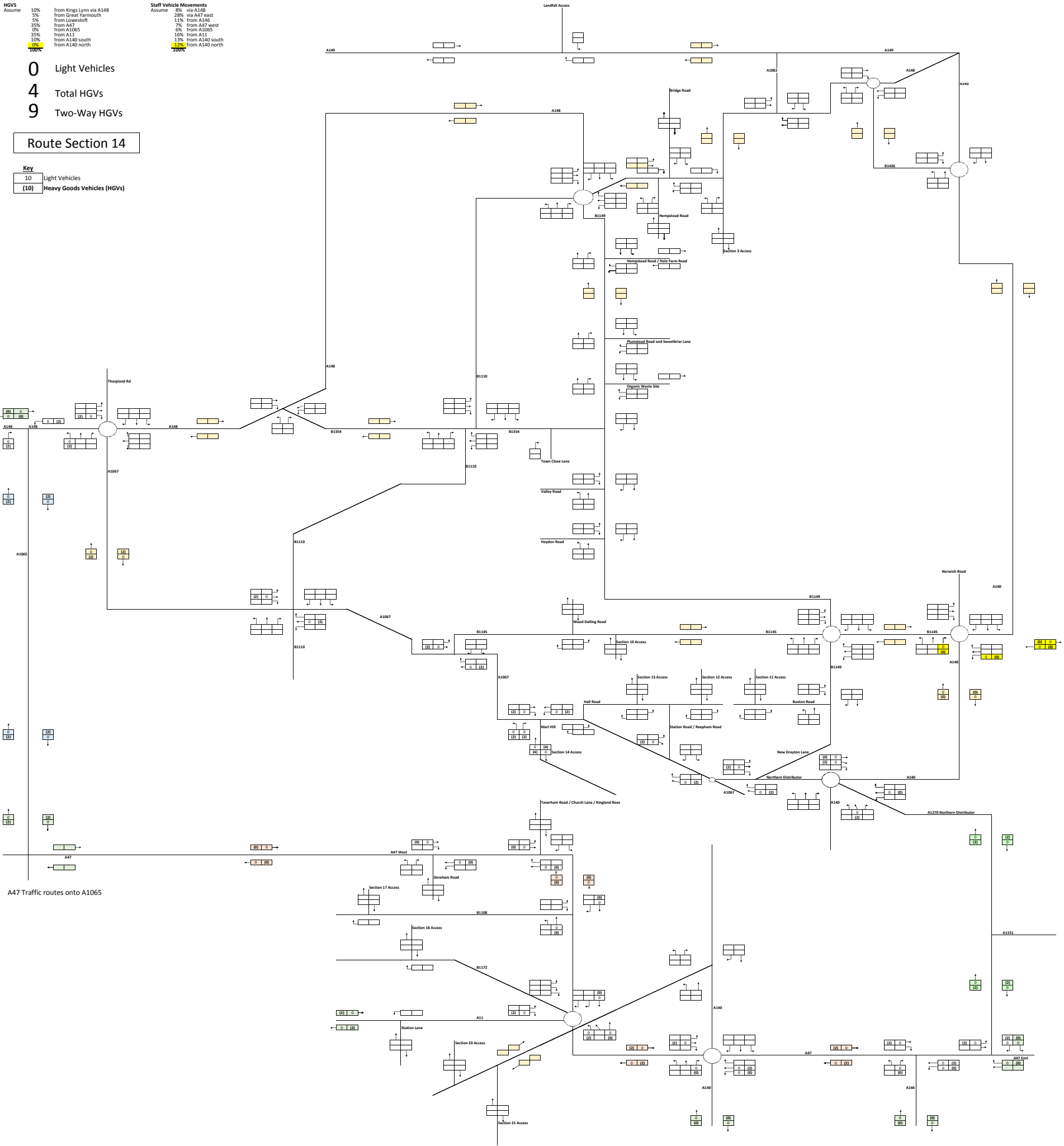

HGVs		Staff Vehicle Movements	
Assume	10%	Assume	30%
	from Kings Lynn via A47		via A148
	5%		28% via A47 east
	from Great Yarmouth		11% from A146
	5%		7% from A47 west
	from Lowestoft		6% from A1065
	35%		10% from A11
	from A47 via A47		3% from A140 south
	0%		12% from A140 north
	35%		10% from A11
	from A1065 via A47		1%
	10%		1%
	from A140 south		1%
	10%		1%
	from A140 north		1%
	10%		1%
	from A140 north		1%
	10%		1%
	from A140 north		1%
	10%		1%
	from A140 north		1%
	10%		1%

- 0 Light Vehicles
- 4 Total HGVs
- 9 Two-Way HGVs

Route Section 15

Key	
10	Light Vehicles
10	Heavy Goods Vehicles (HGVs)

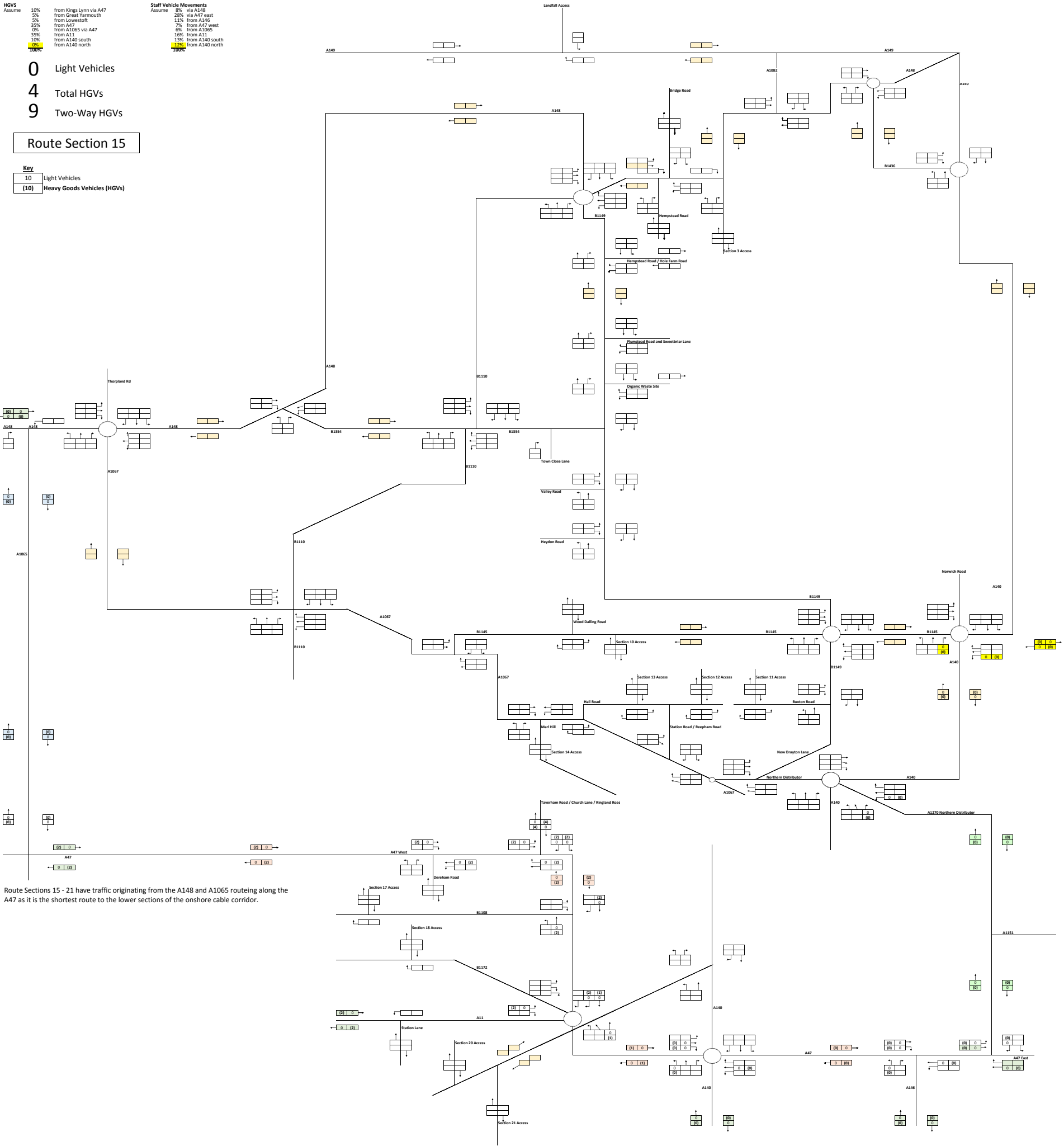

Route Sections 15 - 21 have traffic originating from the A148 and A1065 routing along the A47 as it is the shortest route to the lower sections of the onshore cable corridor.

HGVs	10%	from Kings Lynn via A47	Staff Vehicle Movements	8%	via A148
Assume	5%	from Great Yarmouth	28%	via A47 east	
	5%	from Lowestoft	11%	from A146	
	35%	from A47	7%	from A47 west	
	0%	from A1065 via A47	6%	from A1065	
	35%	from A11	16%	from A11	
	30%	from A140 south	13%	from A140 south	
	0%	from A140 north	12%	from A140 north	
	100%		100%		

- 0 Light Vehicles
- 4 Total HGVs
- 9 Two-Way HGVs

Route Section 16

10	Light Vehicles
10	Heavy Goods Vehicles (HGVs)

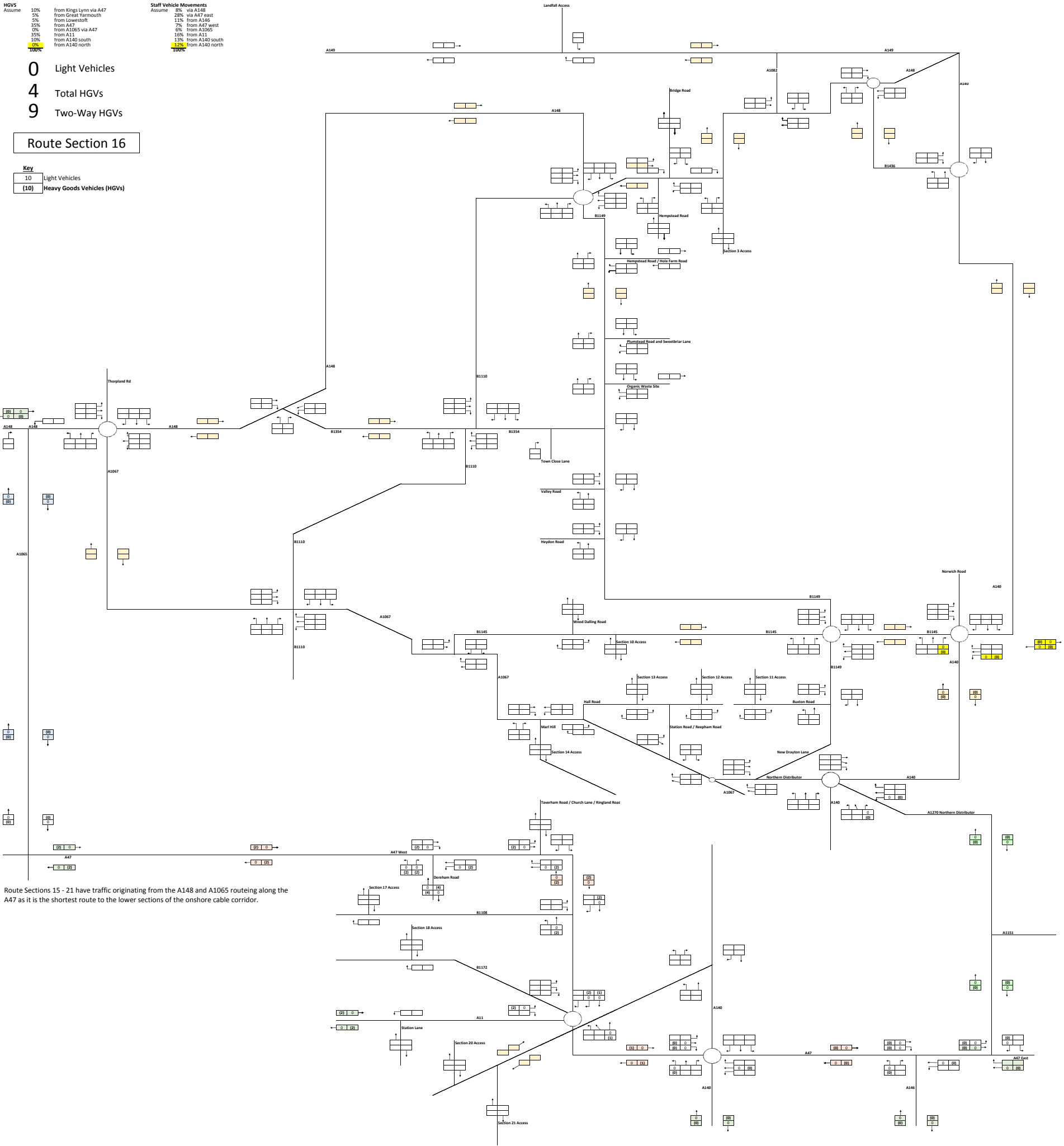

Route Sections 15 - 21 have traffic originating from the A148 and A1065 routing along the A47 as it is the shortest route to the lower sections of the onshore cable corridor.

Middle (southern) Group Total

0 Light Vehicles
22 Total HGVs
44 Total HGVs

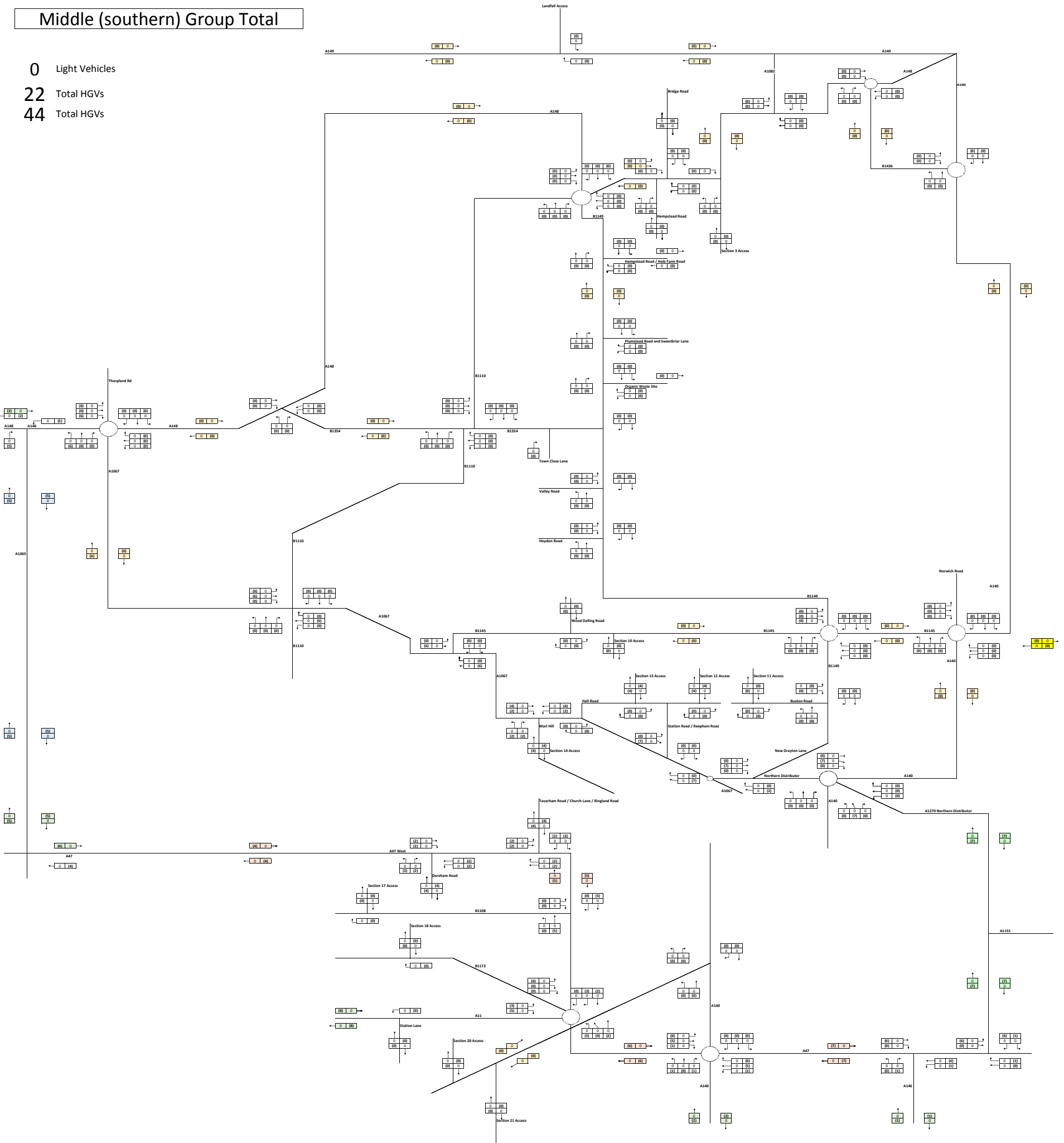

HGVs	Assume	10%	from Kings Lynn via A47	Staff Vehicle Movements	Assume	8%	via A148
		5%	from Great Yarmouth			28%	via A47 east
		5%	from Lowestoft			11%	from A146
		35%	from A47			7%	from A47 west
		0%	from A1065 via A47			6%	from A1065
		35%	from A11			16%	from A11
		30%	from A140 south			3%	from A140 south
		10%	from A140 north			12%	from A140 north
		10%	from A140 north			10%	from A140 north

- 0 Light Vehicles
- 4 Total HGVs
- 9 Two-Way HGVs

Route Section 17

10	Light Vehicles
10	Heavy Goods Vehicles (HGVs)

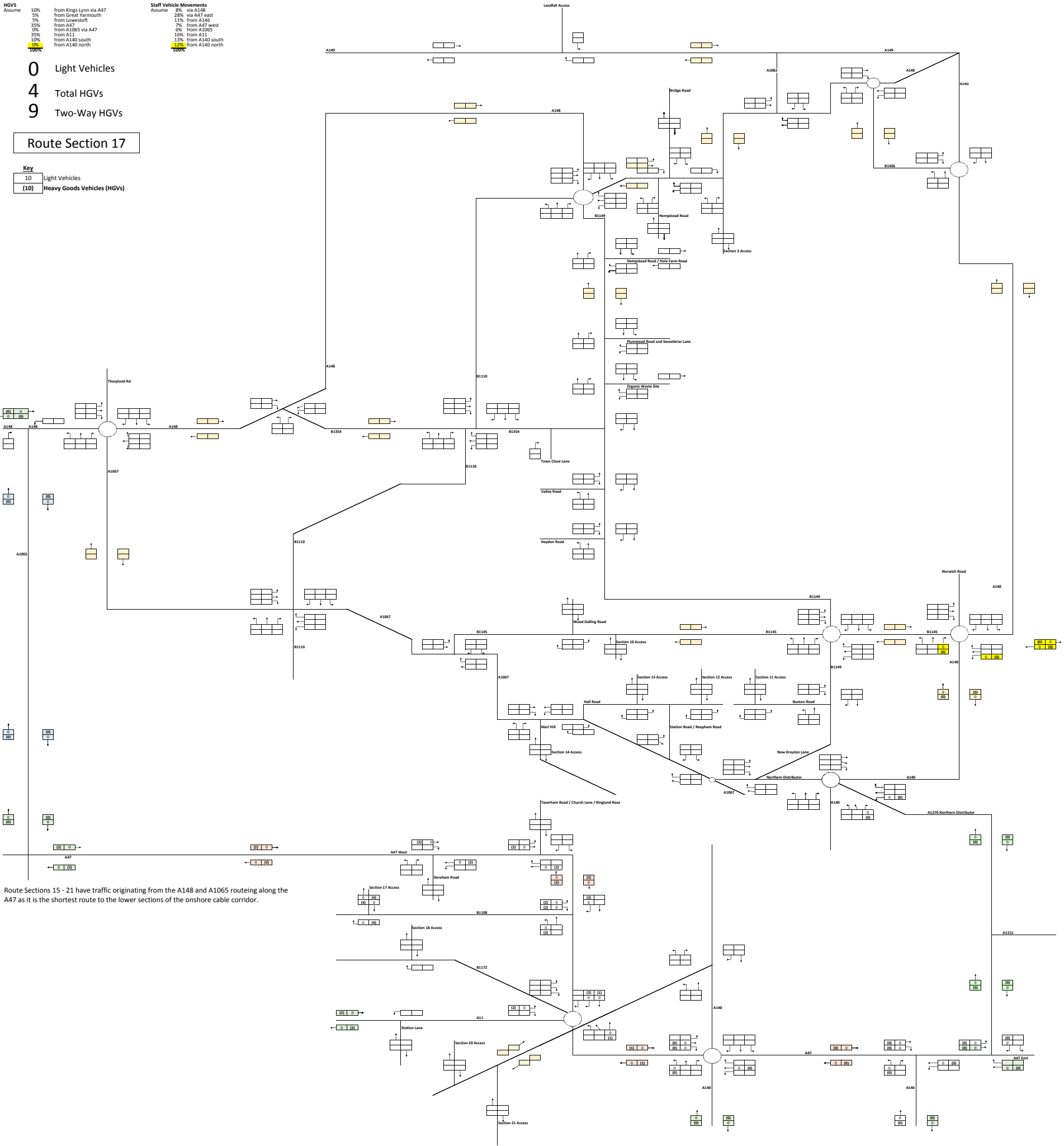

Route Sections 15 - 21 have traffic originating from the A148 and A1065 routing along the A47 as it is the shortest route to the lower sections of the onshore cable corridor.

HGVs Assume	10%	from Kings Lynn via A47	Staff Vehicle Movements Assume	28%	via A148
	5%	from Great Yarmouth		11%	from A146
	5%	from Lowestoft		7%	from A47 west
	35%	from A47		6%	from A1065
	0%	from A1065 via A47		10%	from A11
	35%	from A11		13%	from A140 south
	30%	from A140 south		12%	from A140 north
	10%	from A140 north		12%	from A140 north
					12%

- 0 Light Vehicles
- 4 Total HGVs
- 9 Two-Way HGVs

Route Section 18

10	Light Vehicles
10	Heavy Goods Vehicles (HGVs)

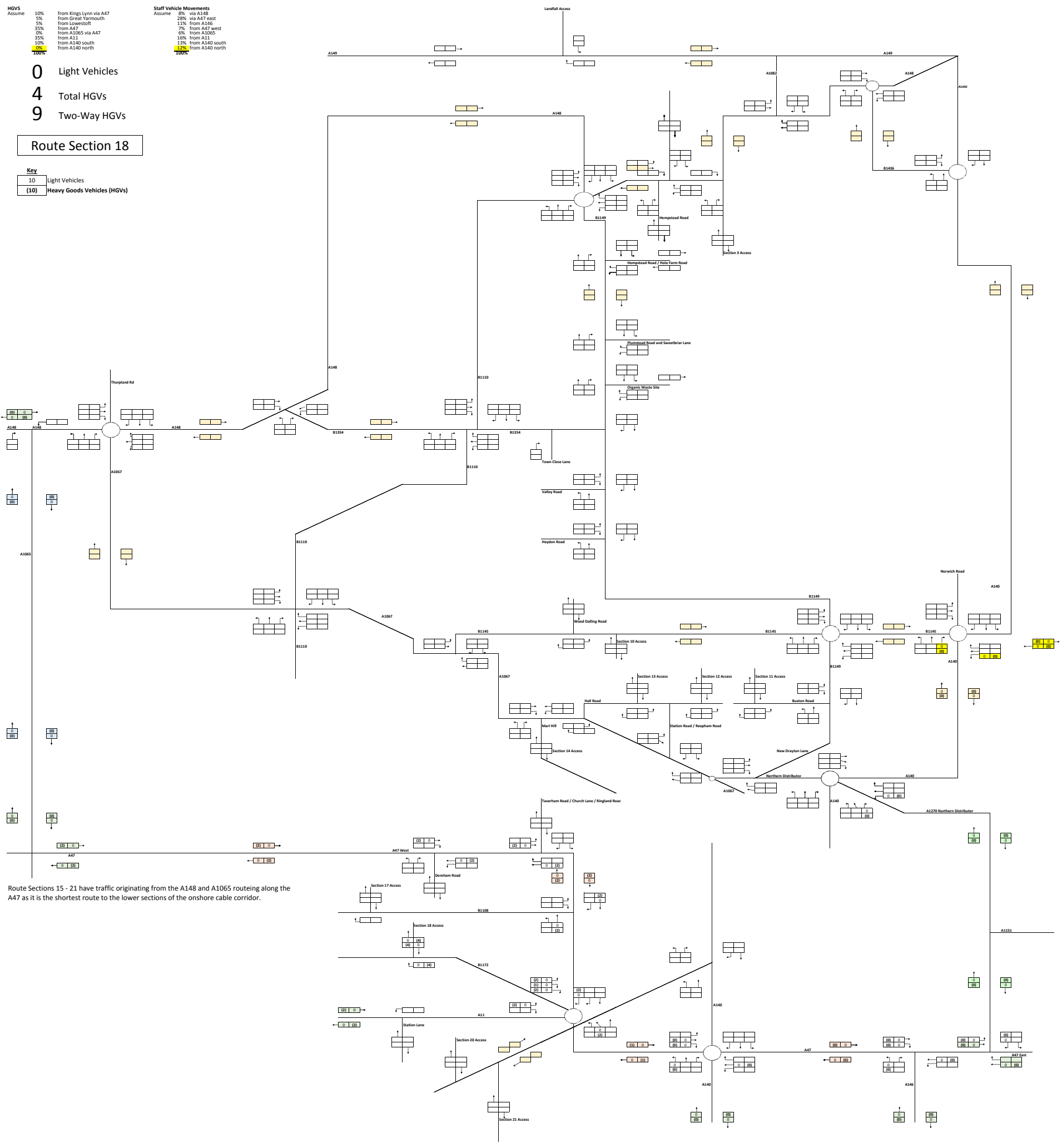

Route Sections 15 - 21 have traffic originating from the A148 and A1065 routing along the A47 as it is the shortest route to the lower sections of the onshore cable corridor.

HGVs		Staff Vehicle Movements	
Assume	10%	Assume	30%
	from Kings Lynn via A47		via A148
	5%		28%
	from Great Yarmouth		via A47 east
	5%		11%
	from Lowestoft		from A146
	35%		7%
	from A47		from A47 west
	0%		6%
	from A1065 via A47		from A1065
	35%		10%
	from A11		3%
	30%		from A140 south
	from A140 south		12%
	from A140 north		from A140 north
	10%		10%

- 0 Light Vehicles
- 4 Total HGVs
- 9 Two-Way HGVs

Route Section 19

Key	
10	Light Vehicles
10	Heavy Goods Vehicles (HGVs)

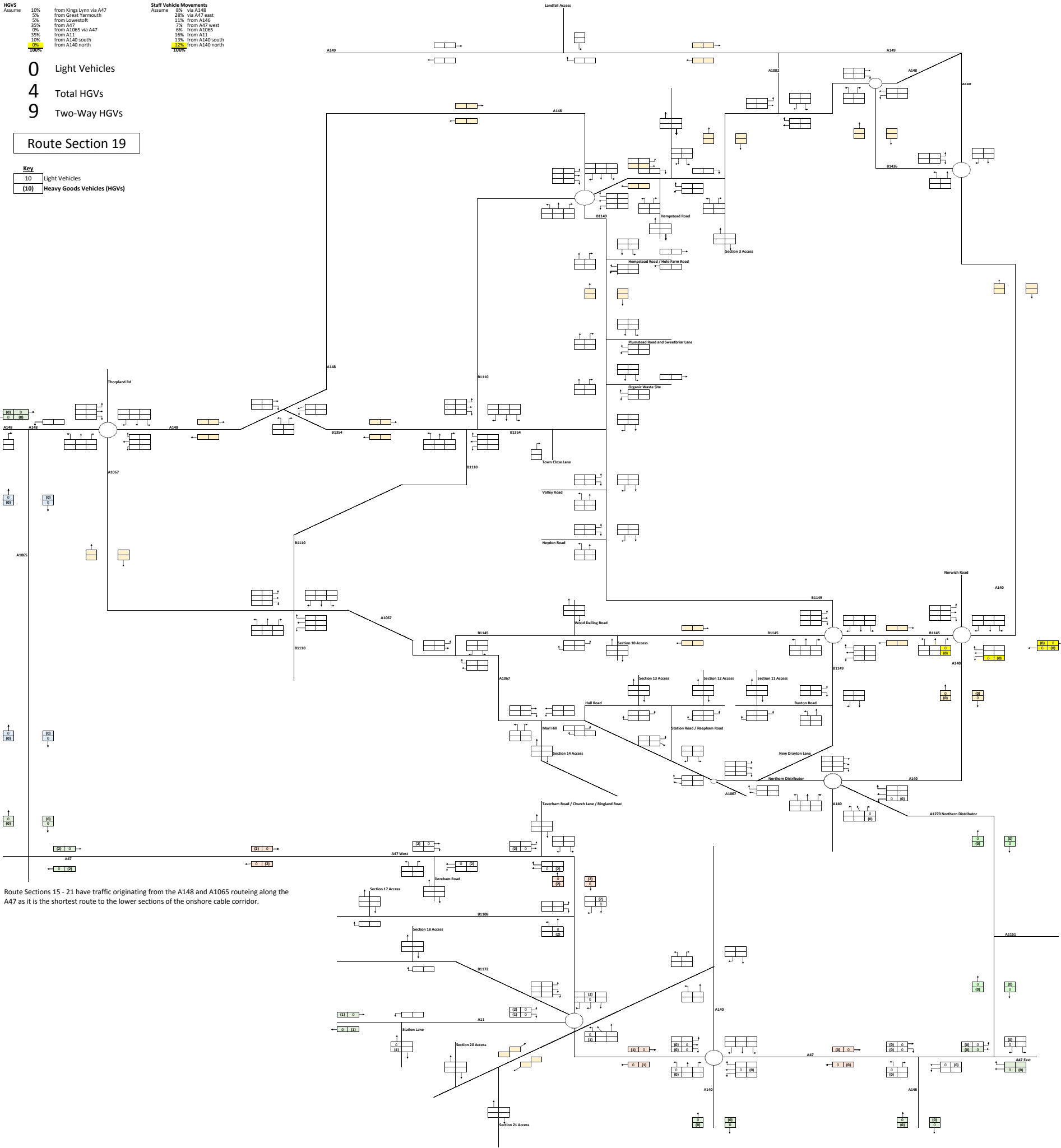

Route Sections 15 - 21 have traffic originating from the A148 and A1065 routing along the A47 as it is the shortest route to the lower sections of the onshore cable corridor.

HGVs	10%	from Kings Lynn via A47	Staff Vehicle Movements	28%	via A148
Assume	5%	from Great Yarmouth	Assume	11%	from A146
	5%	from Lowestoft		7%	from A47 west
	35%	from A47		6%	from A1065
	0%	from A1065 via A47		10%	from A11
	35%	from A11		13%	from A140 south
	30%	from A140 south		12%	from A140 north
	10%	from A140 north		12%	from A140 north
	10%			12%	

- 0 Light Vehicles
- 4 Total HGVs
- 9 Two-Way HGVs

Route Section 20

10	Light Vehicles
10	Heavy Goods Vehicles (HGVs)

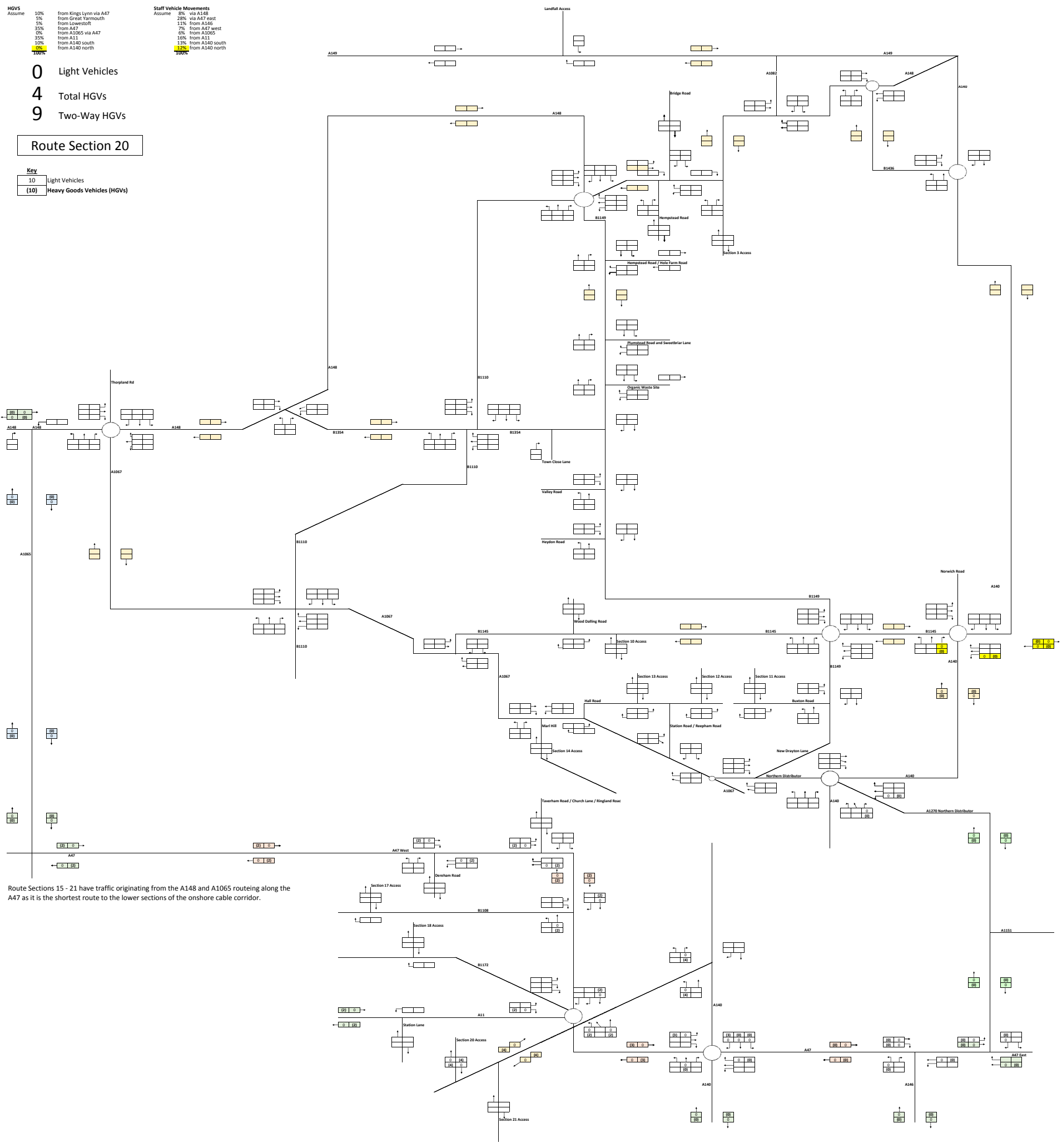



Route Sections 15 - 21 have traffic originating from the A148 and A1065 routing along the A47 as it is the shortest route to the lower sections of the onshore cable corridor.

Southern Group Total

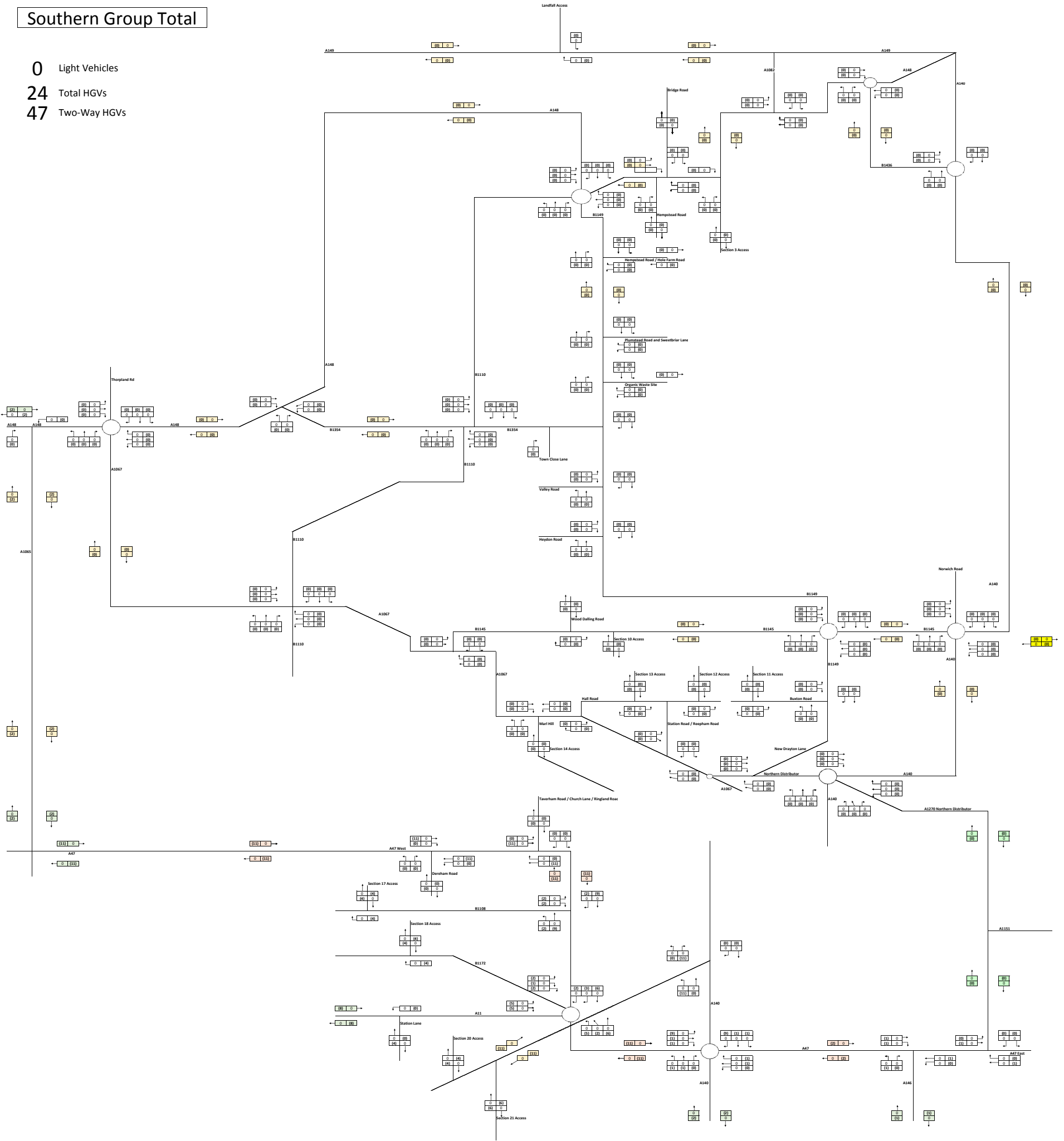

- 0 Light Vehicles
- 24 Total HGVs
- 47 Two-Way HGVs



HGVs		Staff Vehicle Movements	
Assume	10%	Assume	8%
	from Kings Lynn via A148		via A148
	5%		28% via A47 east
	from Great Yarmouth		11% from A146
	5%		7% from A47 west
	from Lowestoft		6% from A105
	35%		10% from A11
	from A47		13% from A140 south
	0%		12% from A140 north
	from A105		
	35%		
	from A11		
	10%		
	from A140 south		
	30%		
	from A140 north		
	10%		
	from A140 north		
	10%		

-  Light Vehicles
-  Total HGVs
-  Two-Way HGVs

Landfall

Key	
	Light Vehicles
	Heavy Goods Vehicles (HGVs)

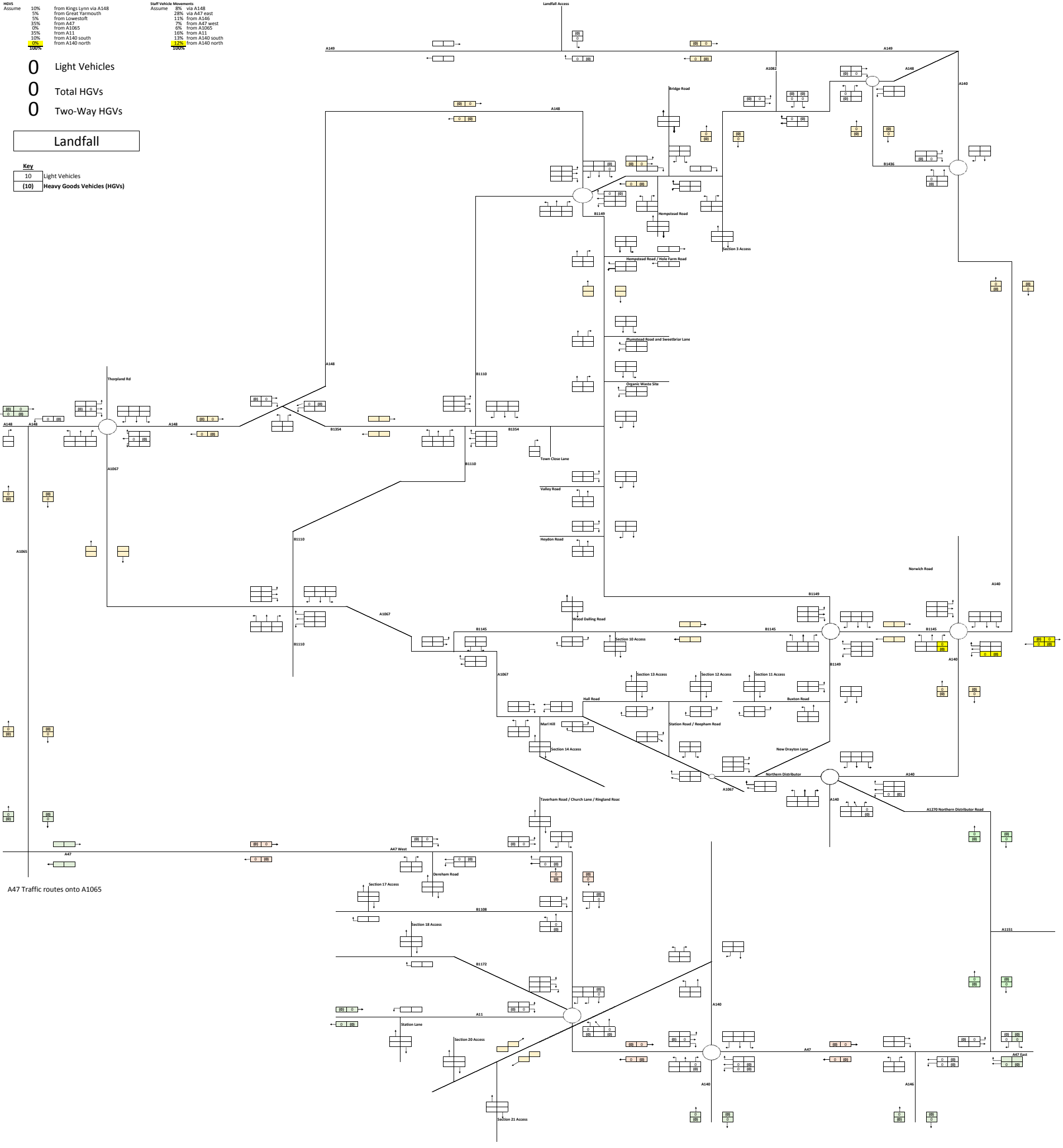

A47 Traffic routes onto A1065

HGVs	10%	from Kings Lynn via A148
Assume	5%	from Great Yarmouth
	5%	from Lowestoft
	35%	from A47
	0%	from A1065
	35%	from A11
	30%	from A140 south
	10%	from A140 north
	100%	

Staff Vehicle Movements	8%	via A148
Assume	28%	via A47 east
	11%	from A146
	7%	from A47 west
	6%	from A1065
	16%	from A11
	13%	from A140 south
	12%	from A140 north
	100%	

- 0 Light Vehicles
- 1 Total HGVs
- 1 Two-Way HGVs

HVAC Booster Station

10	Light Vehicles
10	Heavy Goods Vehicles (HGVs)

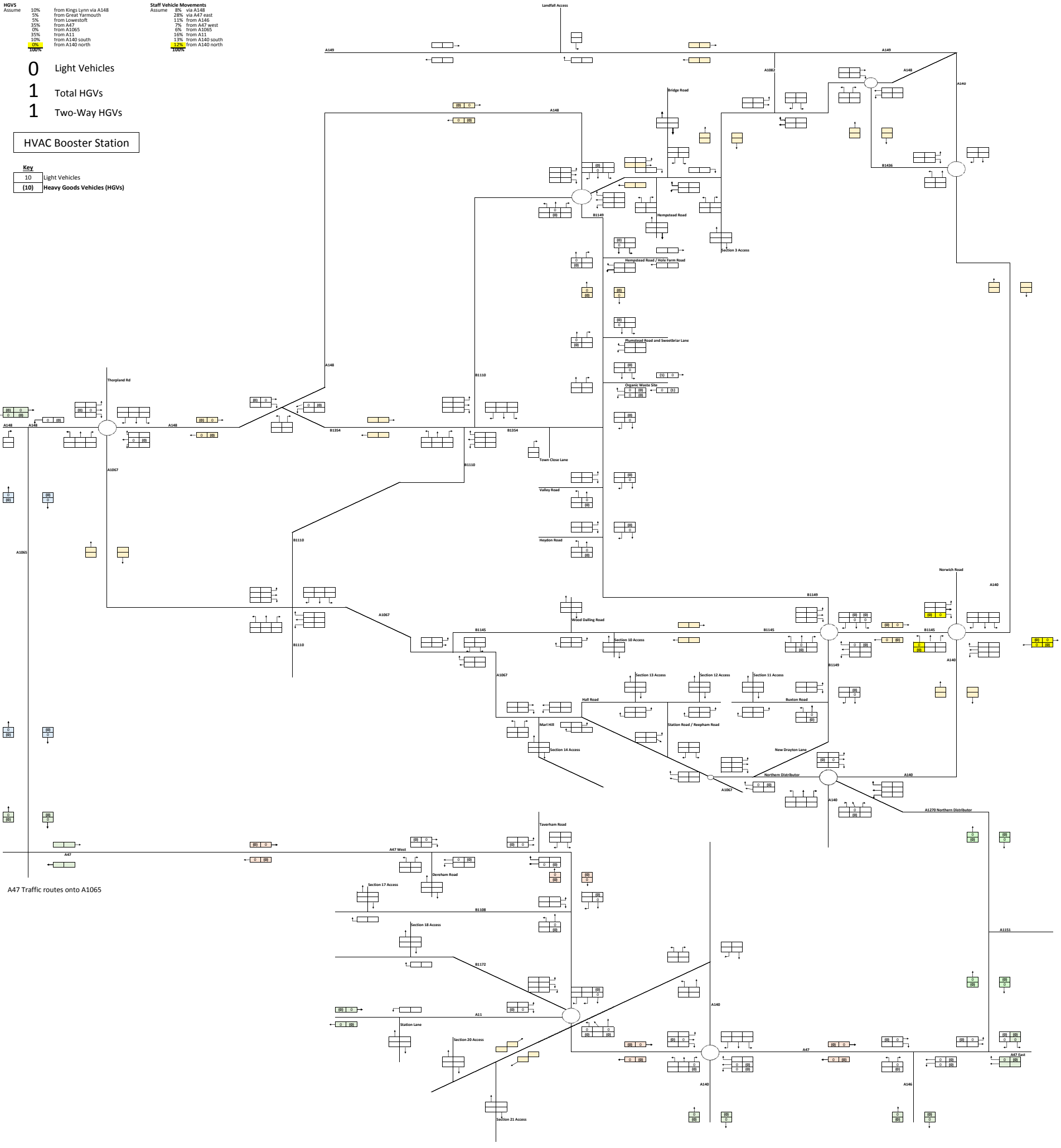

A47 Traffic routes onto A1065

HGVs		Staff Vehicle Movements	
Assume	10%	Assume	8%
	from Kings Lynn via A47		via A148
	5%		28% via A47 east
	from Great Yarmouth		11% from A146
	5%		7% from A47 west
	35% from A47		6% from A105
	0% from A105 via A47		16% from A11
	35% from A11		13% from A140 south
	10% from A140 south		12% from A140 north
	100%		100%

- 0** Light Vehicles
- 1** Total HGVs
- 3** Two-Way HGVs

HVAC Substation

10	Light Vehicles
10	Heavy Goods Vehicles (HGVs)

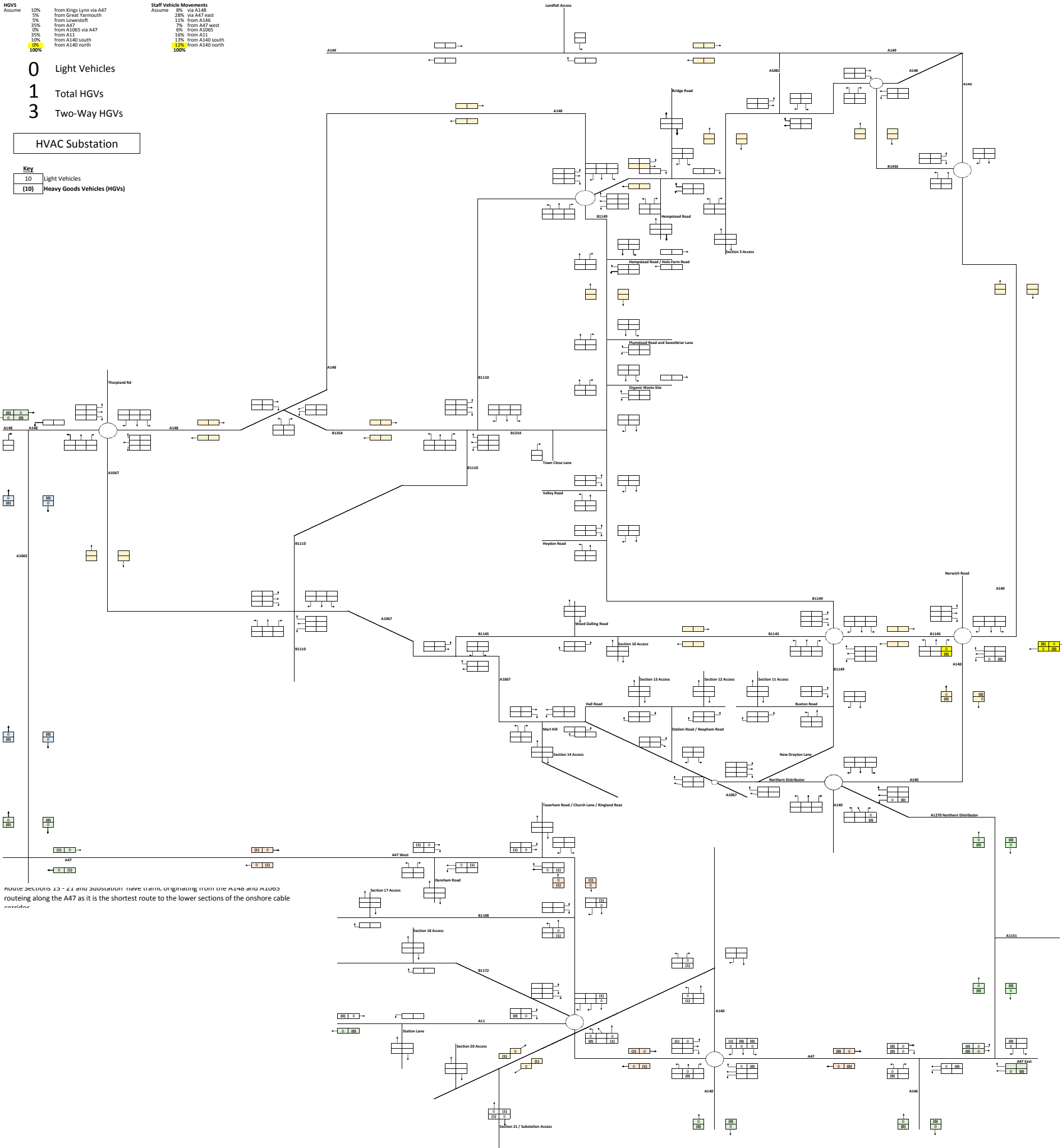

routing along the A47 as it is the shortest route to the lower sections of the onshore cable

Hourly Construction HGV Flows
Northern Group + Landfill + Booster Station + Substation

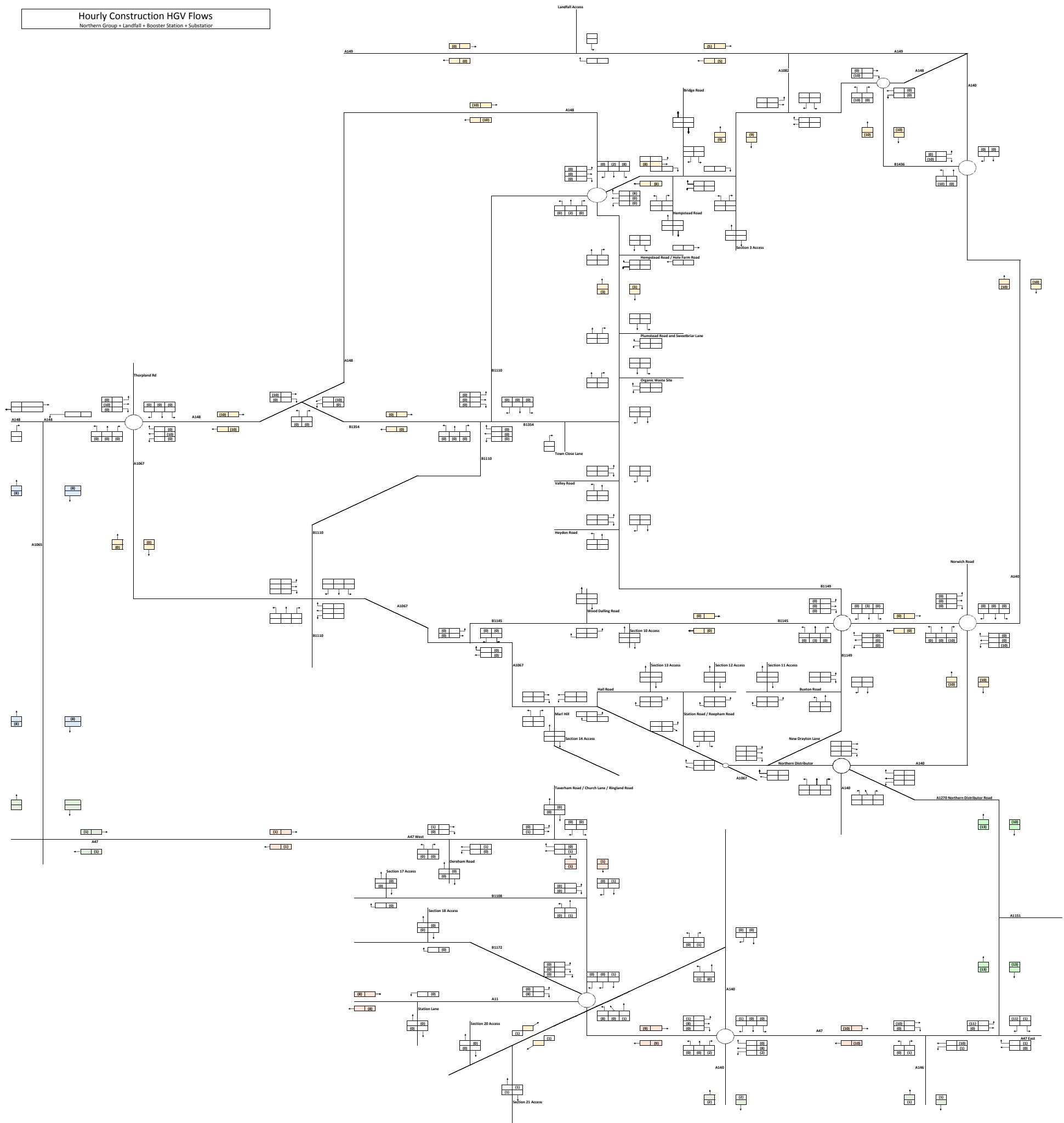

Hourly Construction HGV Flows
Middle (northern) Group + Landfill + Booster Station + Substation

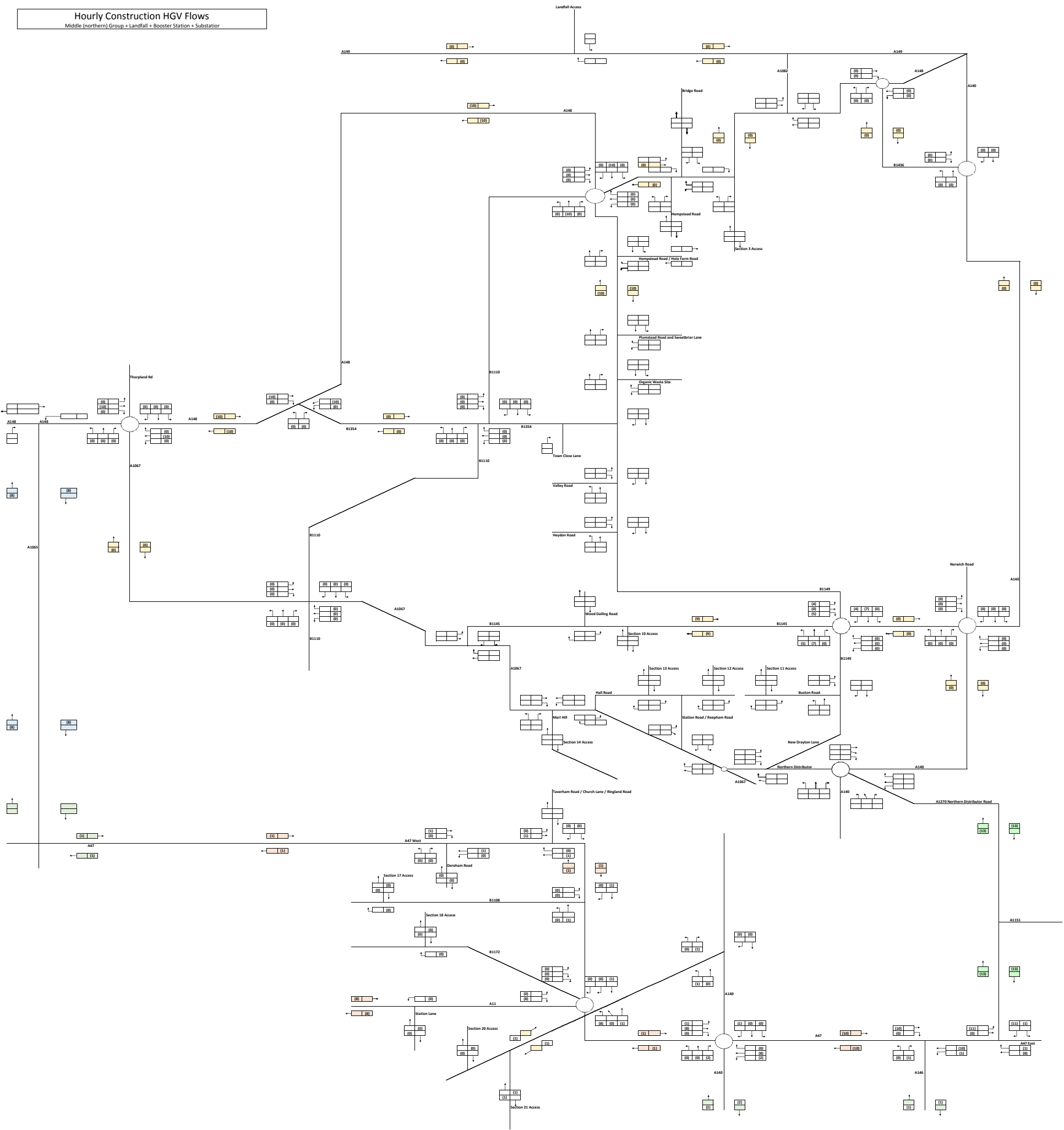

Hourly Construction HGV Flows
Middle (southern) Group + Landfill + Booster Station + Substation

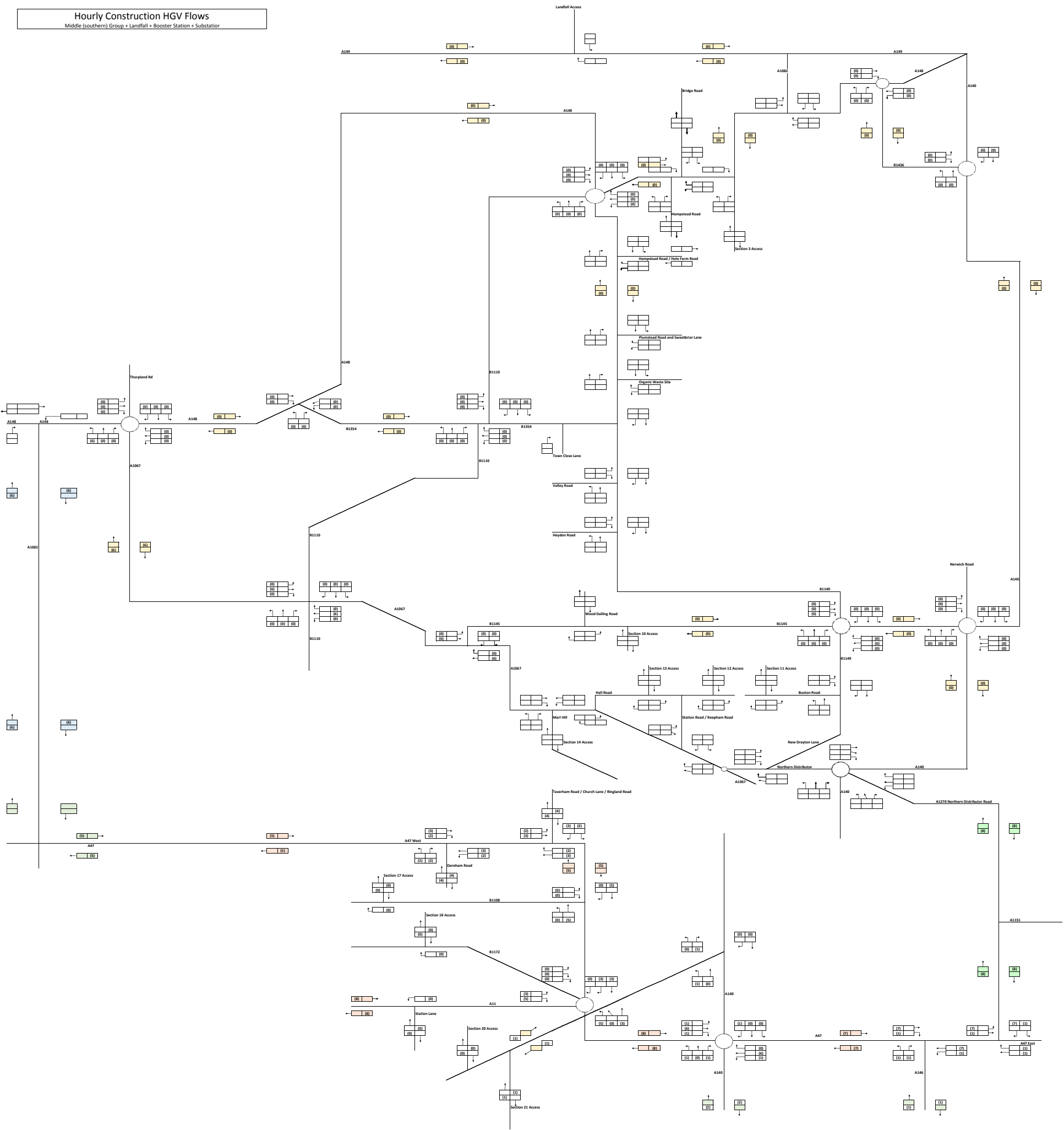

Hourly Construction HGV Flows
Southern Group + Landfill + Booster Station + Substation

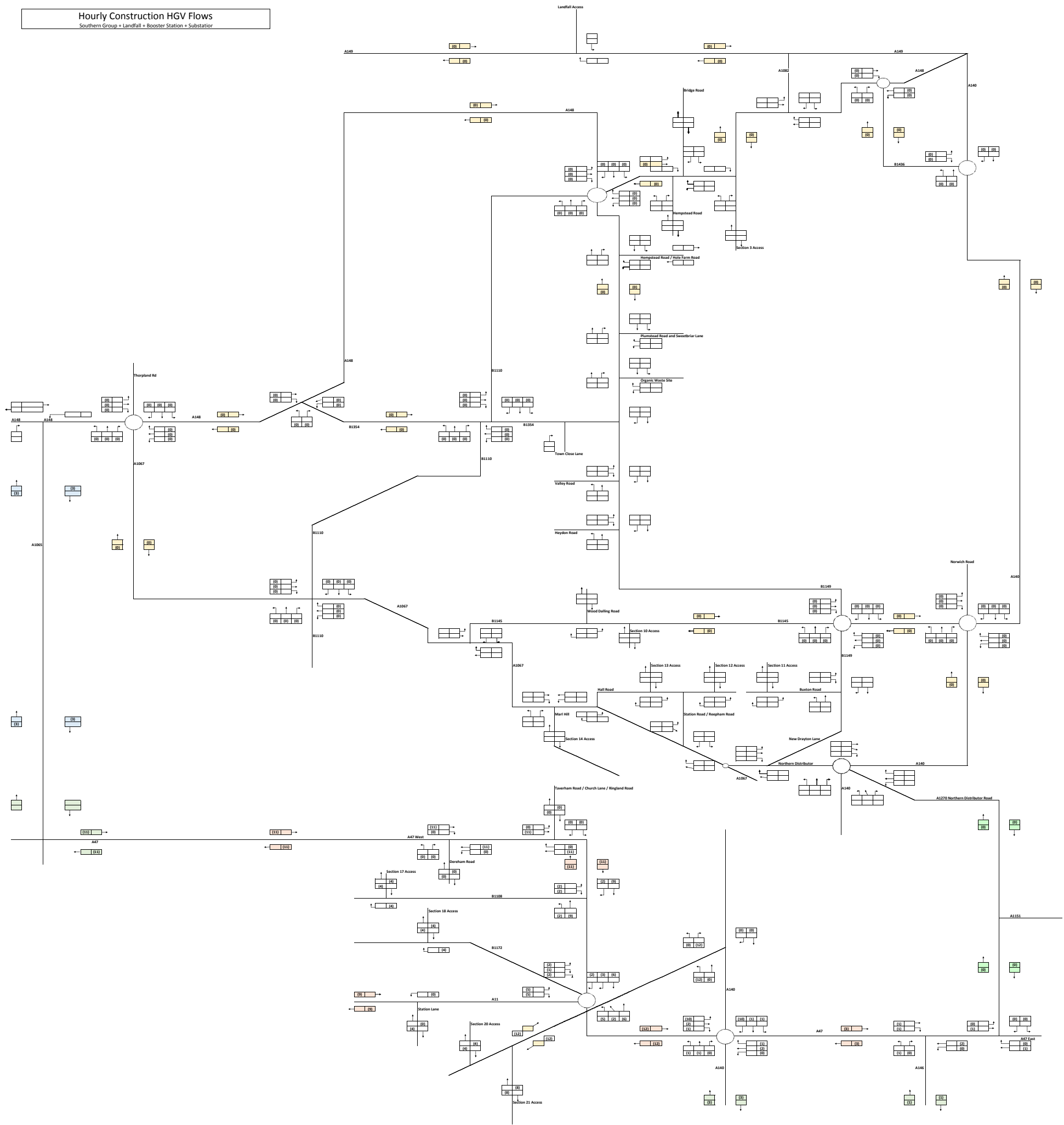

Appendix B

Traffic Flow Diagrams

Hourly Construction HGV Flows

Sensitivity Scenario

Assumptions for HGVS

Assessment year of **2022** as this is the first full year of construction of the cable route

Assume that the majority of HGVs will route from Lings Kynn, Great Yarmouth and Lowestoft

Assume	25%	from Kings Lynn
	25%	from Great Yarmouth
	25%	from Lowestoft
	50%	from A47
	0%	from A1065
	50%	from A11
	25%	from A140 south
	0%	from A140 north
	200%	

Assume **4** groups of **5** workfronts
5 adjacent workfronts to assume worst case scenario

Assume **50%** of total staff movements occur between 07:00 and 08:00
50% of total staff movements occur between 18:00 and 19:00

In reality, staff will **arrive 06:00-07:00**
depart 18:00-19:00

The local road network, for assessment purposes only, assumes staff will **arrive 07:00-08:00**
depart 18:00-19:00

The trunk road network staff assignment has staff, as predicted, **arriving 06:00 - 07:00**
departing 18:00-19:00

Assumptions for Staff

Assessment year of **2022** as this is the first full year of construction of the cable route

Assume that all staff will route via the wider highway network (A and Trunk Roads)

Assume	8%	via A148
	28%	via A47 east
	11%	from A146
	7%	from A47 west
	6%	from A1065
	16%	from A11
	13%	from A140 south
	12%	from A140 north
	100%	

Assume **4** groups of **5** workfronts
5 adjacent workfronts to assume worst case scenario

Assume **50%** of total staff movements occur between 07:00 and 08:00
50% of total staff movements occur between 18:00 and 19:00

Tables Linked to Construction Vehicle Movements 2 x 7m Spreadsheet

Route Section	Description	Hourly Vehicle Flows			
		Total	HGV	Lights	Group
1	Landfall to Holgate Hill		9		Northern
2	Holgate Hill to woodland north east of High Kelling		9		Northern
3	Woodland northeast of High Kelling to woodland south of Church Road		9		Northern
4	Woodland south of Church Road to woodland south and east of School Lane		9		Northern
5	Woodland east of School Lane to Plumstead Road		9		Northern
6	Plumstead Road to the B1149		10		Middle (northern)
7	B1149 to land South of Town Close Lane		9		-
8	Land south of Town Close Lane to woodland north of Reepham Road		9		Middle (northern)
9	Land north of Reepham Road to woodland north of Reepham		9		Middle (northern)
10	Woodland north of Reepham to woodland at Booton Common		9		Middle (northern)
11	Woodland east of Reepham to The Grove		9		Middle (northern)
12	The Grove to woodland south of Church Farm Lane		9		Middle (southern)
13	Woodland south of Church Farm Lane to River Wensum		9		Middle (southern)
14	River Wensum to woodland south west of Ringland		9		Middle (southern)
15	Woodland south west of Ringland to A47		9		Middle (southern)
16	A47 to Bawburgh Road		9		Middle (southern)
17	Bawburgh Road to woodland west of Little Melton		9		Southern
18	Woodland west of Little Melton to A11		9		Southern
19	A11 to woodland north west of Swardeston		9		Southern
20	Woodland north west of Swardeston to B1113		9		Southern
21	B1113 to end of cable route		13		Southern
Landfall	Landfall		0		
Booster Station	Booster Station		1		
Converter / Sub Station	Converter / Sub Station		3		
Total:		0	192	0	192

HGVs Assume		Staff Vehicle Movements Assume	
25%	from Kings Lynn via A148	8%	via A148
25%	from Great Yarmouth	28%	via A47 east
25%	from Lowestoft	13%	from A146
50%	from A47	7%	from A47 west
0%	from A1065	6%	from A1065
50%	from A11	16%	from A11
25%	from A140 south	13%	from A140 south
25%	from A140 north	12%	from A140 north
25%		20%	

- 0 Light Vehicles
- 5 One-Way HGVs
- 9 Two-Way HGVs

Route Section 1

Key	
10	Light Vehicles
10	Heavy Goods Vehicles (HGVs)

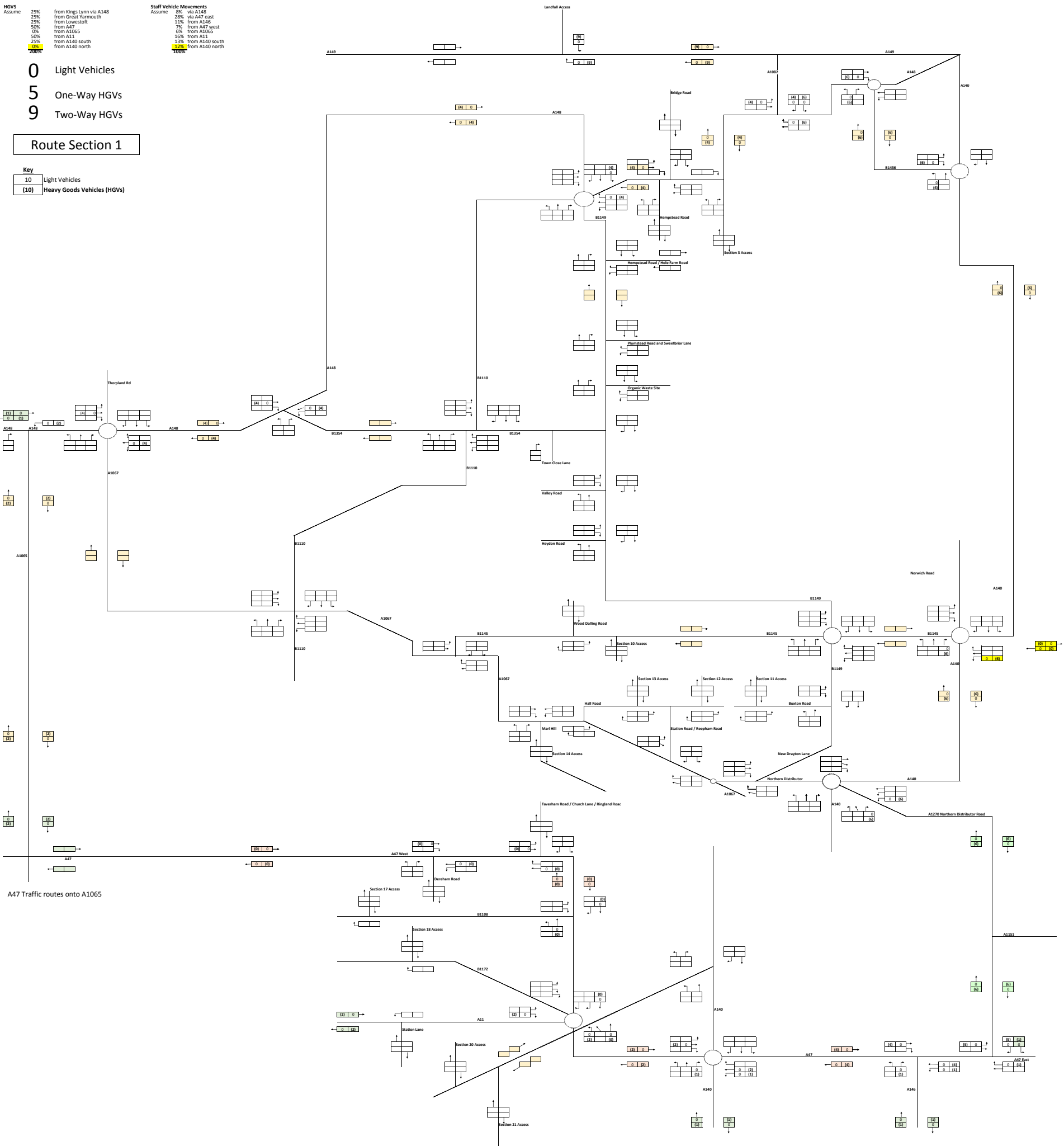

HGVs Assume	25%	from Kings Lynn via A148	Staff Vehicle Movements Assume	8%	via A148
	25%	from Great Yarmouth		28%	via A47 east
	25%	from Lowestoft		11%	from A146
	50%	from A47		7%	from A47 west
	0%	from A1065		6%	from A1065
	50%	from A11		16%	from A11
25%	from A140 south	13%	from A140 south		
25%	from A140 north	12%	from A140 north		
25%		10%			

- 0 Light Vehicles
- 4 One-Way HGVs
- 9 Two-Way HGVs

Route Section 2

10	Light Vehicles
10	Heavy Goods Vehicles (HGVs)

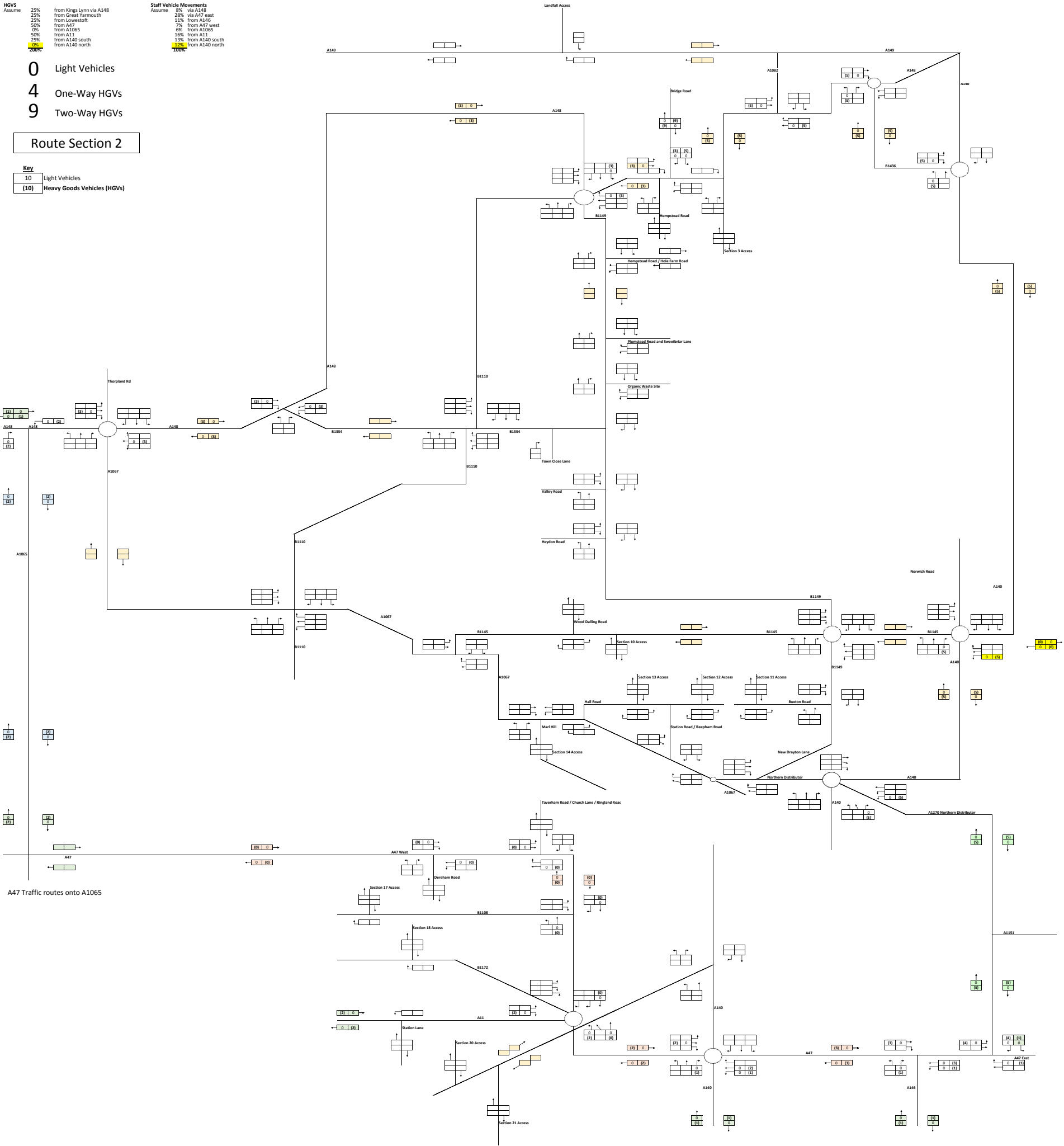

HGVs Assume		Staff Vehicle Movements Assume	
25%	from Kings Lynn via A148	8%	via A148
25%	from Great Yarmouth	28%	via A47 east
25%	from Lowestoft	11%	from A146
50%	from A47	7%	from A47 west
0%	from A1065	6%	from A1065
50%	from A11	16%	from A11
25%	from A140 south	13%	from A140 south
25%	from A140 north	12%	from A140 north
25%		10%	

- 0 Light Vehicles
- 4 Total HGVs
- 9 Two-Way HGVs

Route Section 3

Key	
10	Light Vehicles
10	Heavy Goods Vehicles (HGVs)

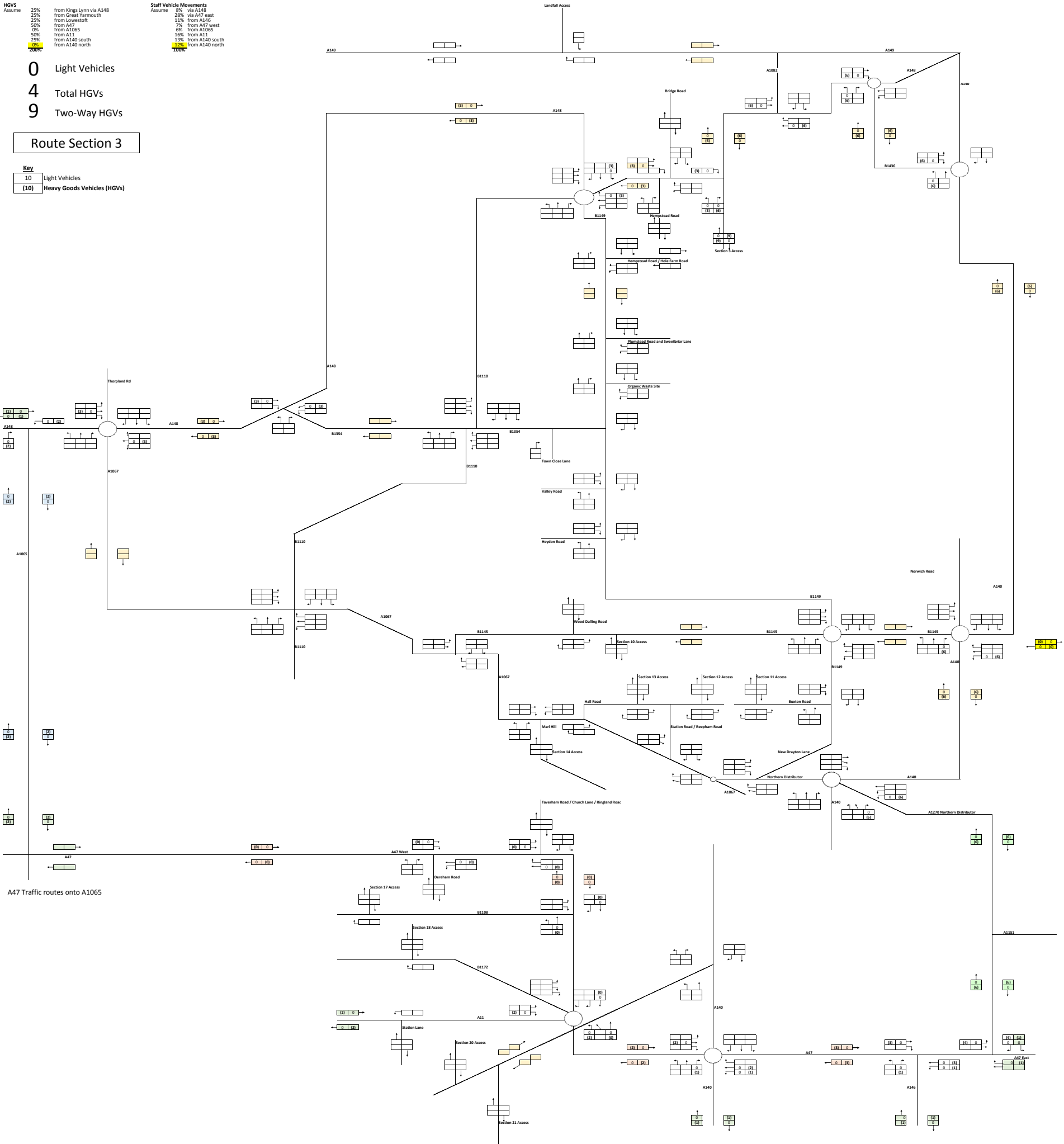

HGVs Assume	25%	from Kings Lynn via A148
	25%	from Great Yarmouth
	25%	from Lowestoft
	50%	from A47
	0%	from A1065
	50%	from A11
	25%	from A140 south
	25%	from A140 north
	25%	from A140 north
	25%	from A140 north

Staff Vehicle Movements Assume	8%	via A148
	28%	via A47 east
	11%	from A146
	7%	from A47 west
	6%	from A1065
	16%	from A11
	13%	from A140 south
	12%	from A140 north
	10%	from A140 north

- 0** Light Vehicles
- 4** Total HGVs
- 9** Two-Way HGVs

Route Section 4

10	Light Vehicles
10	Heavy Goods Vehicles (HGVs)

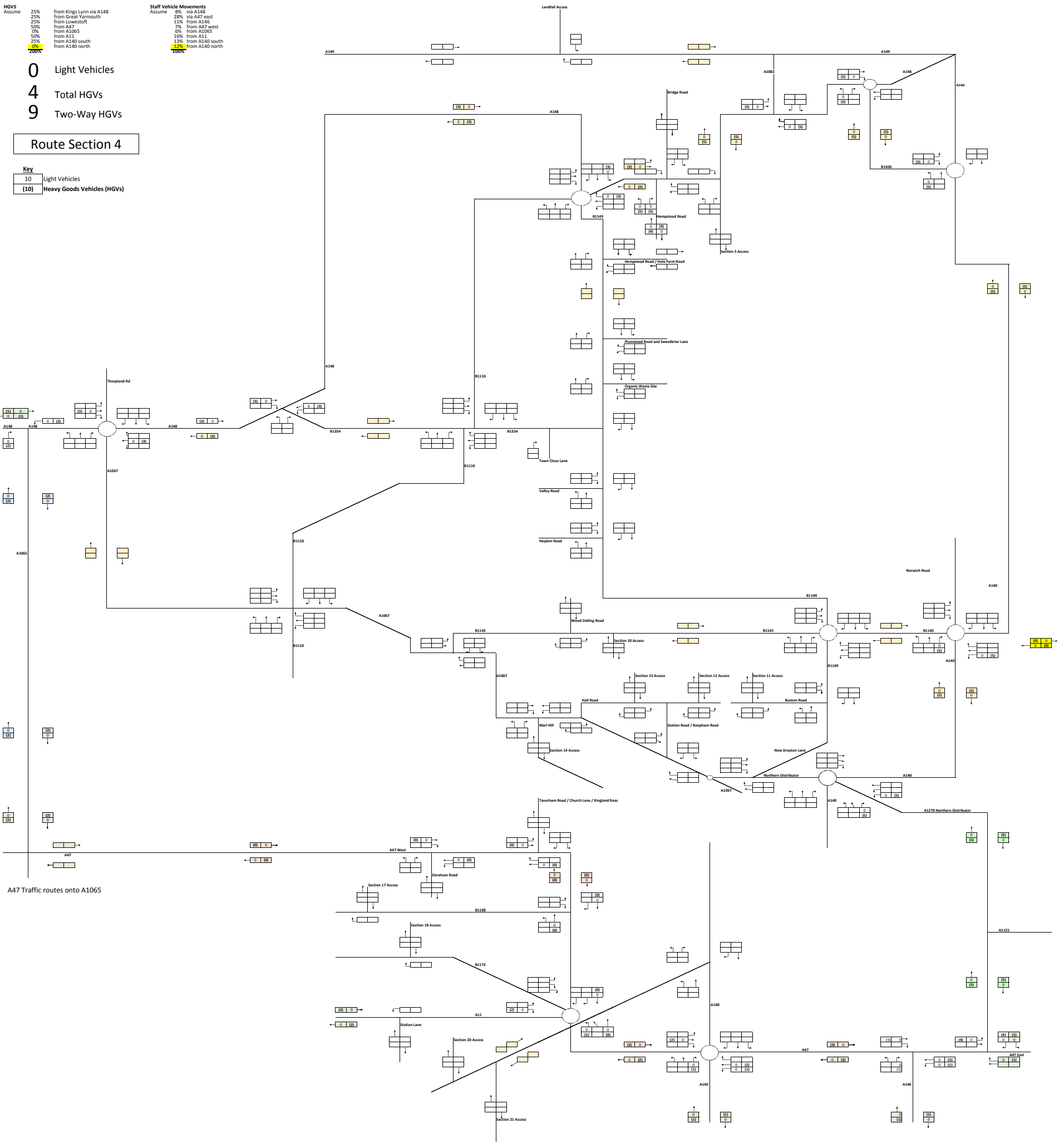

A47 Traffic routes onto A1065

HGVs Assume	25%	from Kings Lynn via A148	Staff Vehicle Movements Assume	8%	via A148
	25%	from Great Yarmouth		28%	via A27 east
	25%	from Lowestoft		11%	from A146
	50%	from A27		7%	from A27 west
	0%	from A1065		6%	from A1065
	50%	from A11		16%	from A11
	25%	from A140 south		13%	from A140 south
	25%	from A140 north		12%	from A140 north
	25%			10%	

- 0** Light Vehicles
- 4** Total HGVs
- 9** Two-Way HGVs

Route Section 5

Key	
10	Light Vehicles
10	Heavy Goods Vehicles (HGVs)

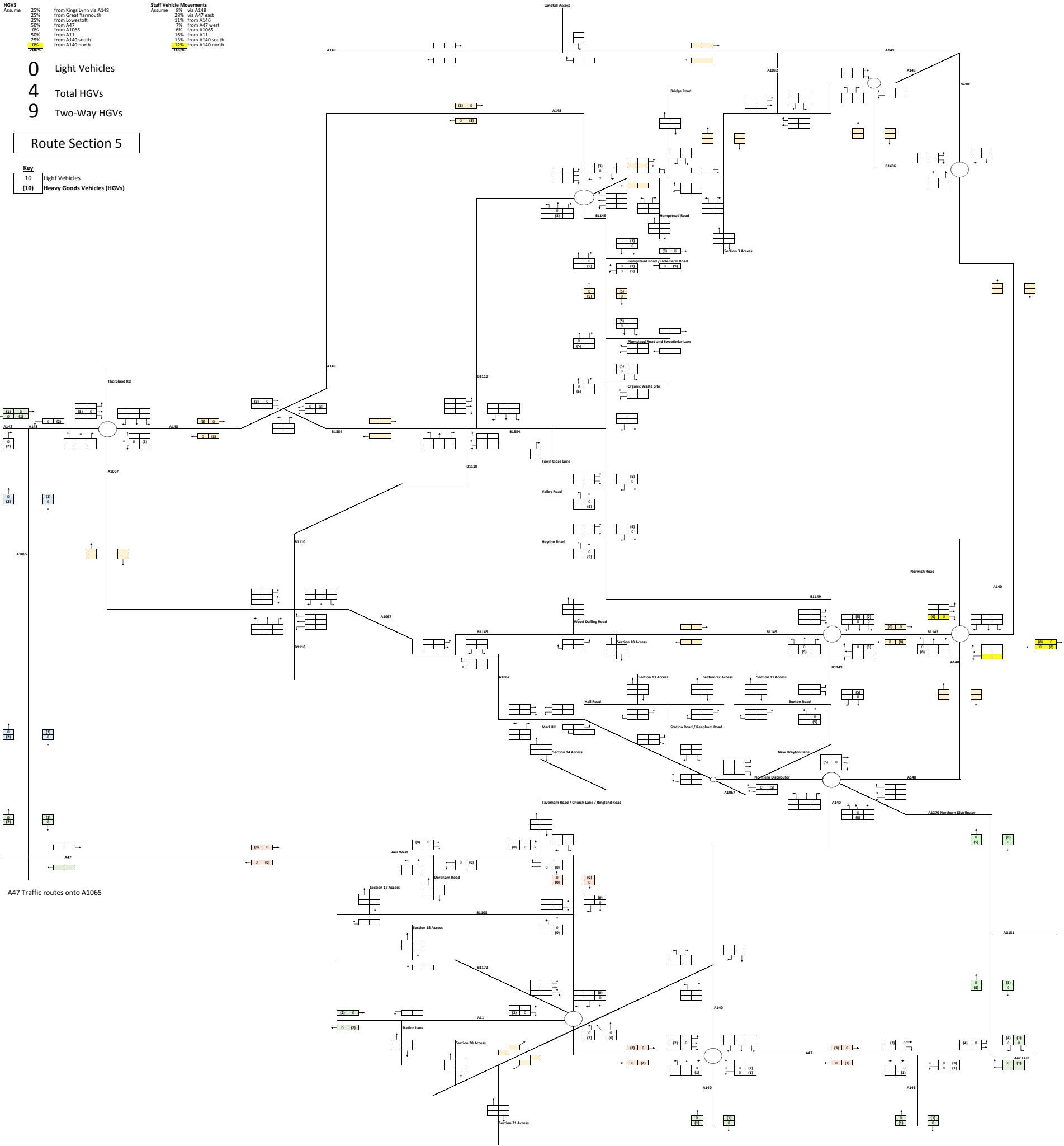

A47 Traffic routes onto A1065

Northern Group Total

0 Light Vehicles
 22 Total HGVs
 44 Two-way HGVs

10	Total Vehicles
(10)	Heavy Goods Vehicles (HGVs)

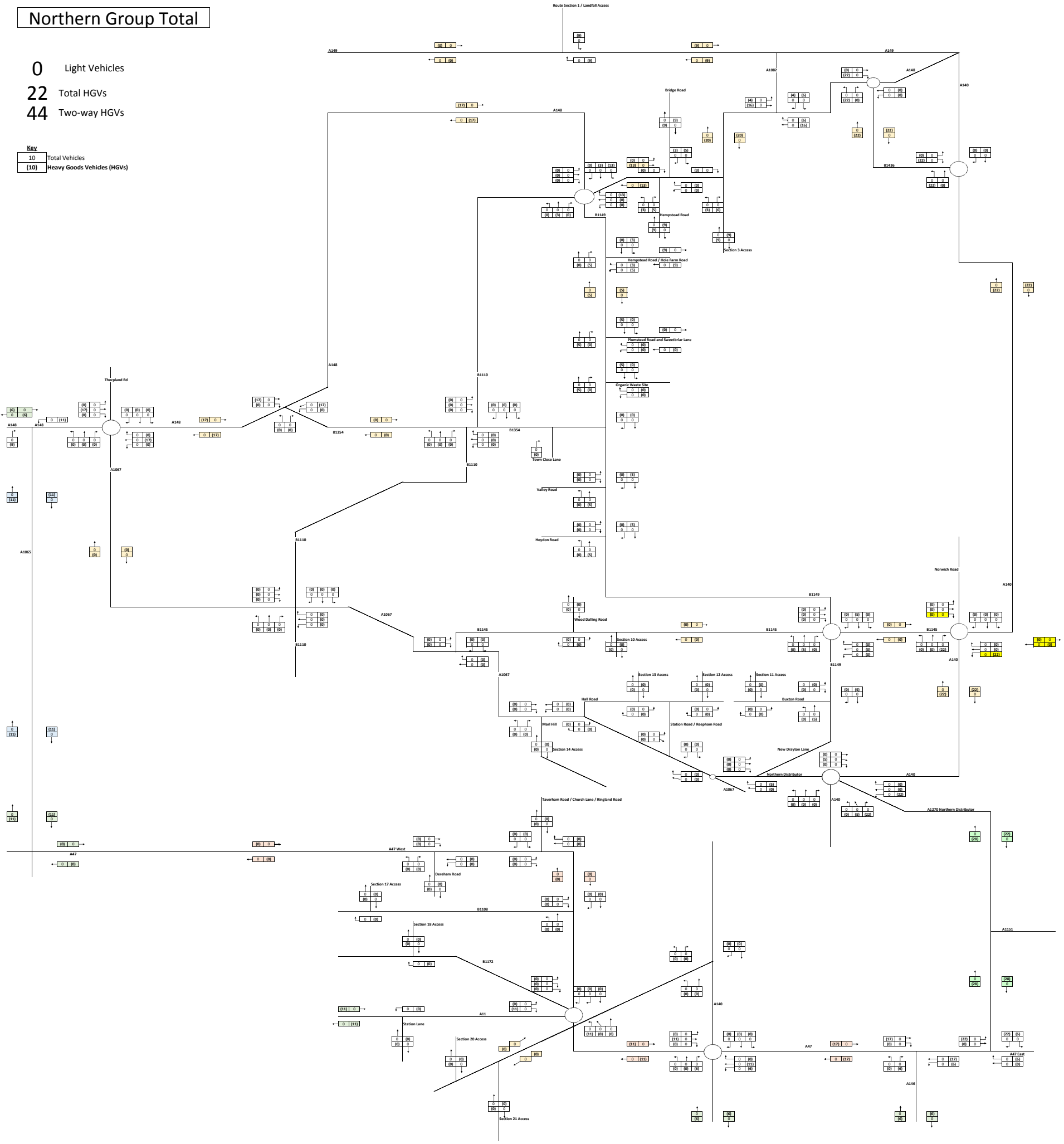

HGVs Assume		Staff Vehicle Movements Assume	
25%	from Kings Lynn via A148	8%	via A148
25%	from Great Yarmouth	28%	via A47 east
25%	from Lowestoft	11%	from A146
50%	from A47	7%	from A47 west
0%	from A1065	0%	from A1065
50%	from A11	10%	from A11
25%	from A140 south	13%	from A140 south
25%	from A140 north	12%	from A140 north
25%		10%	

- 0 Light Vehicles
- 5 Total HGVs
- 10 Two-Way HGVs

Route Section 6

Key	
10	Light Vehicles
10	Heavy Goods Vehicles (HGVs)

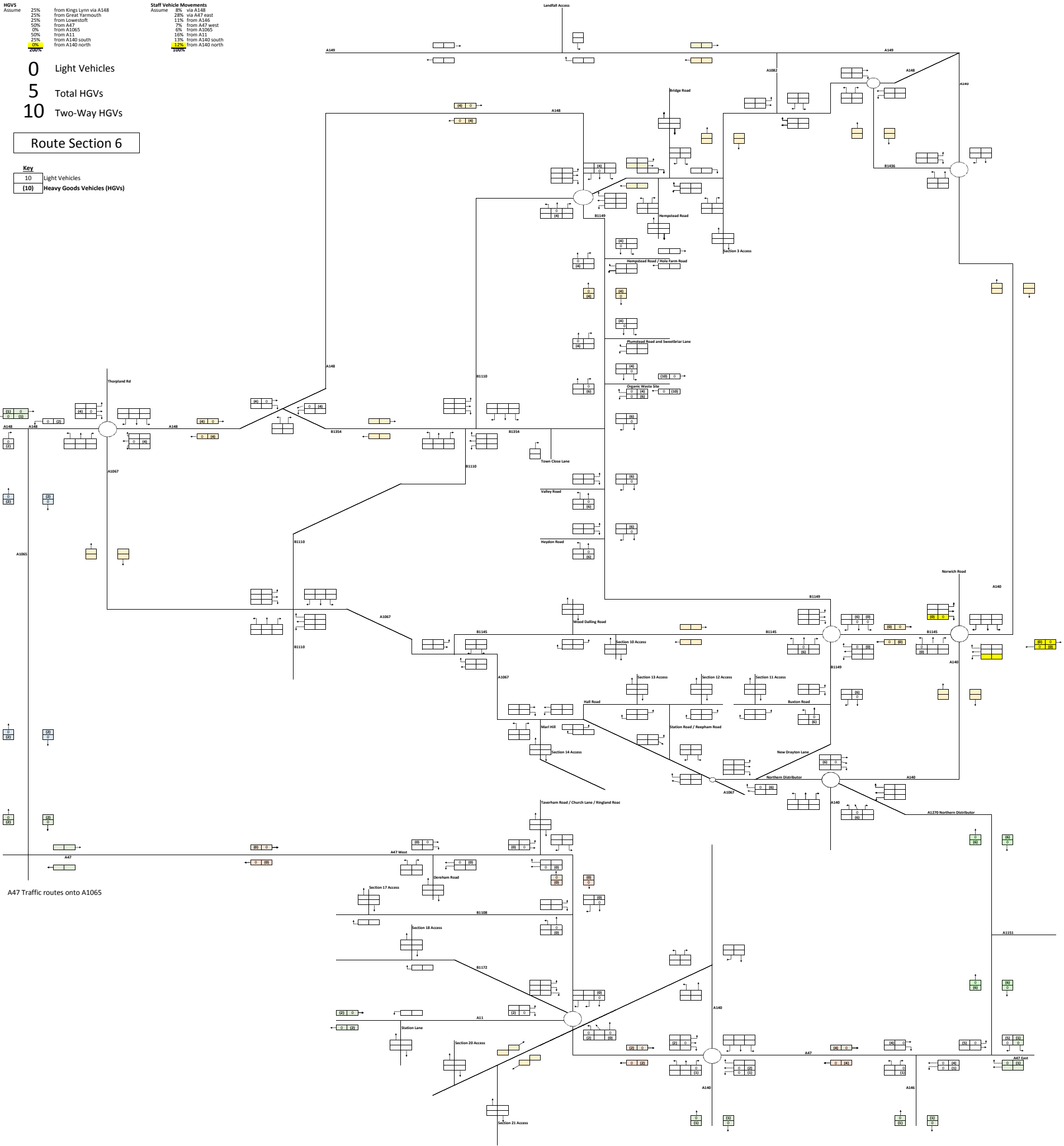

A47 Traffic routes onto A1065

HGVs Assume	25%	from Kings Lynn via A148	Staff Vehicle Movements Assume	8%	via A148
	25%	from Great Yarmouth		28%	via A47 east
	25%	from Lowestoft		11%	from A146
	50%	from A47		7%	from A47 west
	0%	from A1065		6%	from A1065
	50%	from A11		16%	from A11
	25%	from A140 south		13%	from A140 south
	25%	from A140 north		12%	from A140 north
	25%			12%	

- 0 Light Vehicles
- 4 Total HGVs
- 9 Two-Way HGVs

Route Section 8

10	Light Vehicles
10	Heavy Goods Vehicles (HGVs)

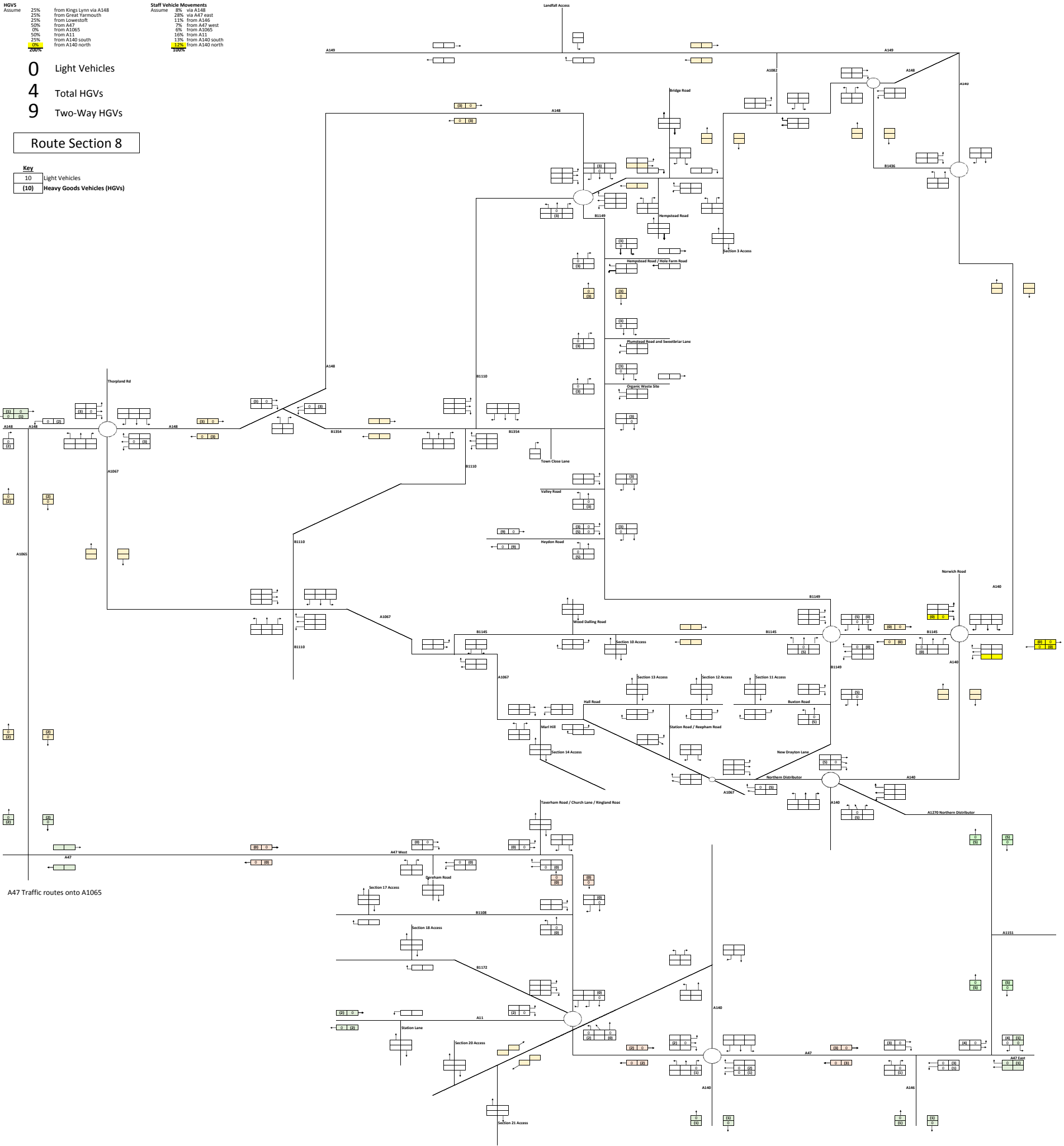

HGVs		Staff Vehicle Movements	
Assume	25%	Assume	8%
	25%		28%
	25%		11%
	50%		7%
	0%		6%
	50%		16%
	25%		13%
	25%		12%
	25%		12%

- 0 Light Vehicles
- 4 Total HGVs
- 9 Two-Way HGVs

Route Section 9

Key	
10	Light Vehicles
10	Heavy Goods Vehicles (HGVs)

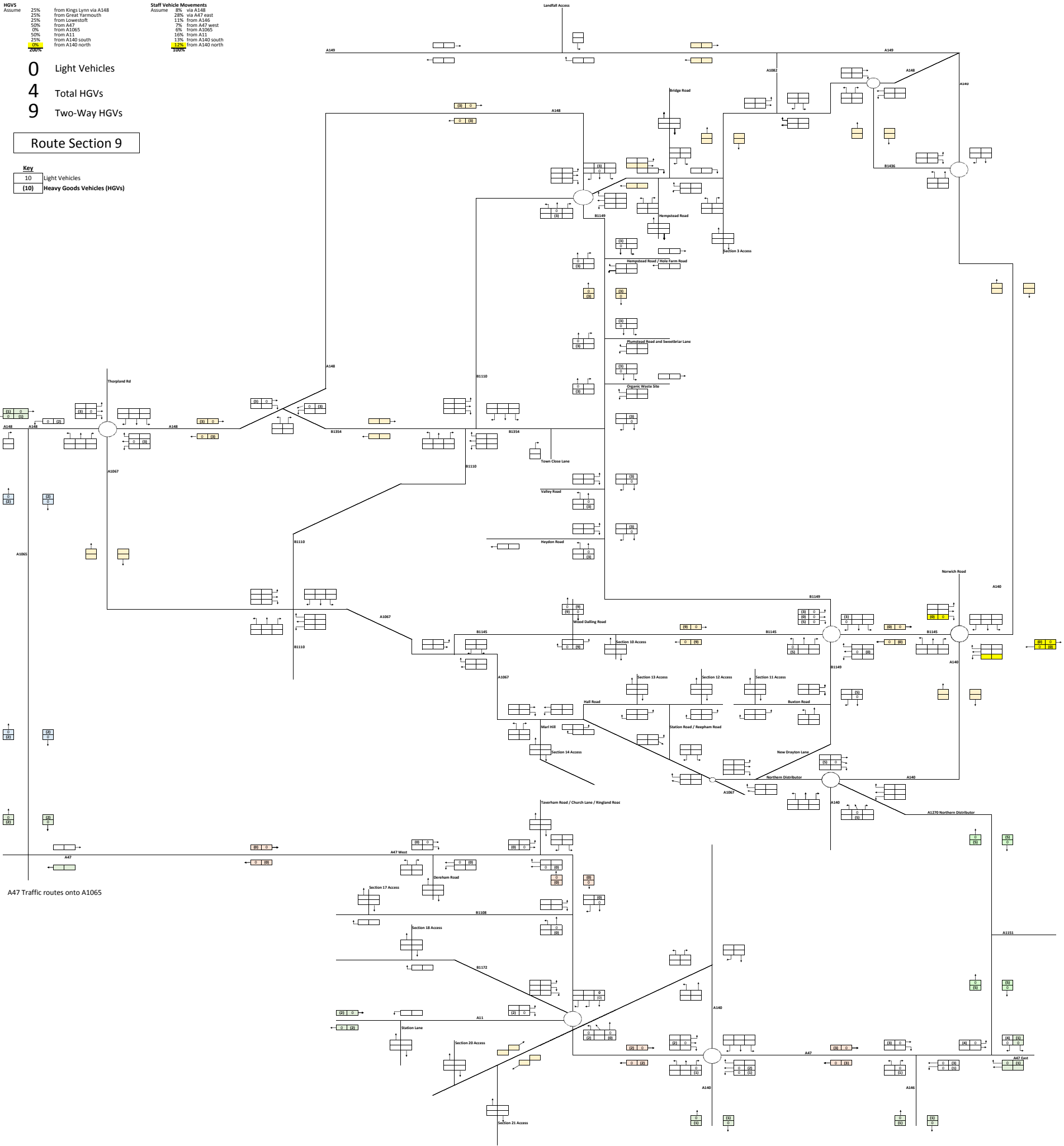

A47 Traffic routes onto A1065

HGVs	25%	from Kings Lynn via A148	Staff Vehicle Movements	28%	via A148
Assume	25%	from Great Yarmouth	Assume	11%	from A146
	25%	from Lowestoft		7%	from A47 west
	50%	from A47		6%	from A1065
	0%	from A1065		16%	from A11
	50%	from A11		13%	from A140 south
	25%	from A140 south		12%	from A140 north
	25%	from A140 north		12%	from A140 north
	25%			12%	

- 0 Light Vehicles
- 4 Total HGVs
- 9 Two-Way HGVs

Route Section 10

10	Light Vehicles
10	Heavy Goods Vehicles (HGVs)

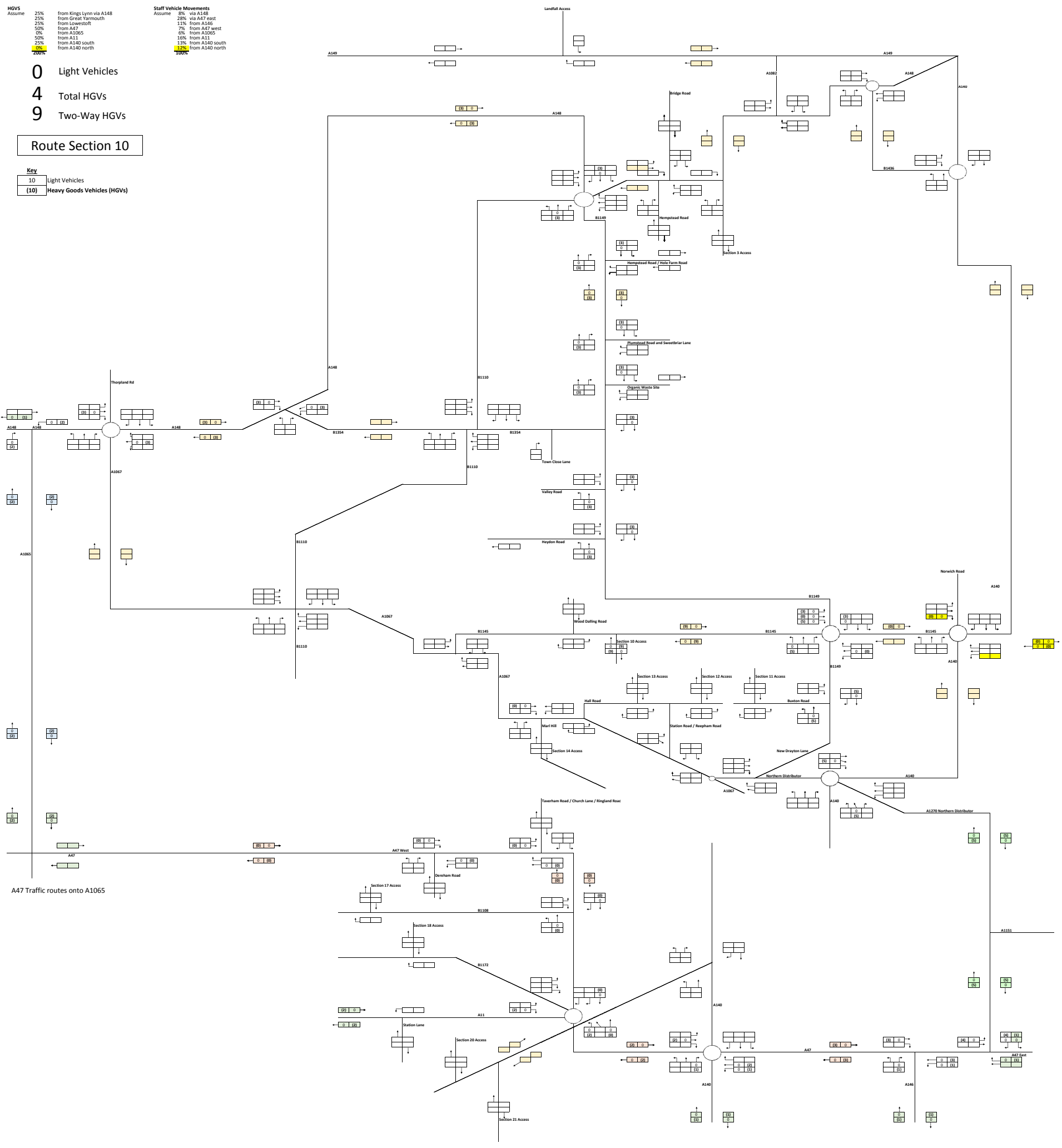

A47 Traffic routes onto A1065

HGVs	25%	from Kings Lynn via A148	Staff Vehicle Movements	28%	via A148
Assume	25%	from Great Yarmouth	Assume	11%	from A146
	25%	from Lowestoft		7%	from A47 west
	50%	from A47		6%	from A1065
	0%	from A1065		16%	from A11
	25%	from A140 south		13%	from A140 south
	25%	from A140 north		12%	from A140 north
	25%	from A140 north		12%	from A140 north

- 0 Light Vehicles
- 4 Total HGVs
- 9 Two-Way HGVs

Route Section 11

10	Light Vehicles
10	Heavy Goods Vehicles (HGVs)

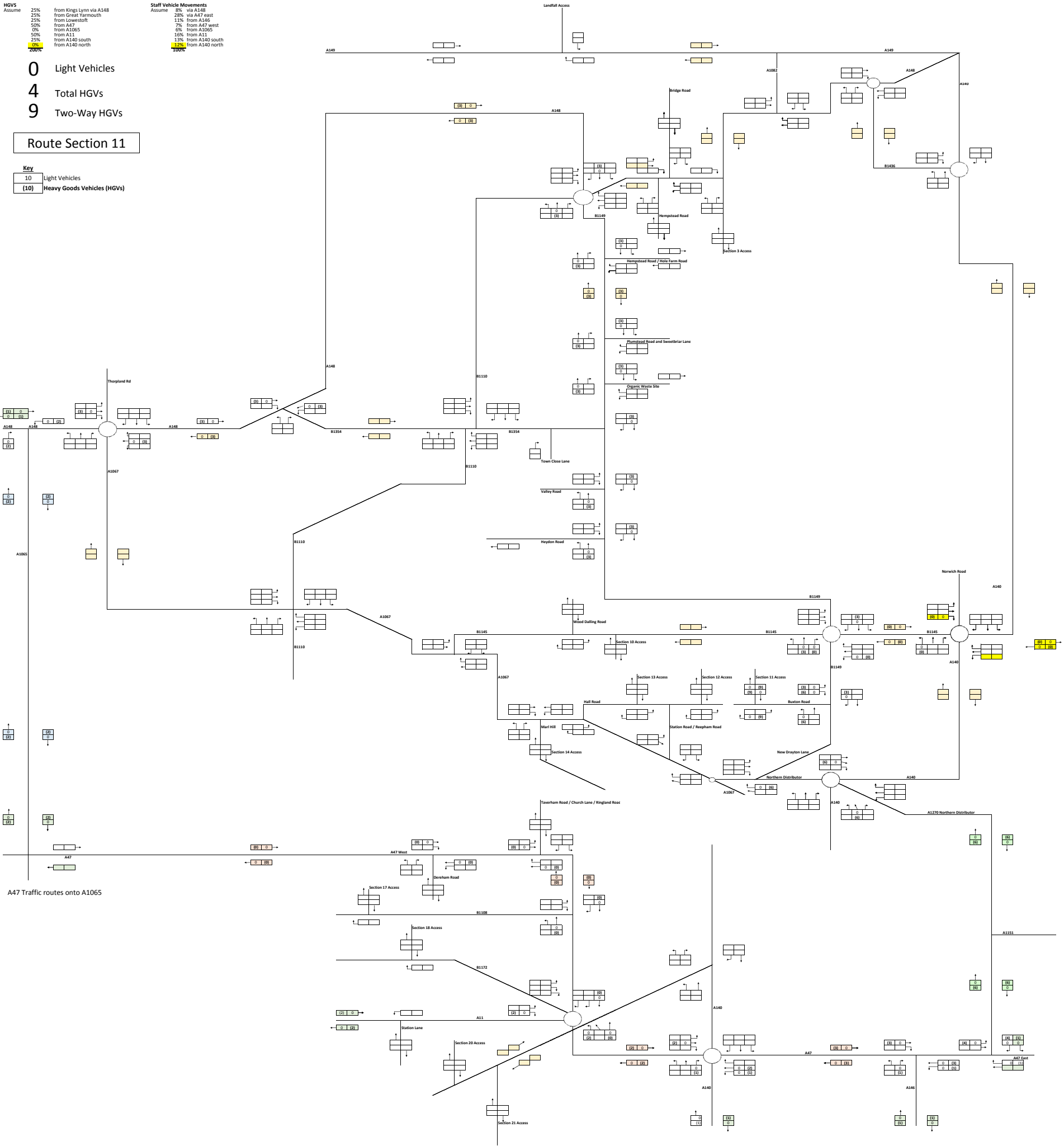

Middle (northern) Group Total

- 0 Light Vehicles
- 22 Total HGVs
- 44 Two-way HGVs

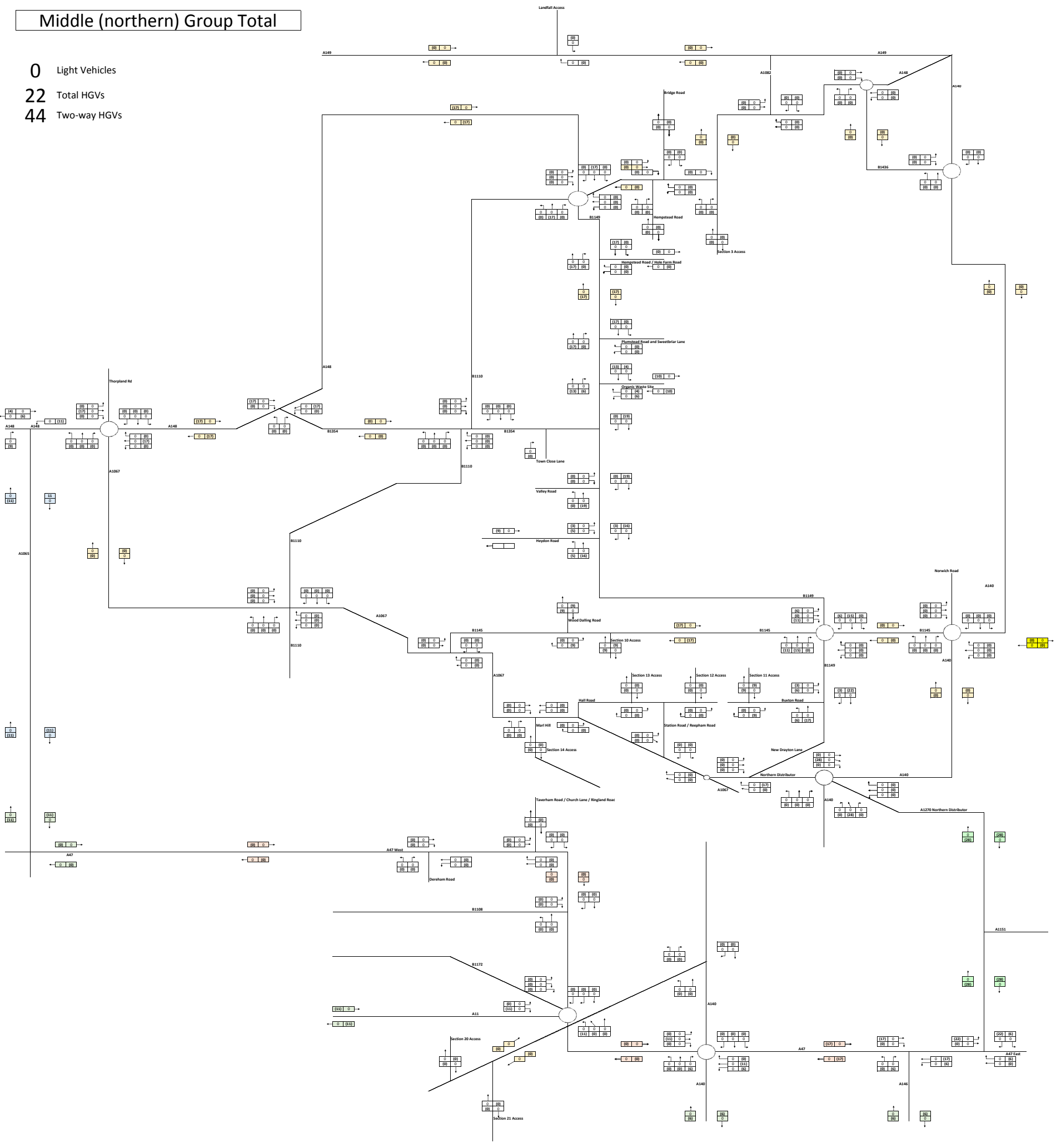

HGVs Assume	25%	from Kings Lynn via A148	Staff Vehicle Movements Assume	8%	via A148
	25%	from Great Yarmouth		28%	via A47 east
	25%	from Lowestoft		11%	from A146
	50%	from A47		7%	from A47 west
	0%	from A1065		6%	from A1065
	50%	from A11		16%	from A11
	25%	from A140 south		13%	from A140 south
	25%	from A140 north		12%	from A140 north
	25%			12%	

- 0 Light Vehicles
- 4 Total HGVs
- 9 Two-Way HGVs

Route Section 12

10	Light Vehicles
10	Heavy Goods Vehicles (HGVs)

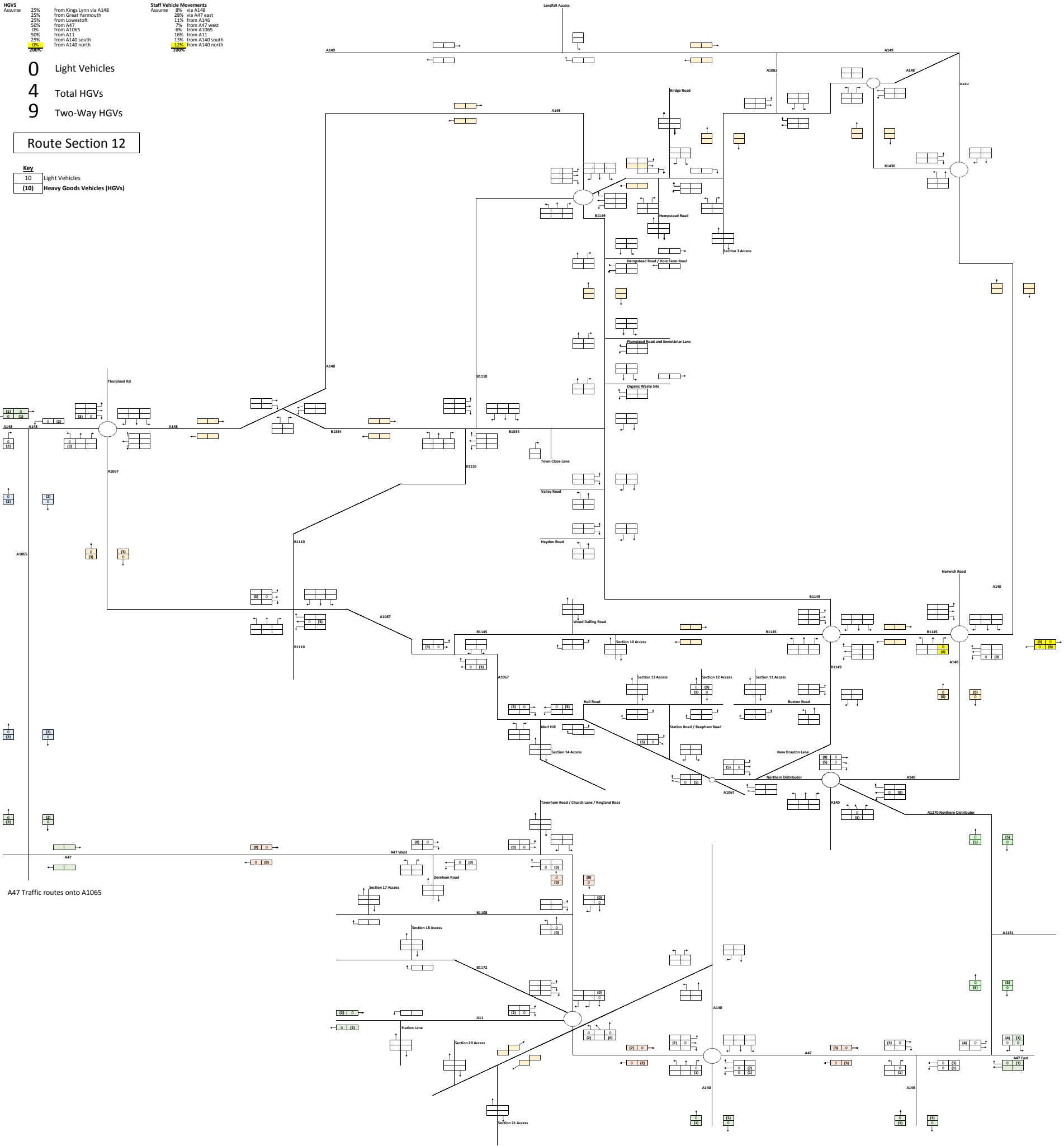

HGVs Assume	25%	from Kings Lynn via A148	Staff Vehicle Movements Assume	8%	via A148
	25%	from Great Yarmouth		28%	via A47 east
	25%	from Lowestoft		11%	from A146
	50%	from A47		7%	from A47 west
	0%	from A1065		6%	from A1065
	50%	from A11		16%	from A11
	25%	from A140 south		13%	from A140 south
	25%	from A140 north		12%	from A140 north
	25%			12%	

- 0 Light Vehicles
- 4 Total HGVs
- 9 Two-Way HGVs

Route Section 13

10	Light Vehicles
10	Heavy Goods Vehicles (HGVs)

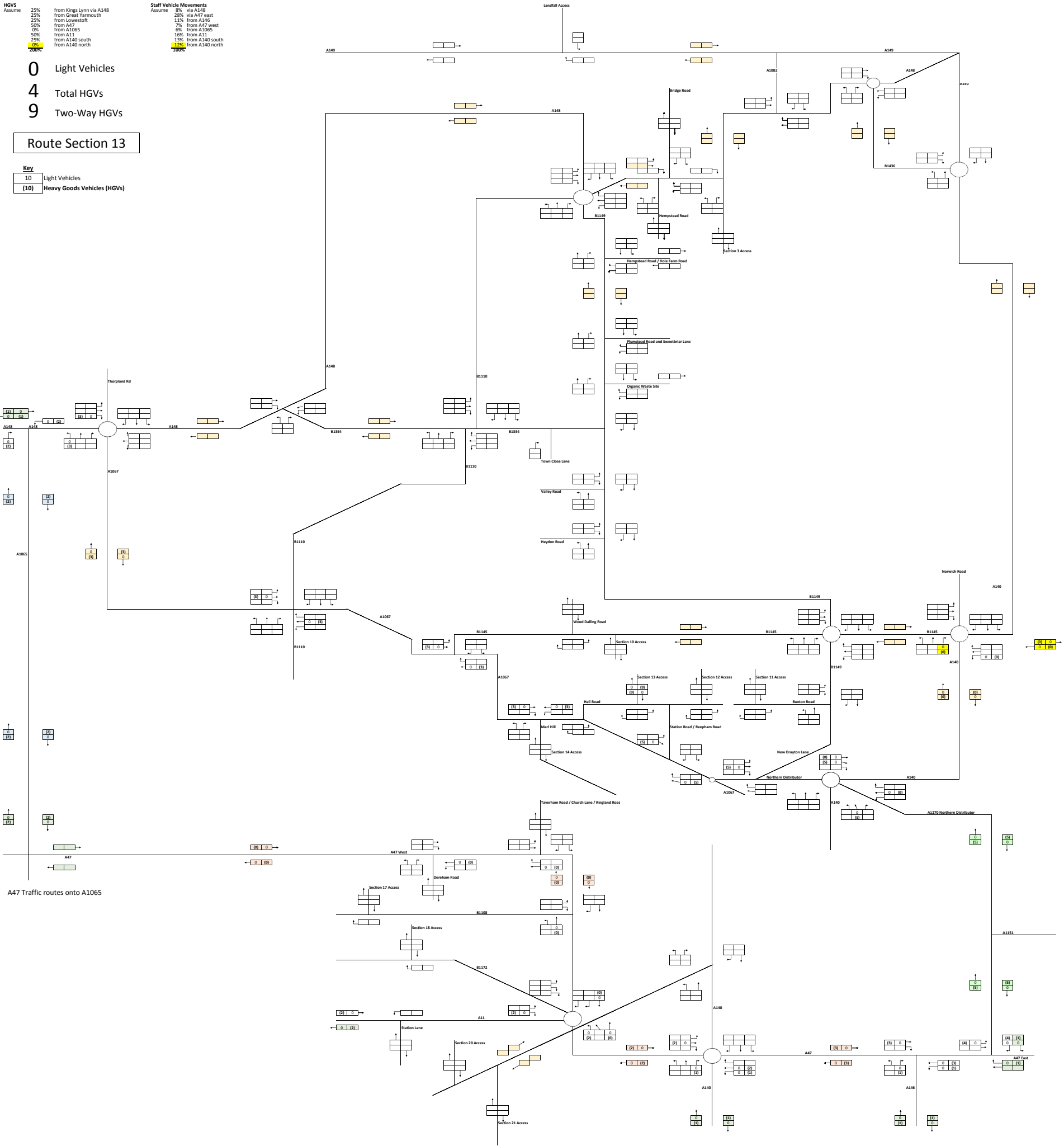

HGVs	25%	from Kings Lynn via A148	Staff Vehicle Movements	28%	via A148
Assume	25%	from Great Yarmouth	Assume	11%	from A146
	25%	from Lowestoft		7%	from A147 west
	50%	from A47		6%	from A1065
	0%	from A1065		10%	from A11
	25%	from A140 south		13%	from A140 south
	25%	from A140 north		12%	from A140 north
	25%	from A140 north		12%	from A140 north

- 0 Light Vehicles
- 4 Total HGVs
- 9 Two-Way HGVs

Route Section 14

10	Light Vehicles
10	Heavy Goods Vehicles (HGVs)

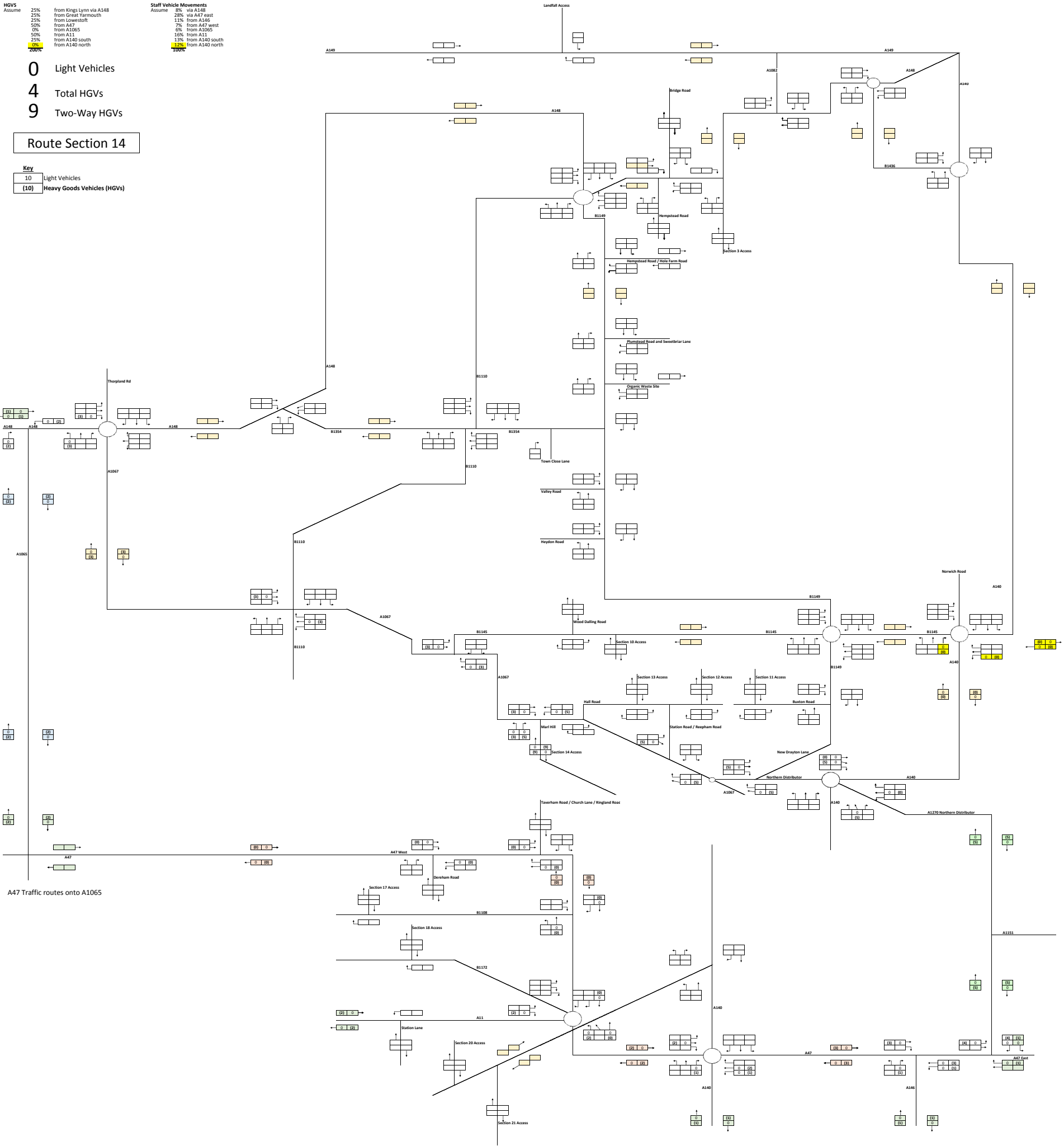

HGVs Assume		Staff Vehicle Movements Assume	
25%	from Kings Lynn via A47	8%	via A148
25%	from Great Yarmouth	28%	via A47 east
25%	from Lowestoft	11%	from A146
50%	from A47	7%	from A47 west
0%	from A1065 via A47	6%	from A1065
50%	from A11	16%	from A11
25%	from A140 south	13%	from A140 south
25%	from A140 north	12%	from A140 north
25%		20%	

- 0 Light Vehicles
- 4 Total HGVs
- 9 Two-Way HGVs

Route Section 15

Key	
10	Light Vehicles
10	Heavy Goods Vehicles (HGVs)

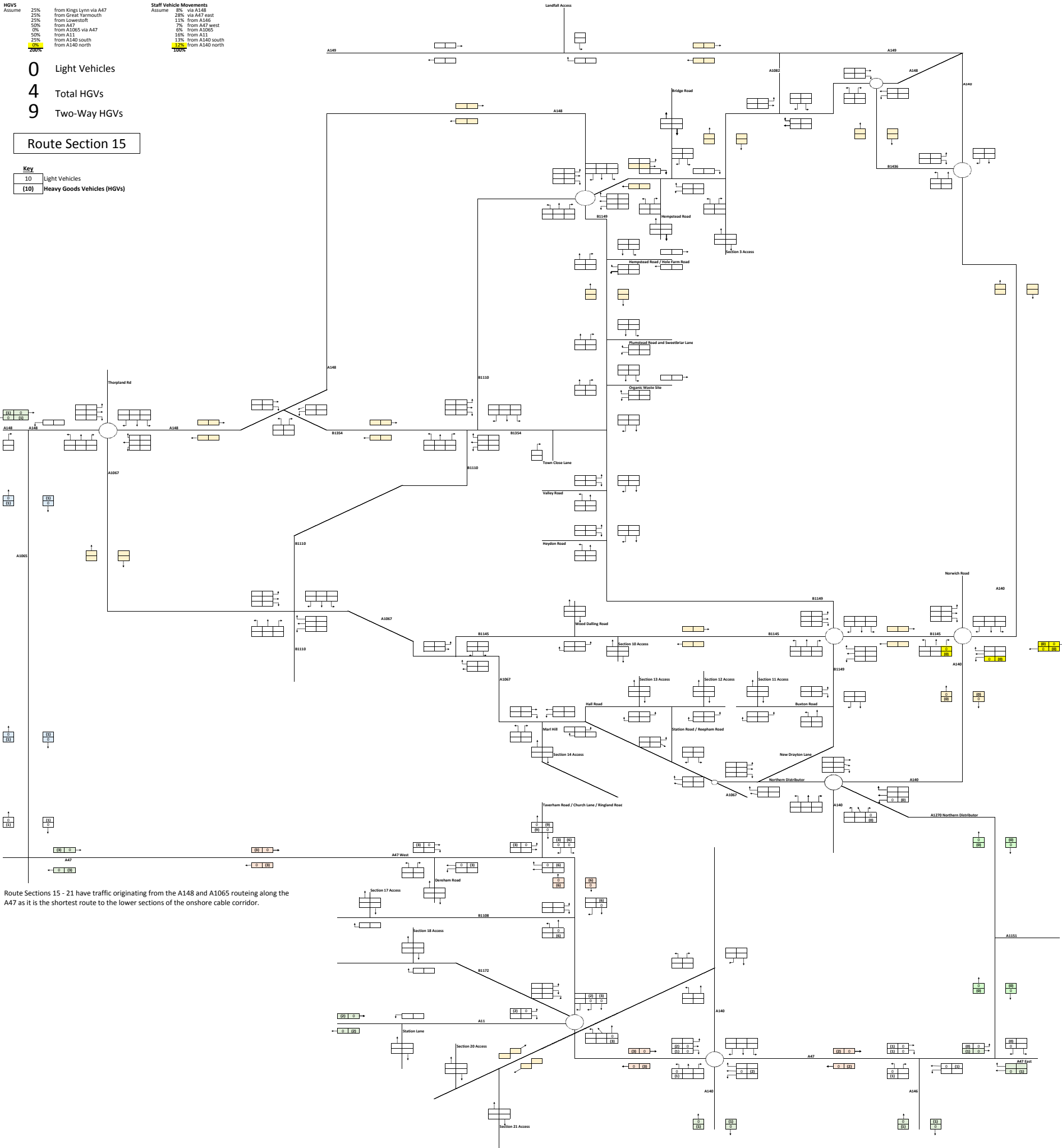

Route Sections 15 - 21 have traffic originating from the A148 and A1065 routing along the A47 as it is the shortest route to the lower sections of the onshore cable corridor.

HGVs	25%	from Kings Lynn via A47	Staff Vehicle Movements	28%	via A148
Assume	25%	from Great Yarmouth	Assume	11%	from A146
	25%	from Lowestoft		7%	from A47 west
	50%	from A47		6%	from A1065
	0%	from A1065 via A47		10%	from A11
	25%	from A148 south		13%	from A140 south
	25%	from A148 north		12%	from A140 north
	25%	from A140 north		12%	from A140 north

- 0 Light Vehicles
- 4 Total HGVs
- 9 Two-Way HGVs

Route Section 16

10	Light Vehicles
10	Heavy Goods Vehicles (HGVs)

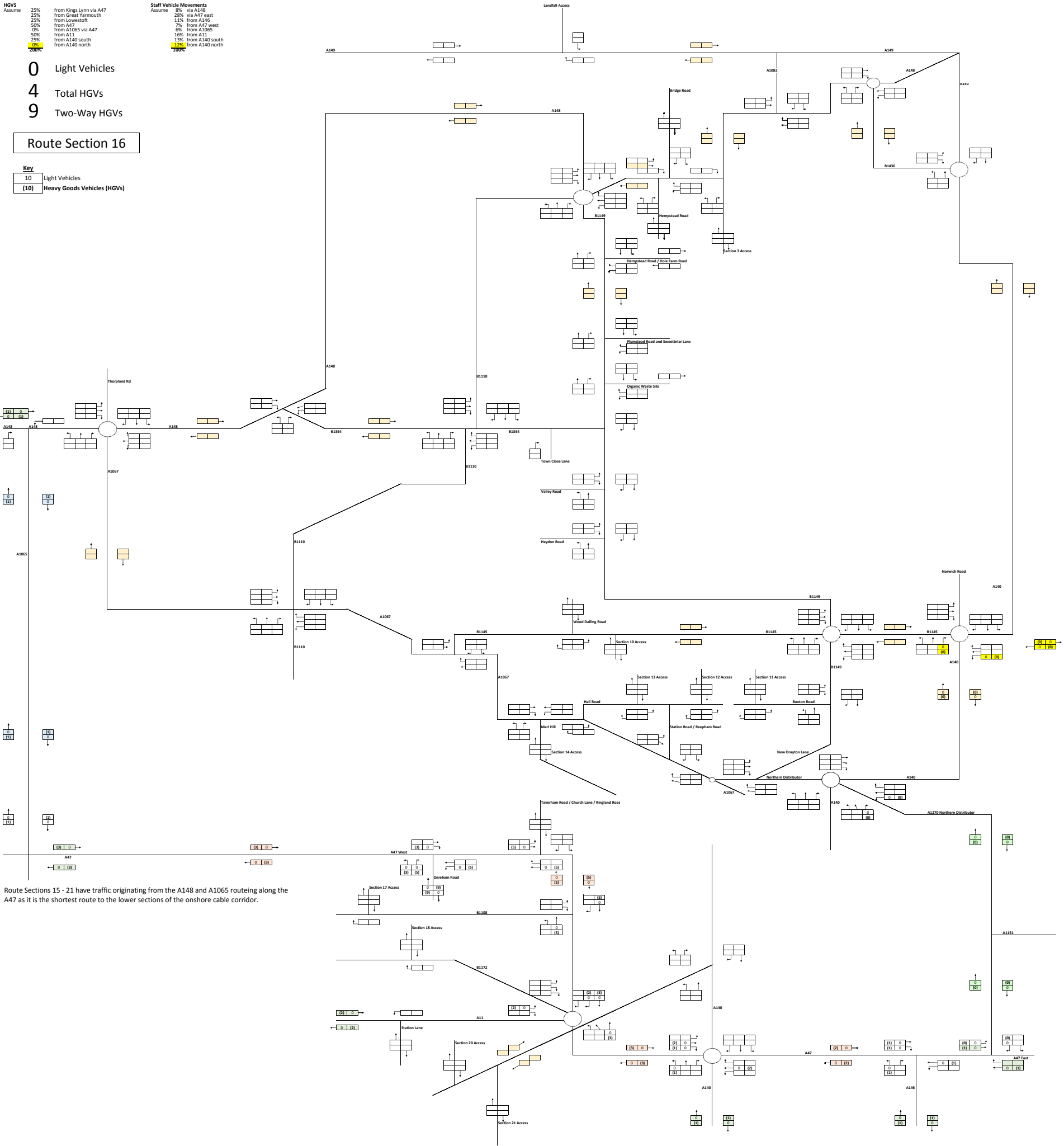

Route Sections 15 - 21 have traffic originating from the A148 and A1065 routing along the A47 as it is the shortest route to the lower sections of the onshore cable corridor.

Middle (southern) Group Total

- 0 Light Vehicles
- 22 Total HGVs
- 44 Total HGVs

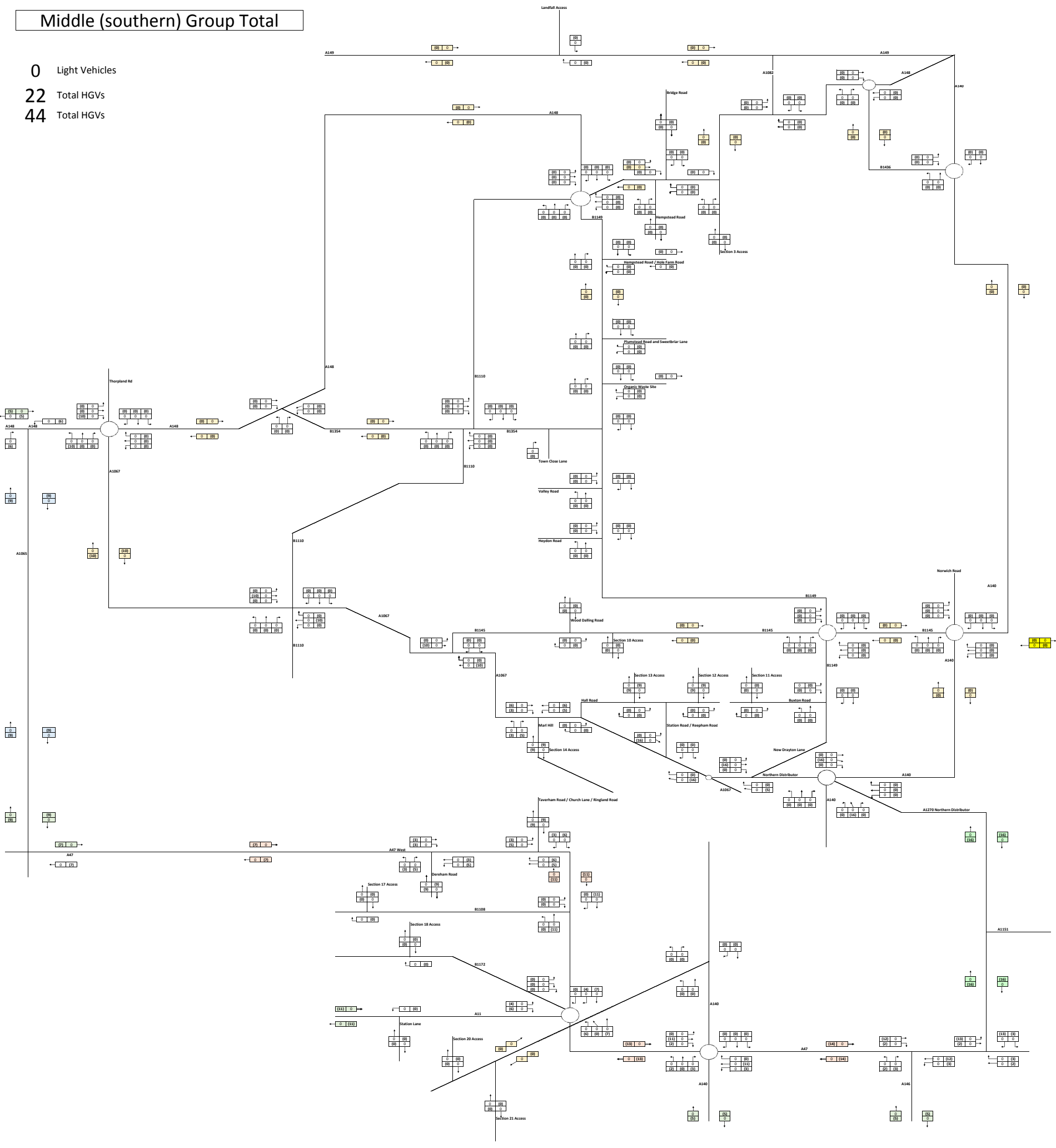

HGVs Assume	25%	from Kings Lynn via A47	Staff Vehicle Movements Assume	8%	via A148
	25%	from Great Yarmouth		28%	via A47 east
	25%	from Lowestoft		11%	from A146
	50%	from A47		7%	from A47 west
	0%	from A1065 via A47		6%	from A1065
	50%	from A11		16%	from A11
	25%	from A140 south		13%	from A140 south
	25%	from A140 north		12%	from A140 north
	25%	from A140 north		12%	from A140 north

- 0 Light Vehicles
- 4 Total HGVs
- 9 Two-Way HGVs

Route Section 17

10	Light Vehicles
10	Heavy Goods Vehicles (HGVs)

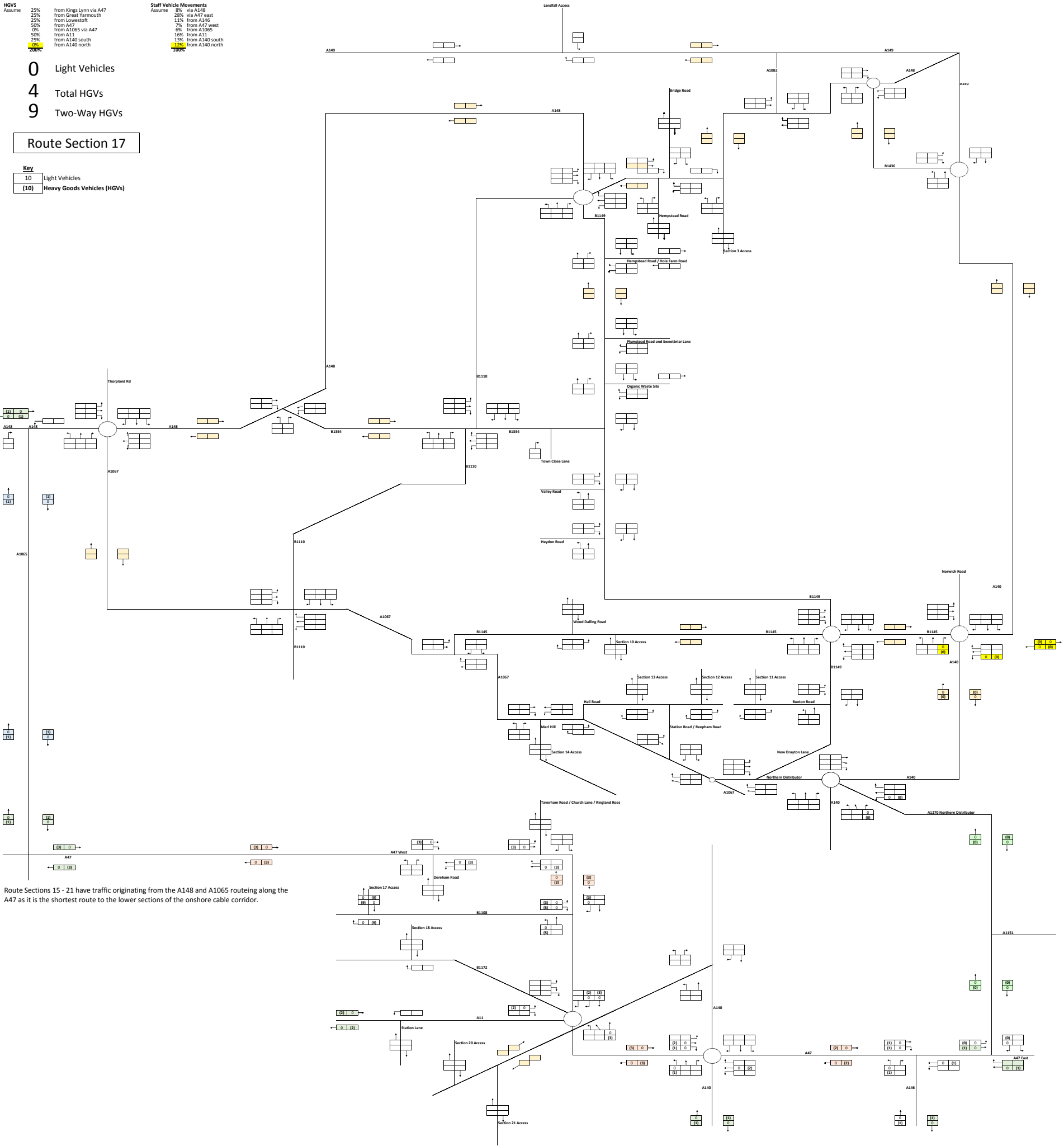

Route Sections 15 - 21 have traffic originating from the A148 and A1065 routing along the A47 as it is the shortest route to the lower sections of the onshore cable corridor.

HGVs	25%	from Kings Lynn via A47	Staff Vehicle Movements	28%	via A148
Assume	25%	from Great Yarmouth	Assume	11%	from A146
	25%	from Lowestoft		7%	from A47 west
	50%	from A47		6%	from A1065
	0%	from A1065 via A47		10%	from A11
	25%	from A148 south		13%	from A140 south
	25%	from A148 north		12%	from A140 north
	25%	from A140 north		10%	from A140 north

- 0 Light Vehicles
- 4 Total HGVs
- 9 Two-Way HGVs

Route Section 18

10	Light Vehicles
10	Heavy Goods Vehicles (HGVs)

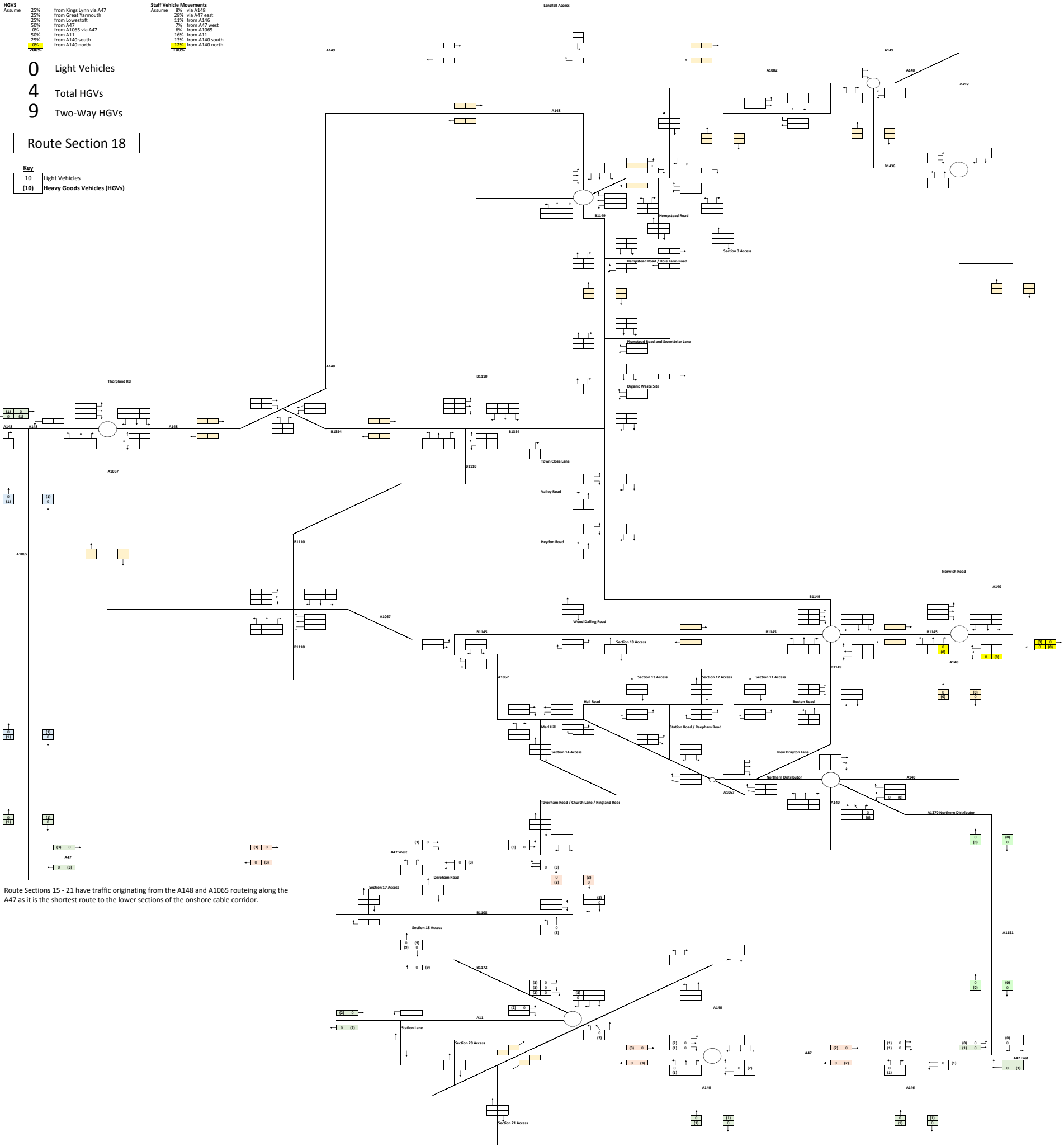

Route Sections 15 - 21 have traffic originating from the A148 and A1065 routing along the A47 as it is the shortest route to the lower sections of the onshore cable corridor.

HGVs	25%	from Kings Lynn via A47	Staff Vehicle Movements	28%	via A148
Assume	25%	from Great Yarmouth	Assume	11%	from A146
	25%	from Lowestoft		7%	from A47 west
	50%	from A47		6%	from A1065
	0%	from A1065 via A47		10%	from A11
	25%	from A148 south		13%	from A140 south
	25%	from A148 north		12%	from A140 north
	25%			12%	

- 0 Light Vehicles
- 4 Total HGVs
- 9 Two-Way HGVs

Route Section 19

10	Light Vehicles
10	Heavy Goods Vehicles (HGVs)

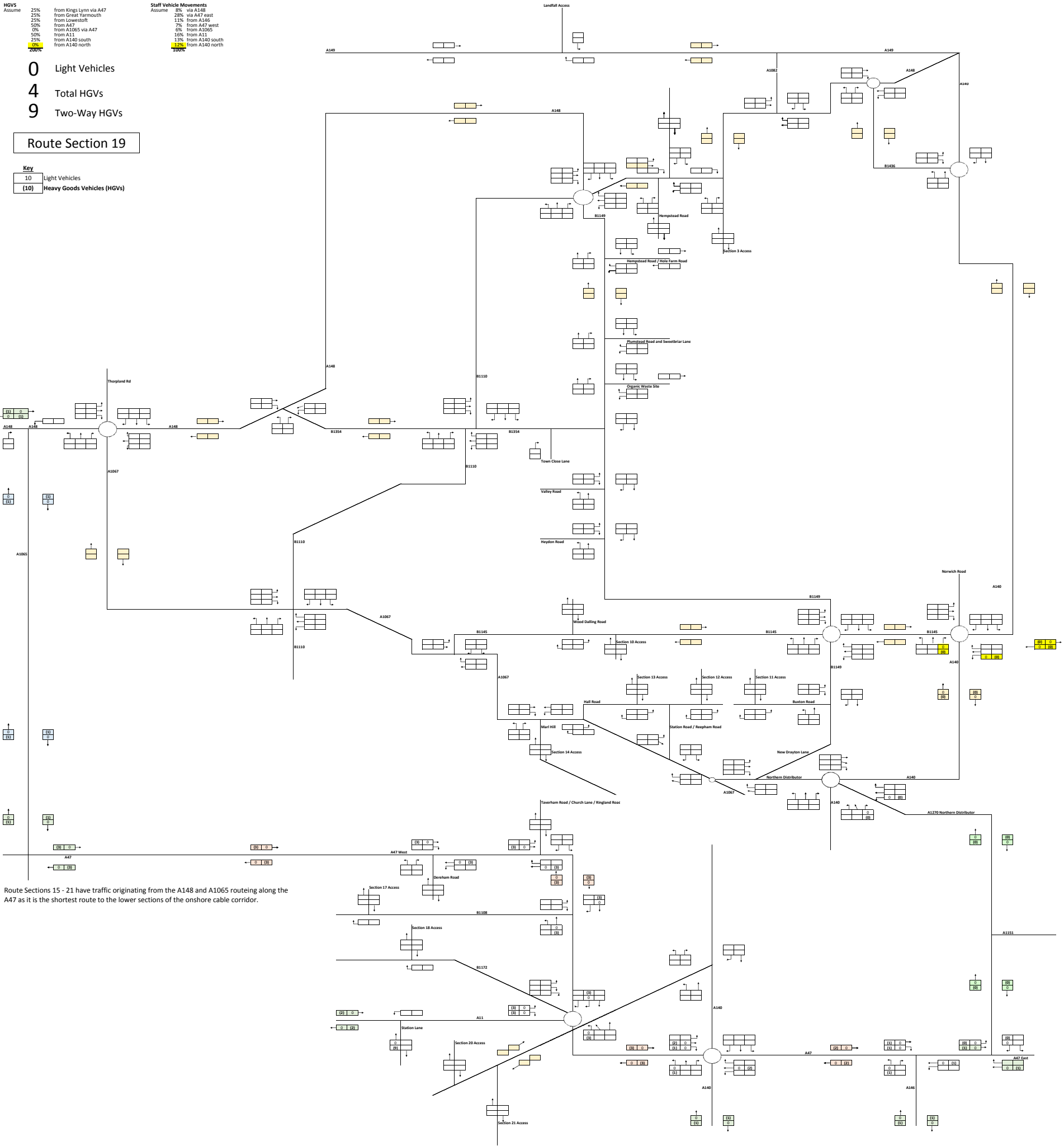

Route Sections 15 - 21 have traffic originating from the A148 and A1065 routing along the A47 as it is the shortest route to the lower sections of the onshore cable corridor.

HGVs	25%	from Kings Lynn via A47	Staff Vehicle Movements	28%	via A148
Assume	25%	from Great Yarmouth	Assume	11%	from A146
	25%	from Lowestoft		7%	from A47 west
	50%	from A47		6%	from A1065
	0%	from A1065 via A47		10%	from A11
	25%	from A140 south		13%	from A140 south
	25%	from A140 north		12%	from A140 north
	25%	from A140 north		25%	from A140 north

- 0 Light Vehicles
- 4 Total HGVs
- 9 Two-Way HGVs

Route Section 20

10	Light Vehicles
10	Heavy Goods Vehicles (HGVs)

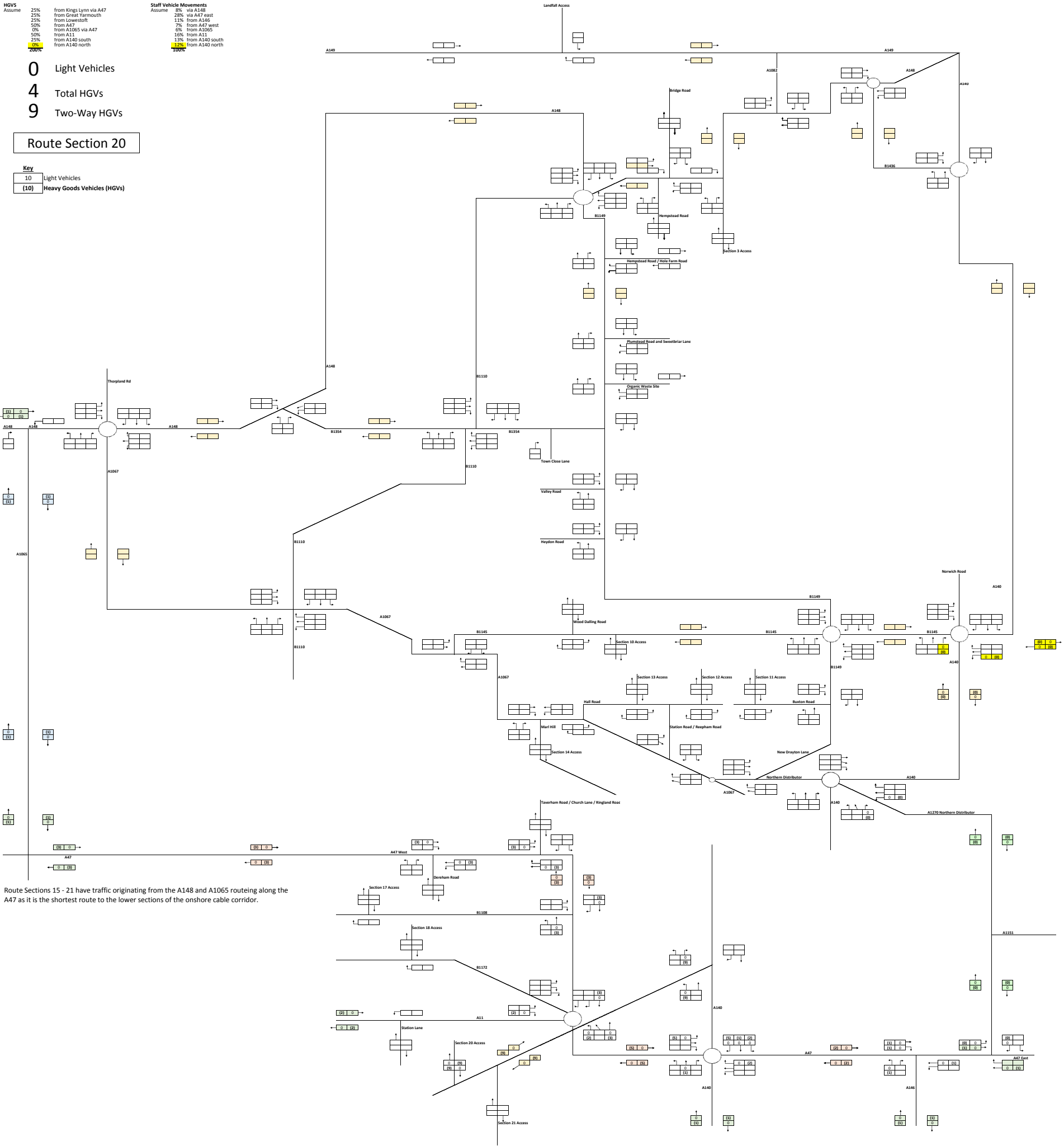

Route Sections 15 - 21 have traffic originating from the A148 and A1065 routing along the A47 as it is the shortest route to the lower sections of the onshore cable corridor.

HGVs		
Assume	25%	from Kings Lynn via A47
	25%	from Great Yarmouth
	25%	from Lowestoft
	50%	from A47
	0%	from A1065 via A47
	50%	from A11
	25%	from A140 south
	25%	from A140 north
	25%	from A140 north

Staff Vehicle Movements		
Assume	8%	via A148
	28%	via A47 east
	11%	from A146
	7%	from A47 west
	6%	from A1065
	16%	from A11
	13%	from A140 south
	12%	from A140 north
	12%	from A140 north

0 Light Vehicles
6 Total HGVs
13 Two-Way HGVs

Route Section 21

10	Light Vehicles
10	Heavy Goods Vehicles (HGVs)

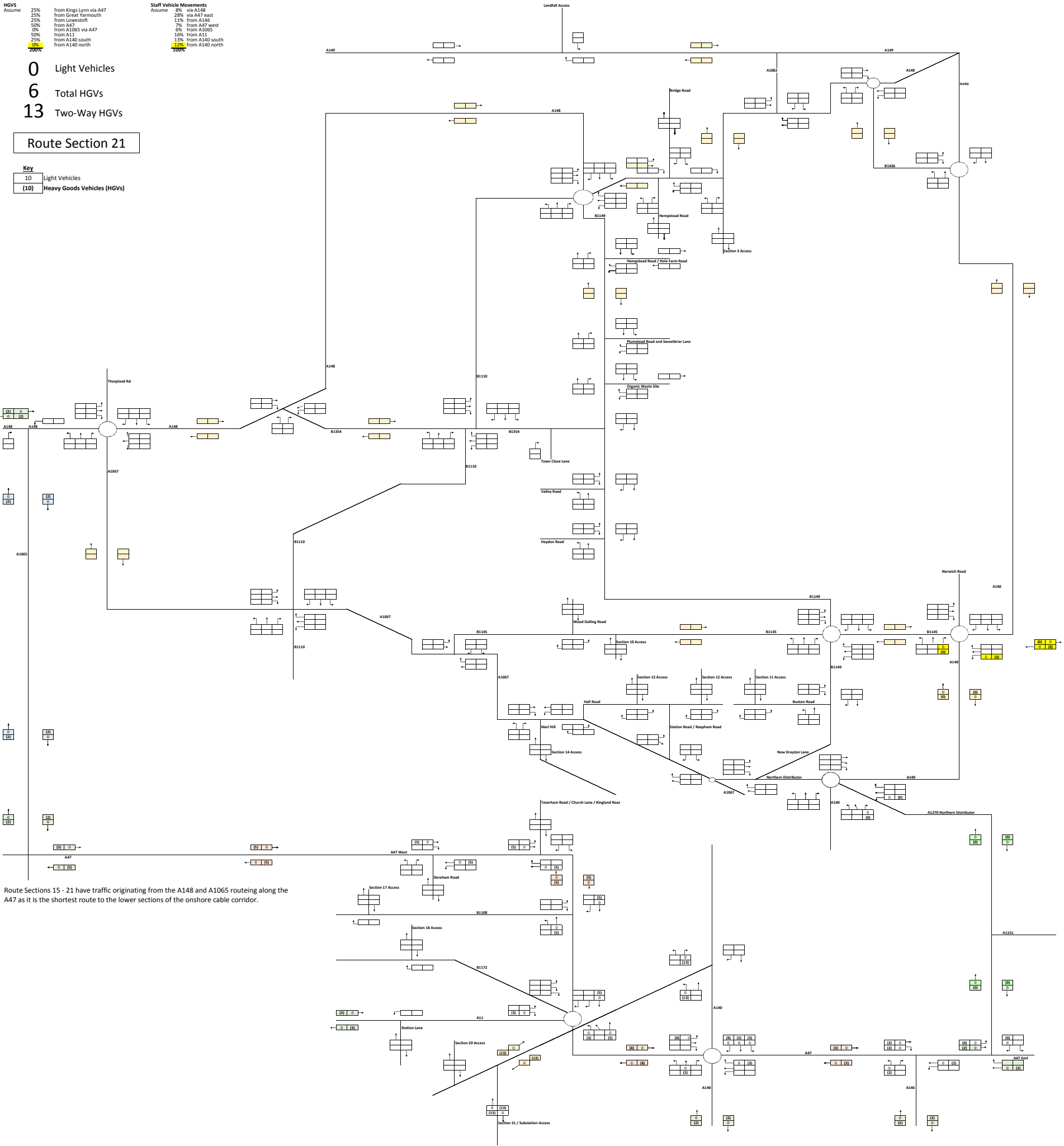



Route Sections 15 - 21 have traffic originating from the A148 and A1065 routing along the A47 as it is the shortest route to the lower sections of the onshore cable corridor.

Southern Group Total

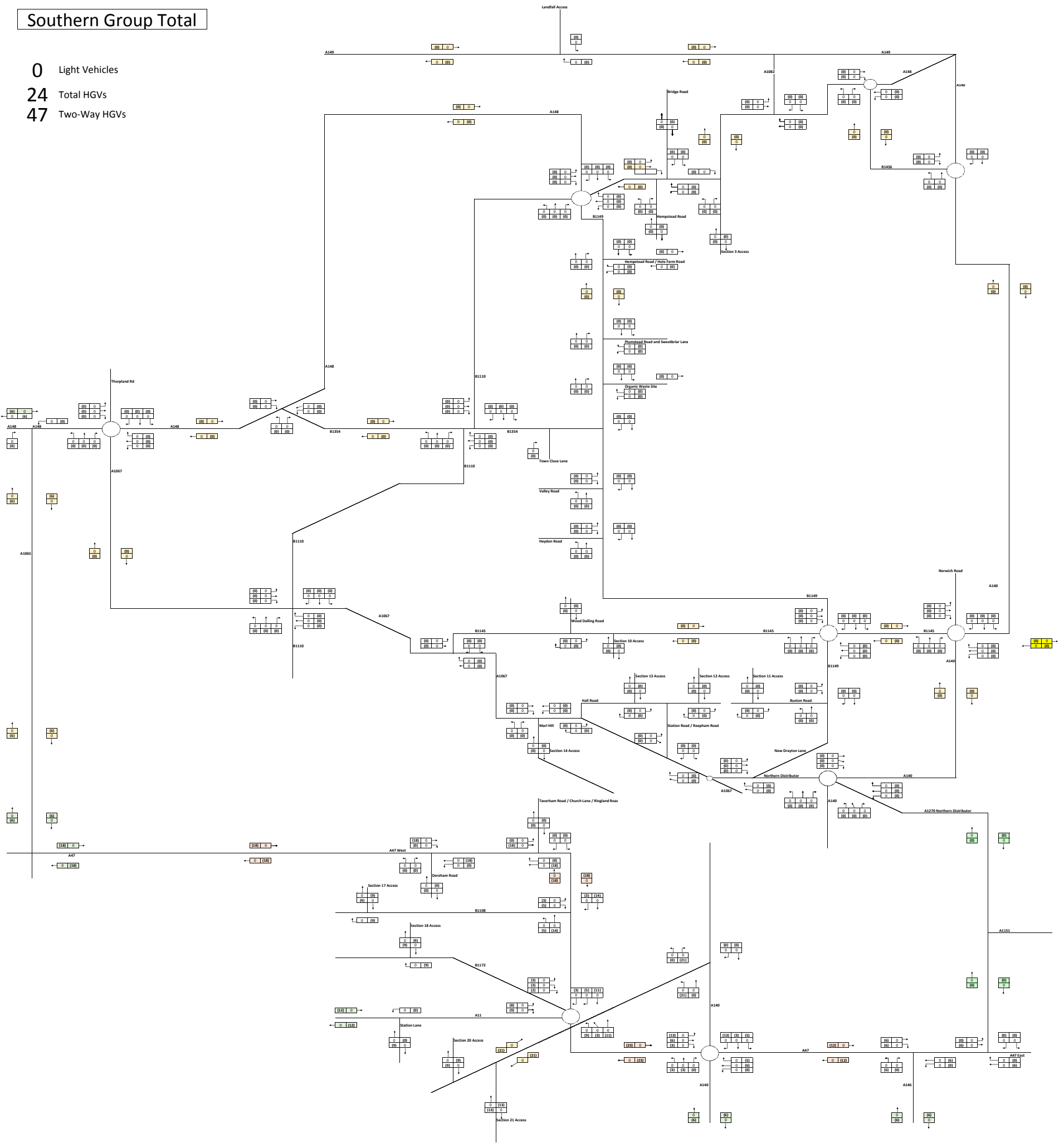
- 0 Light Vehicles
- 24 Total HGVs
- 47 Two-Way HGVs



HGVs Assume	25%	from Kings Lynn via A148	Staff Vehicle Movements Assume	8%	via A148
	25%	from Great Yarmouth		28%	via A47 east
	25%	from Lowestoft		11%	from A146
	50%	from A47		7%	from A47 west
	0%	from A1065		6%	from A1065
	50%	from A11		16%	from A11
25%	from A140 south	13%	from A140 south		
25%	from A140 north	12%	from A140 north		
25%		12%			

-  Light Vehicles
-  Total HGVs
-  Two-Way HGVs

Landfall

10	Light Vehicles
10	Heavy Goods Vehicles (HGVs)

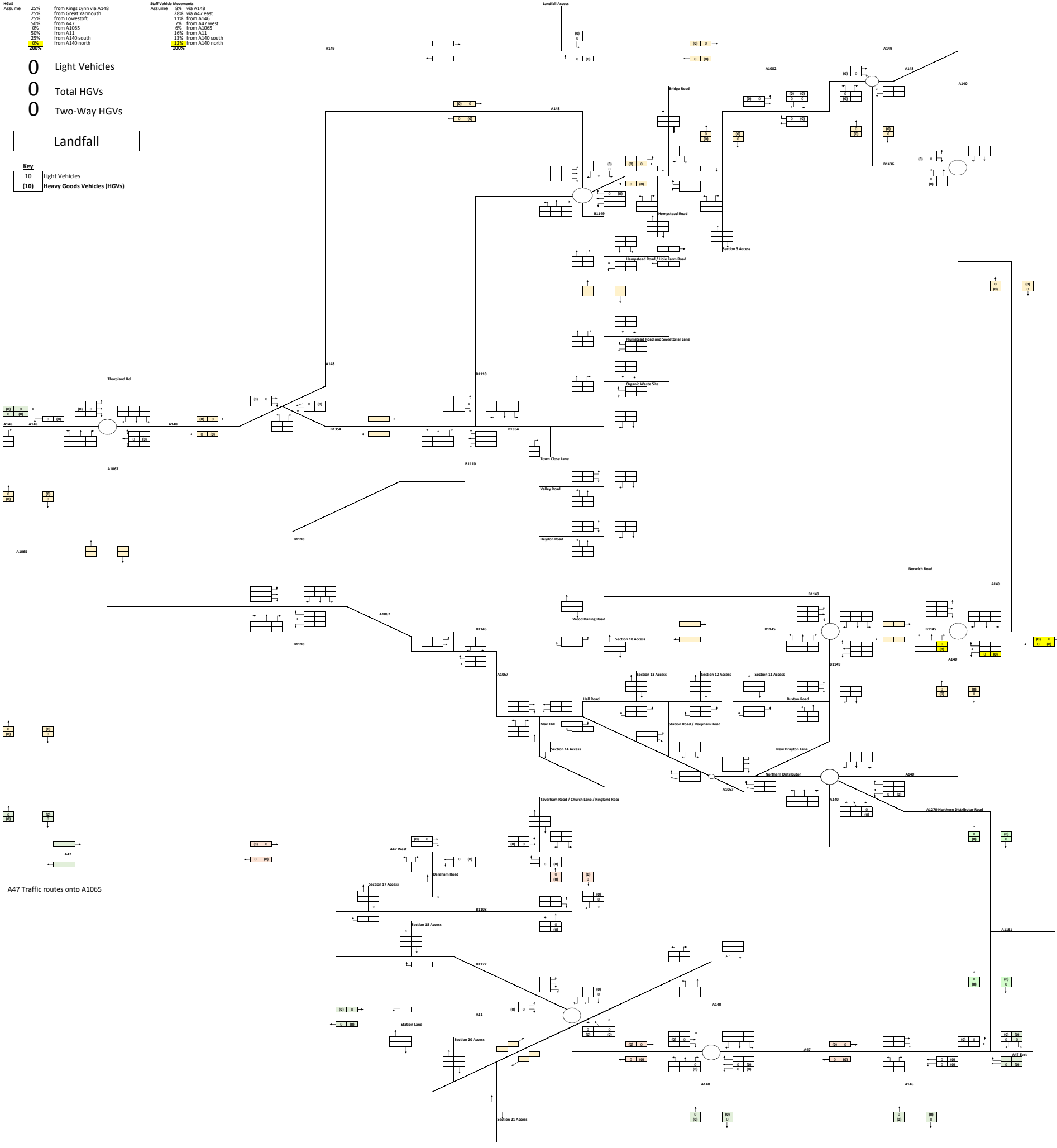

A47 Traffic routes onto A1065

HGVs Assume		Staff Vehicle Movements Assume	
25%	from Kings Lynn via A148	8%	via A148
25%	from Great Yarmouth	28%	via A47 east
25%	from Lowestoft	11%	from A146
50%	from A47	7%	from A47 west
0%	from A1065	6%	from A1065
50%	from A11	16%	from A11
25%	from A140 south	13%	from A140 south
25%	from A140 north	12%	from A140 north
25%		12%	

- 0 Light Vehicles
- 1 Total HGVs
- 1 Two-Way HGVs

HVAC Booster Station

Key	
10	Light Vehicles
10	Heavy Goods Vehicles (HGVs)

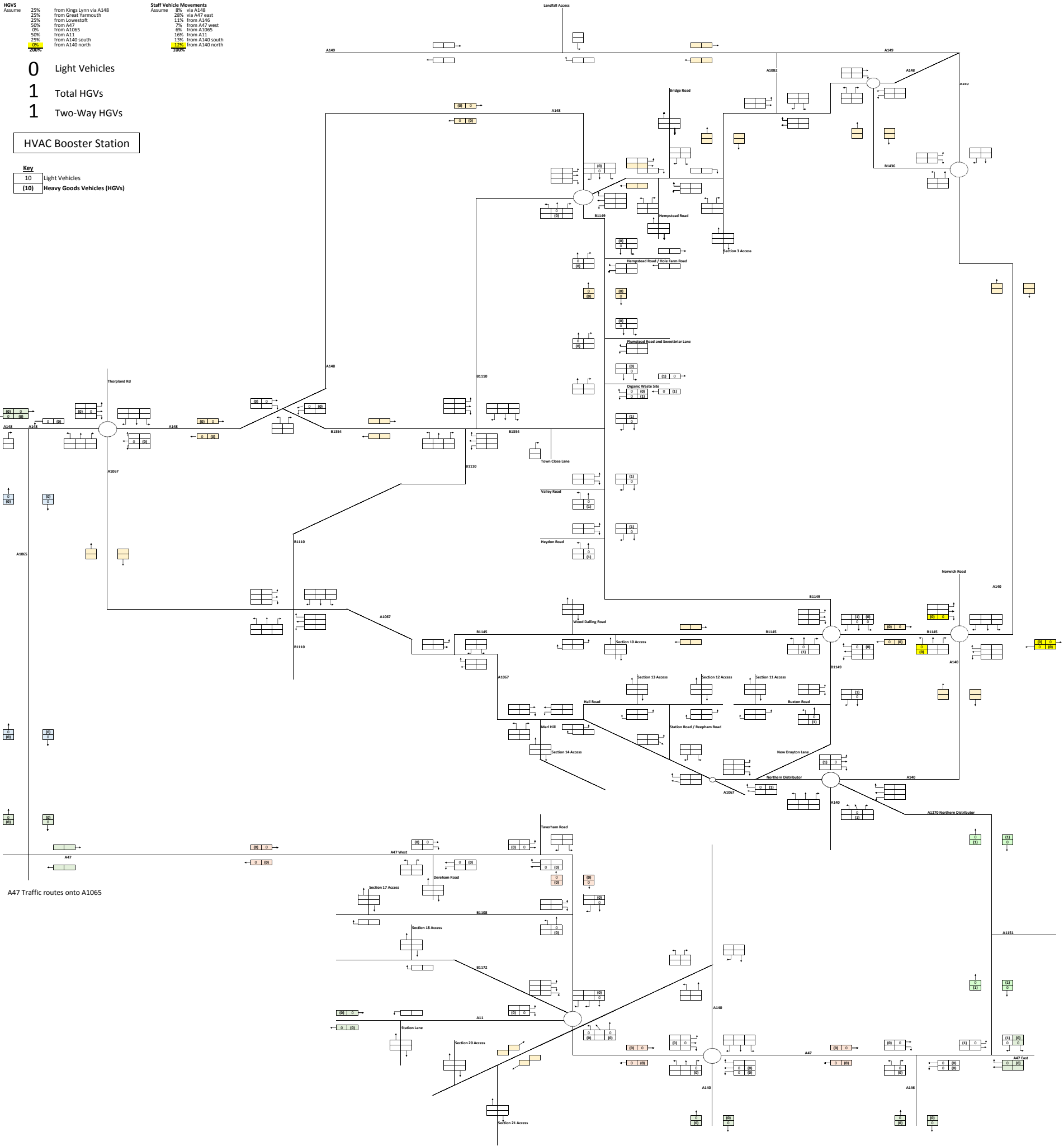

A47 Traffic routes onto A1065

HGVs	25%	from Kings Lynn via A47	Staff Vehicle Movements	28%	via A148
Assume	25%	from Great Yarmouth	Assume	11%	from A146
	25%	from Lowestoft		7%	from A47 west
	50%	from A47		6%	from A105
	0%	from A105 via A47		10%	from A11
	50%	from A11		13%	from A140 south
	25%	from A140 south		12%	from A140 north
	25%	from A140 north		100%	
	200%				

- 0** Light Vehicles
- 1** Total HGVs
- 3** Two-Way HGVs

HVAC Substation

Key	
10	Light Vehicles
10	Heavy Goods Vehicles (HGVs)

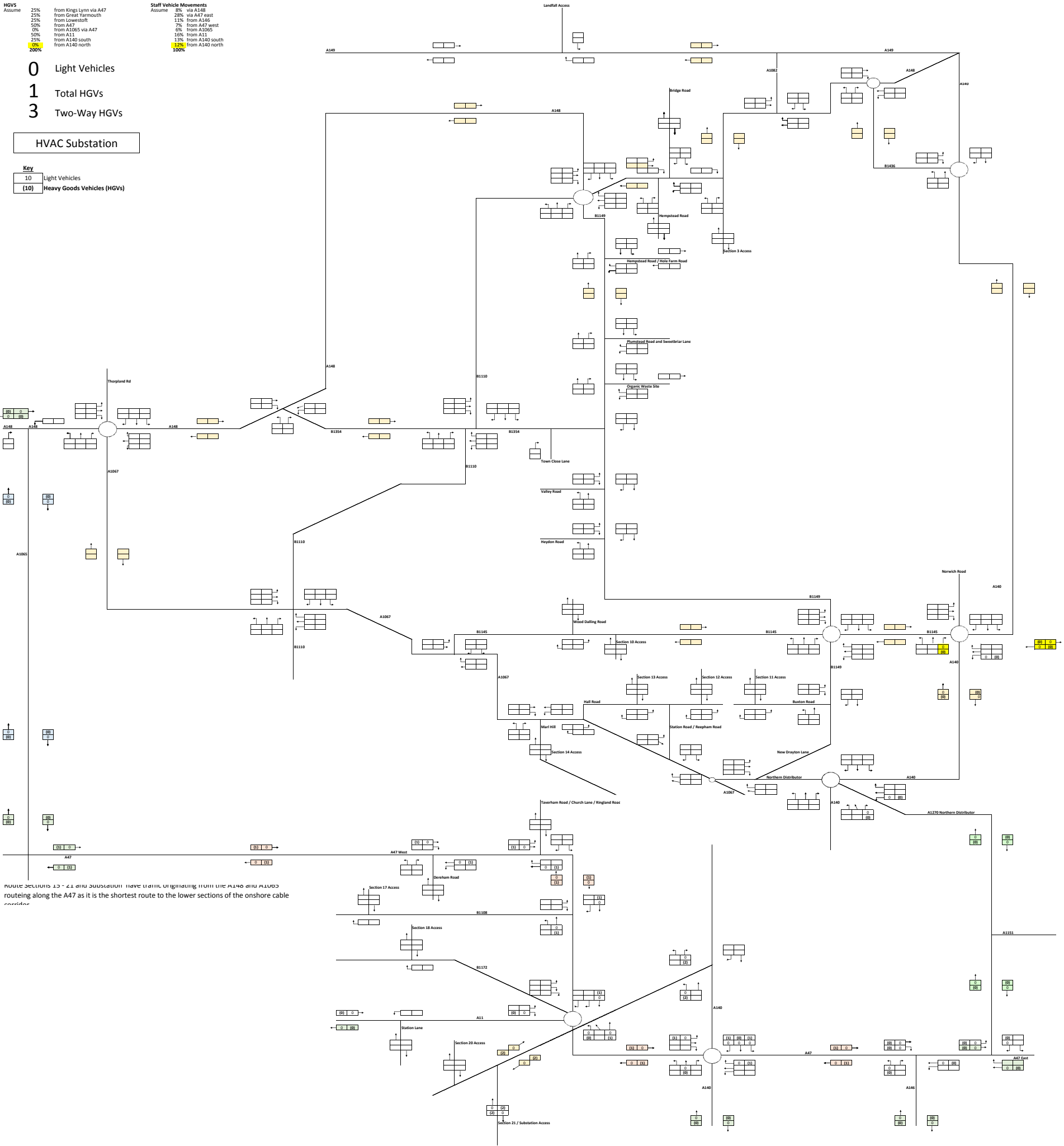

routing along the A47 as it is the shortest route to the lower sections of the onshore cable

Hourly Construction HGW Flows - Sensitivity Scenario
Northern Group + Landfill + Booster Station + Substation

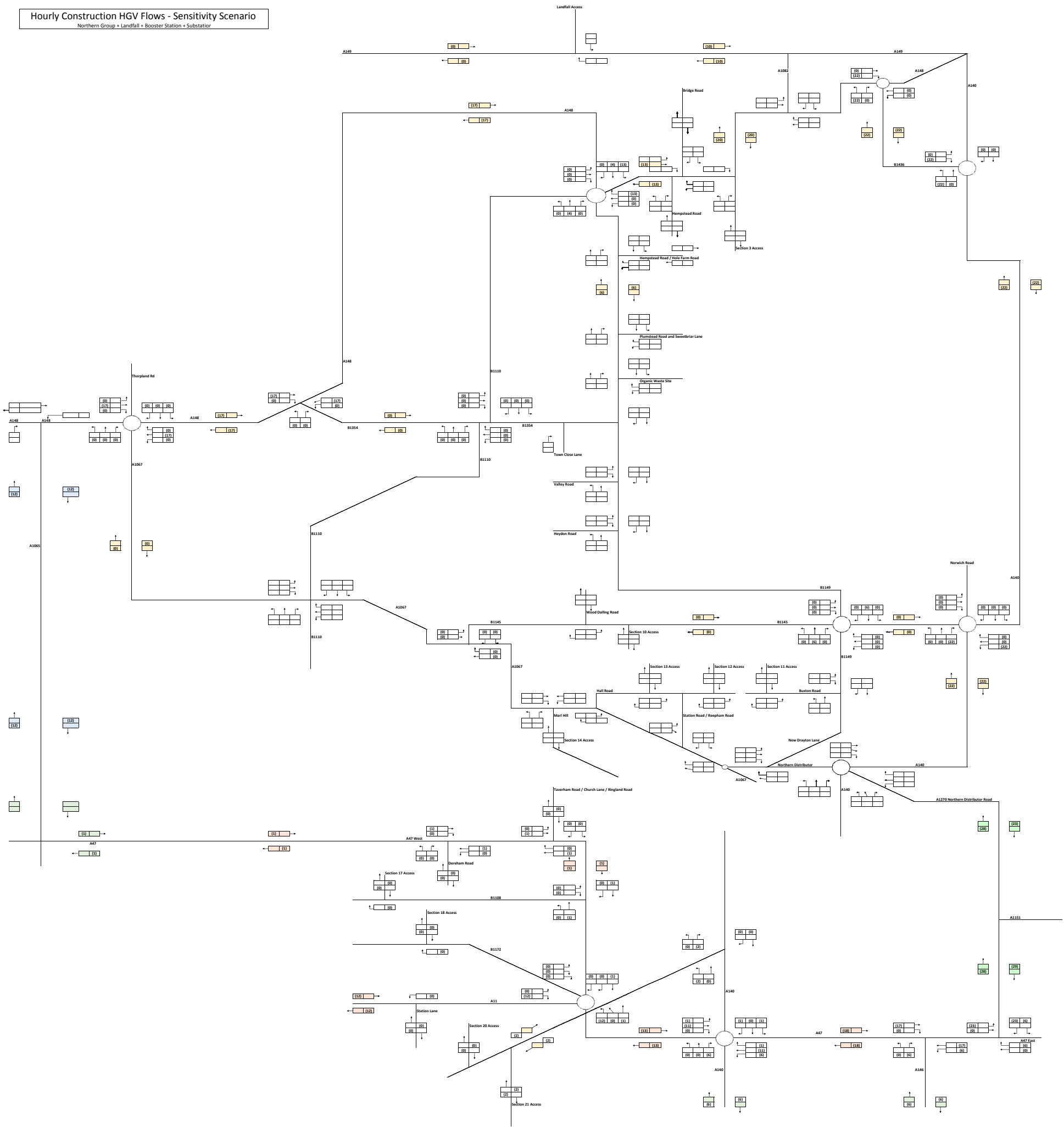

Hourly Construction HGV Flows - Sensitivity Scenario

Middle (northern) Group + Landfill + Booster Station + Substation

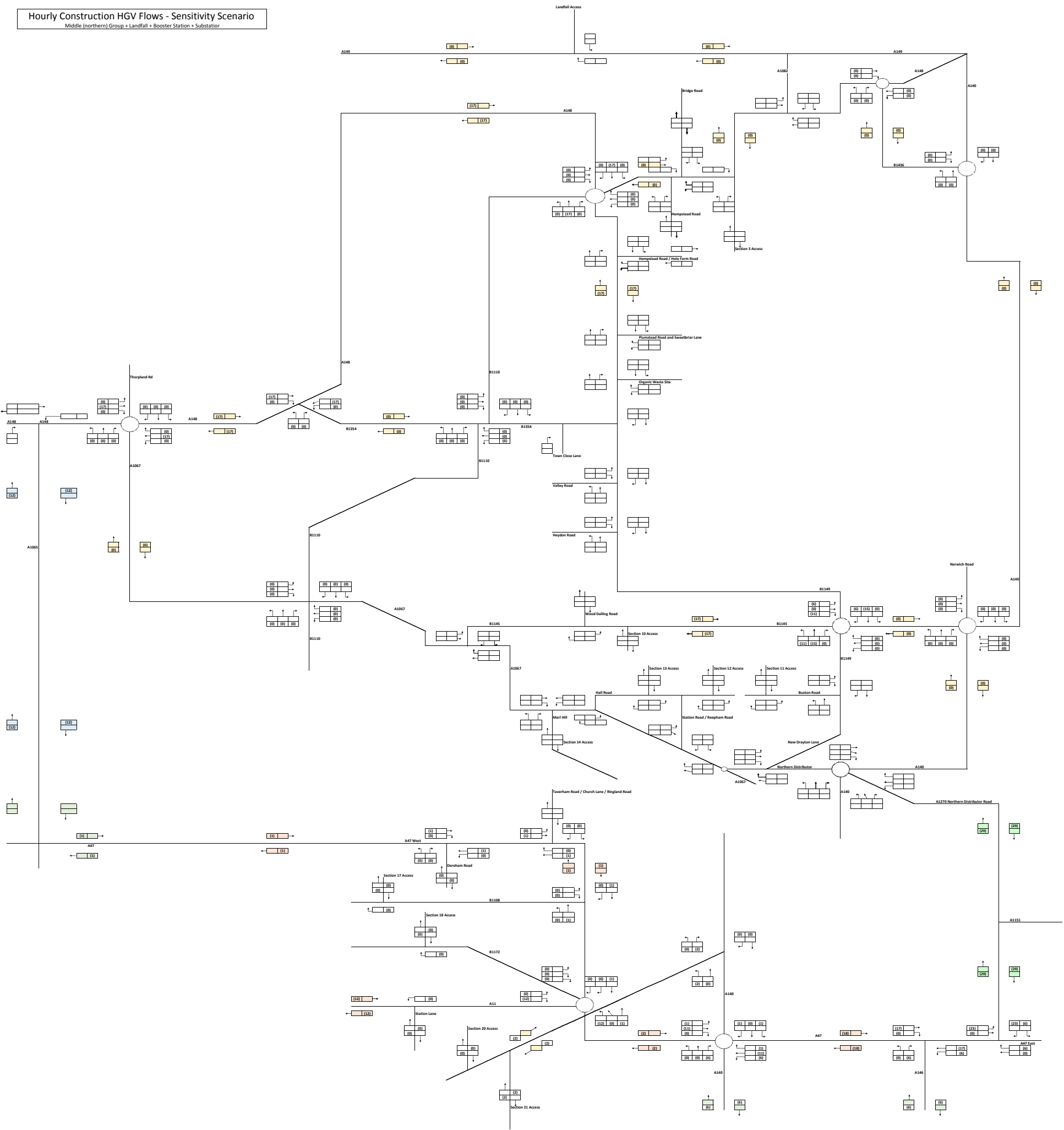

Hourly Construction HGV Flows - Sensitivity Scenario
Middle (southern) Group + Landfill + Booster Station + Substation

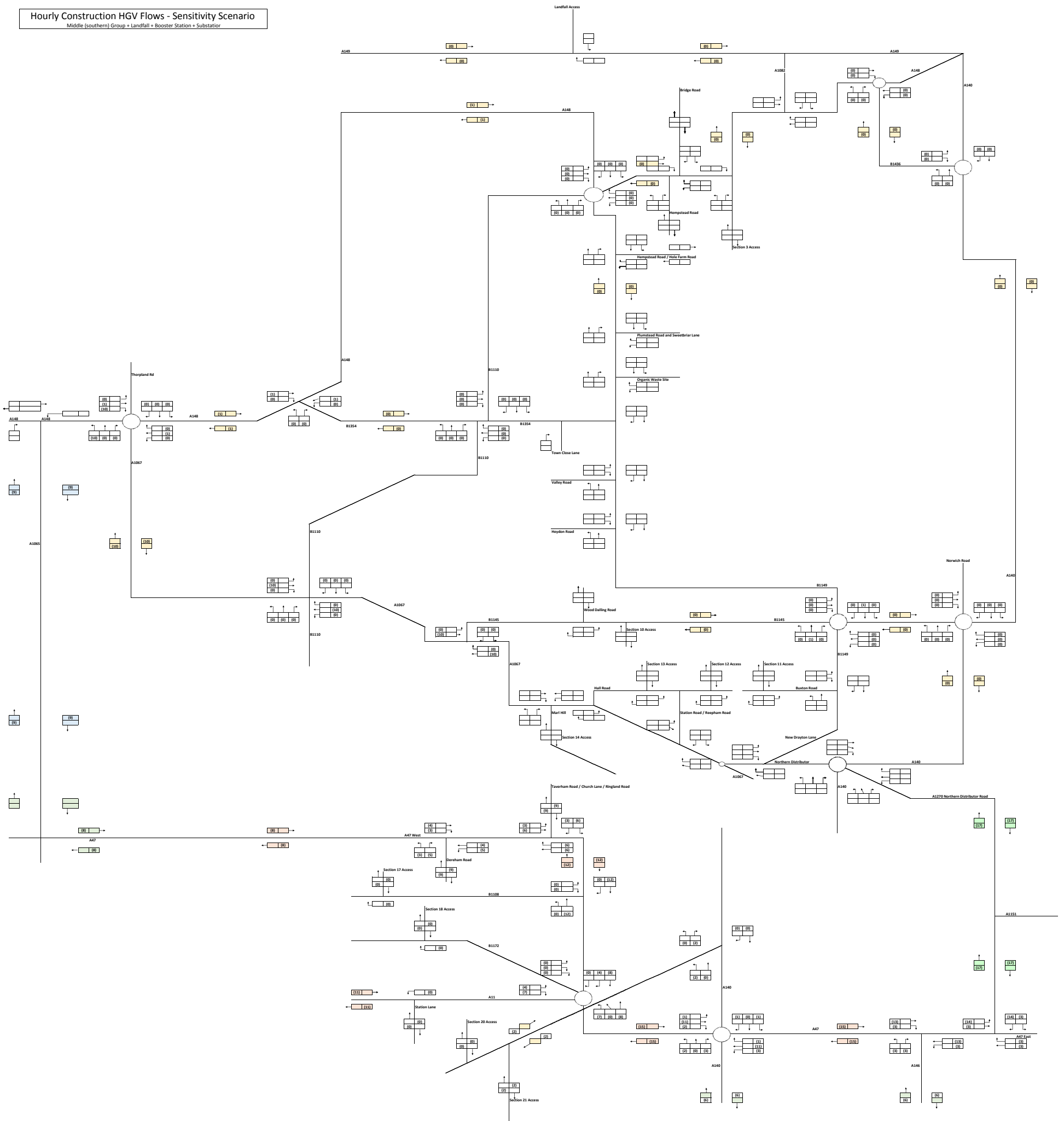

Hourly Construction HGW Flows - Sensitivity Scenario

Southern Group + Landfill + Booster Station + Substation

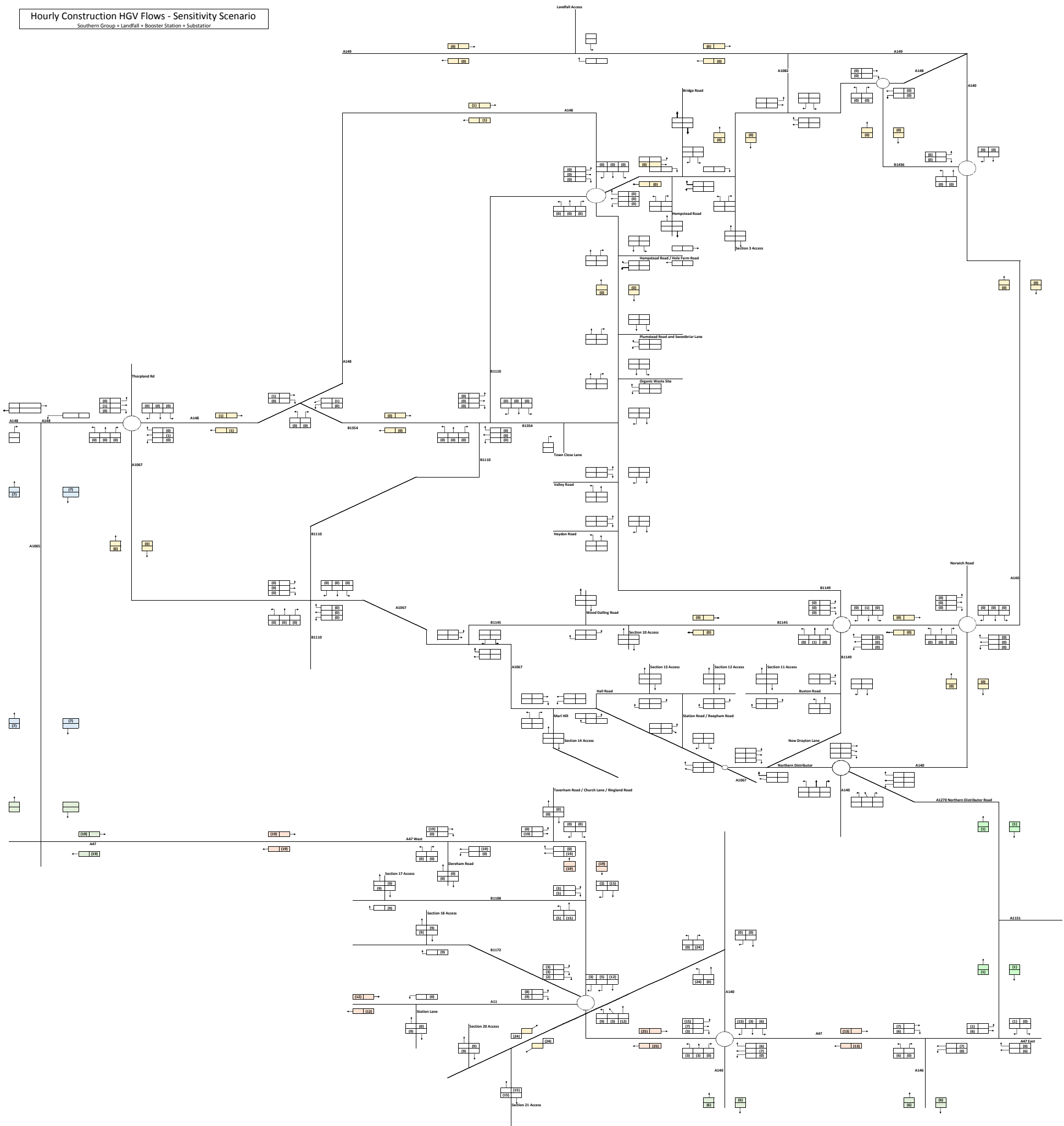

Traffic Flow Diagrams

12hr Total Construction Traffic

2017 Observed Traffic Flows

07:00-19:00

- Key**
10 Total Vehicles
(10) Heavy Goods Vehicles (HGVs)

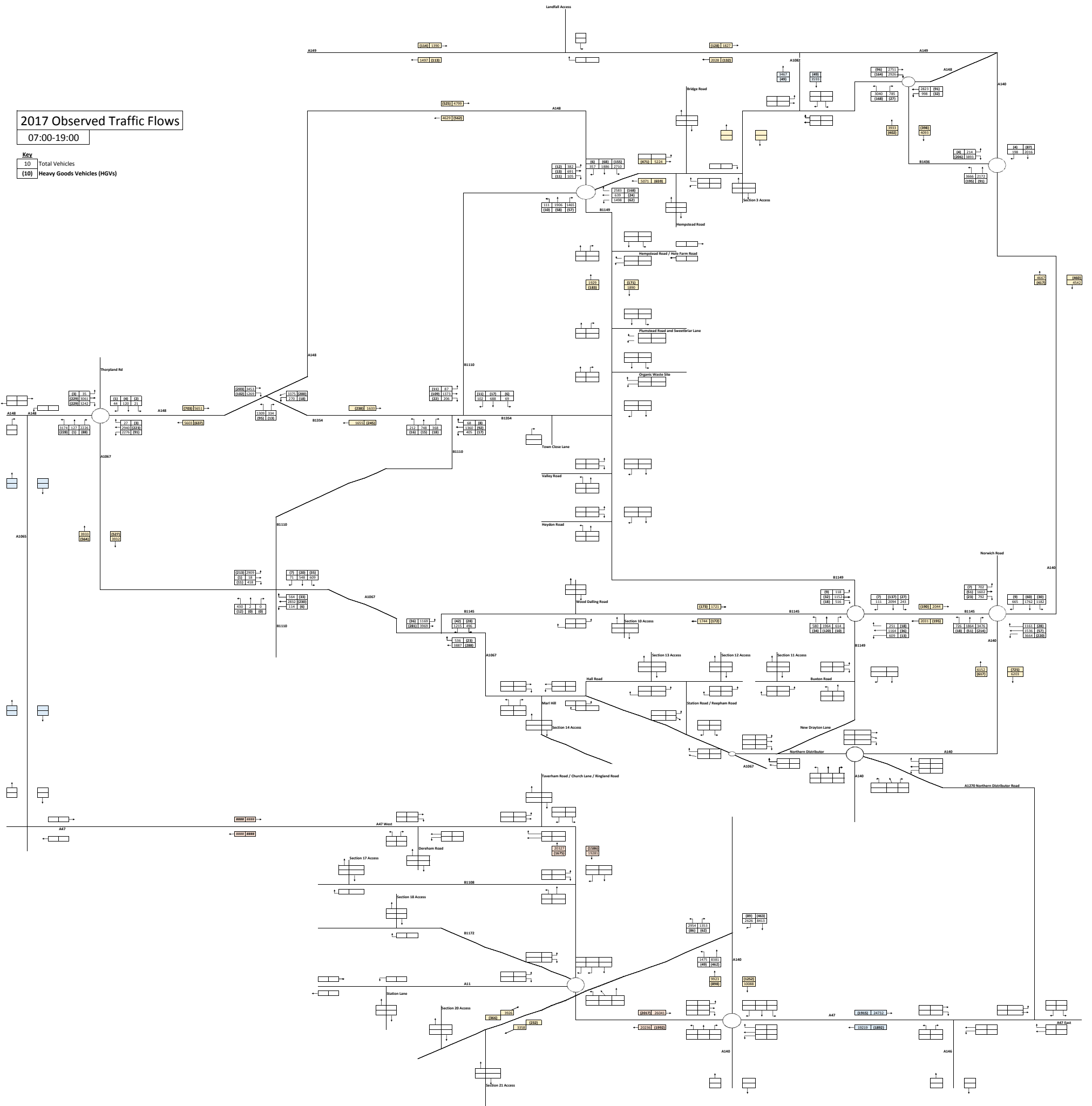

TEMPRO

Average Weekday

Trunk	1.10	growth 2017-2022
Principal	1.00	growth 2017-2022
Minor	1.00	growth 2017-2022

2022 Base Traffic Flows

07:00-19:00

Key

10	Total Vehicles
(10)	Heavy Goods Vehicles (HGVs)

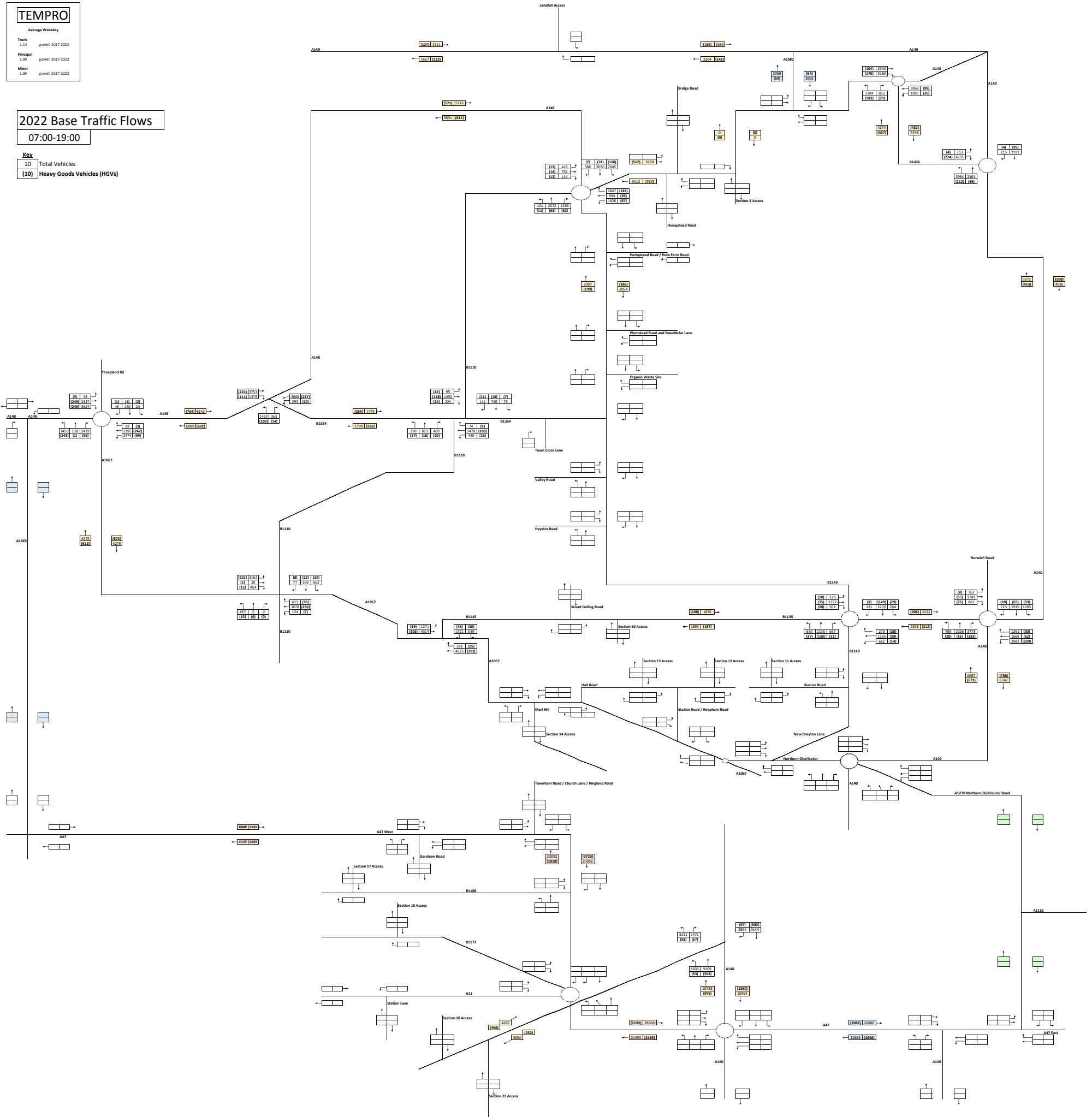

Tables Linked to Construction Vehicle Movements Spreadsheet

Route Section	Description	12hr Vehicle Flows			Phase
		Total	HGV	Lights	
1	Landfall to Holgate Hill	228	105	123	1
2	Holgate Hill to woodland north east of High Kelling	173	96	77	1
3	Woodland northeast of High Kelling to woodland south of Church Road	223	95	128	1
4	Woodland south of Church Road to woodland south and east of School Lane	163	94	69	1
5	Woodland east of School Lane to Plumstead Road	163	94	69	1
6	Plumstead Road to the B1149	233	106	128	2
7	B1149 to land South of Town Close Lane	173	96	77	-
8	Land south of Town Close Lane to woodland north of Reepham Road	260	94	167	2
9	Land north of Reepham Road to woodland north of Reepham	221	94	128	2
10	Woodland north of Reepham to woodland at Booton Common	212	96	116	2
11	Woodland east of Reepham to The Grove	193	97	96	2
12	The Grove to woodland south of Church Farm Lane	163	94	69	3
13	Woodland south of Church Farm Lane to River Wensum	192	96	96	3
14	River Wensum to woodland south west of Ringland	277	95	182	3
15	Woodland south west of Ringland to A47	173	101	72	3
16	A47 to Bawburgh Road	224	97	128	3
17	Bawburgh Road to woodland west of Little Melton	241	94	147	4
18	Woodland west of Little Melton to A11	316	96	221	4
19	A11 to woodland north west of Swardeston	191	95	96	4
20	Woodland north west of Swardeston to B1113	203	95	108	4
21	B1113 to end of cable route	267	140	128	4
Landfall	Landfall	15	5	10	
Booster Station	Booster Station	46	12	34	
Converter / Sub Station	Converter / Sub Station	111	29	82	
Total:		4,661	2,116	2,545	4,661

HGVs	10%	from Kings Lynn via A148
Assume	5%	from Great Yarmouth
	5%	from Lowestoft
	35%	from A47
	0%	from A1065
	35%	from A11
	10%	from A140 south
	0%	from A140 north
	100%	

Staff Vehicle Movements	
Assume	8% via A158
	20% via A47 east
	11% from A140
	7% from A47 west
	0% from A1065
	10% from A11
	33% from A140 south
	100%

123 Light Vehicles
105 Total HGVs

12hr Total Construction Traffic
Route Section 1

Key	
10	Total Vehicles
(10)	Heavy Goods Vehicles (HGVs)

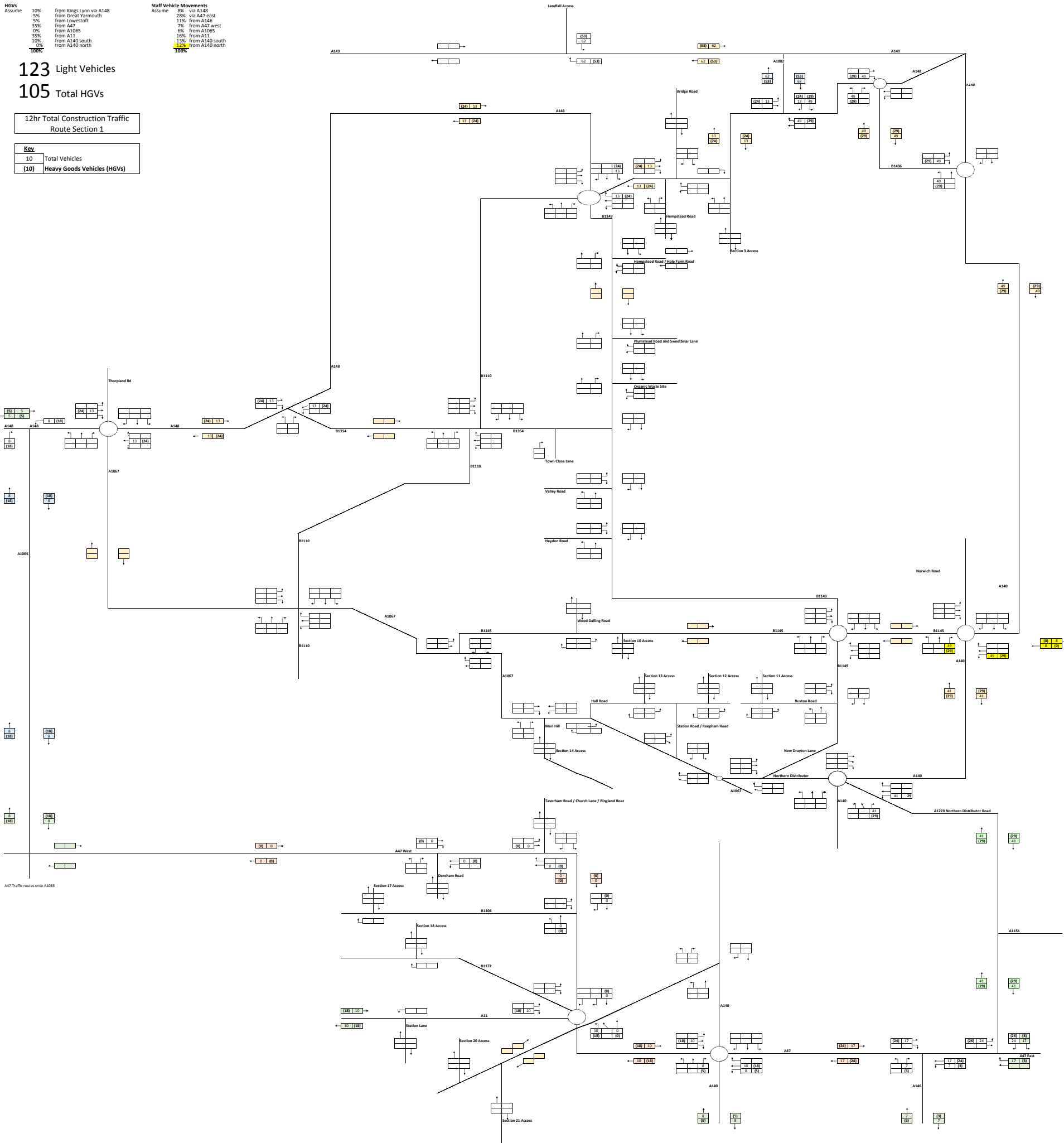

HGVs	10%	from Kings Lynn via A148	Staff Vehicle Movements	8%	via A148
Assume	5%	from Great Yarmouth	Assume	28%	via A27 east
	5%	from Lowestoft		11%	from A146
	35%	from A27		7%	from A27 west
	0%	from A1065		6%	from A1065
	35%	from A11		16%	from A11
	10%	from A140 south		13%	from A140 south
	0%	from A140 north		12%	from A140 north
	0%			10%	

77 Light Vehicles

96 Total HGVs

12hr Total Construction Traffic
Route Section 2

Key	10	Total Vehicles
	(10)	Heavy Goods Vehicles (HGVs)

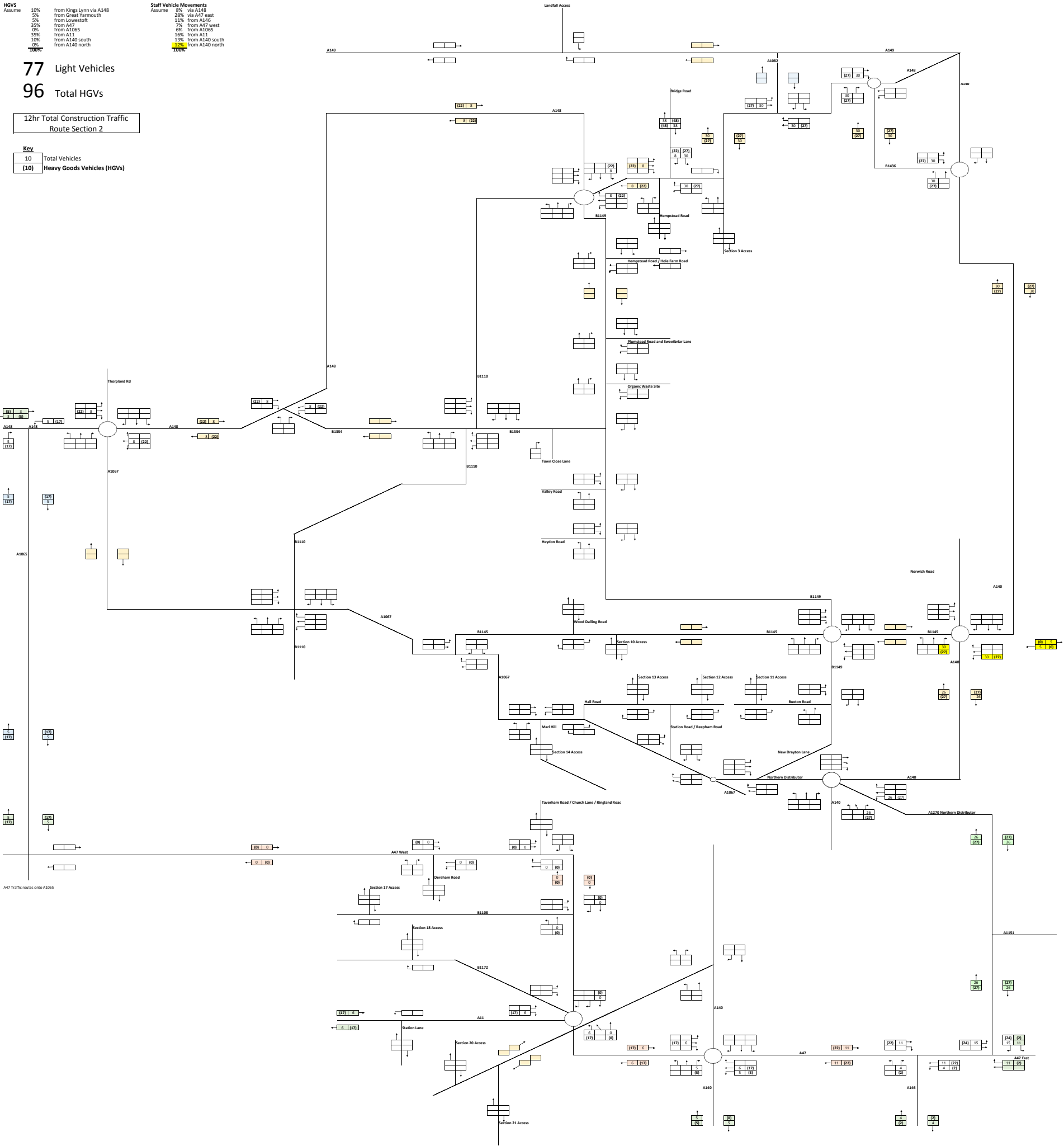

HGVs	Assume	10%	from Kings Lynn via A148
		5%	from Great Yarmouth
		5%	from Lowestoft
		35%	from A47
		0%	from A1065
		35%	from A11
		10%	from A140 south
		0%	from A140 north
		20%	from A140 north
		10%	from A140 north

Staff Vehicle Movements	Assume	8%	via A148
		28%	via A47 east
		11%	from A146
		7%	from A47 west
		6%	from A1065
		16%	from A11
		13%	from A140 south
		12%	from A140 north
		20%	from A140 north

128 Light Vehicles

95 Total HGVs

12hr Total Construction Traffic
Route Section 3

Key
10 Total Vehicles
(10) Heavy Goods Vehicles (HGVs)

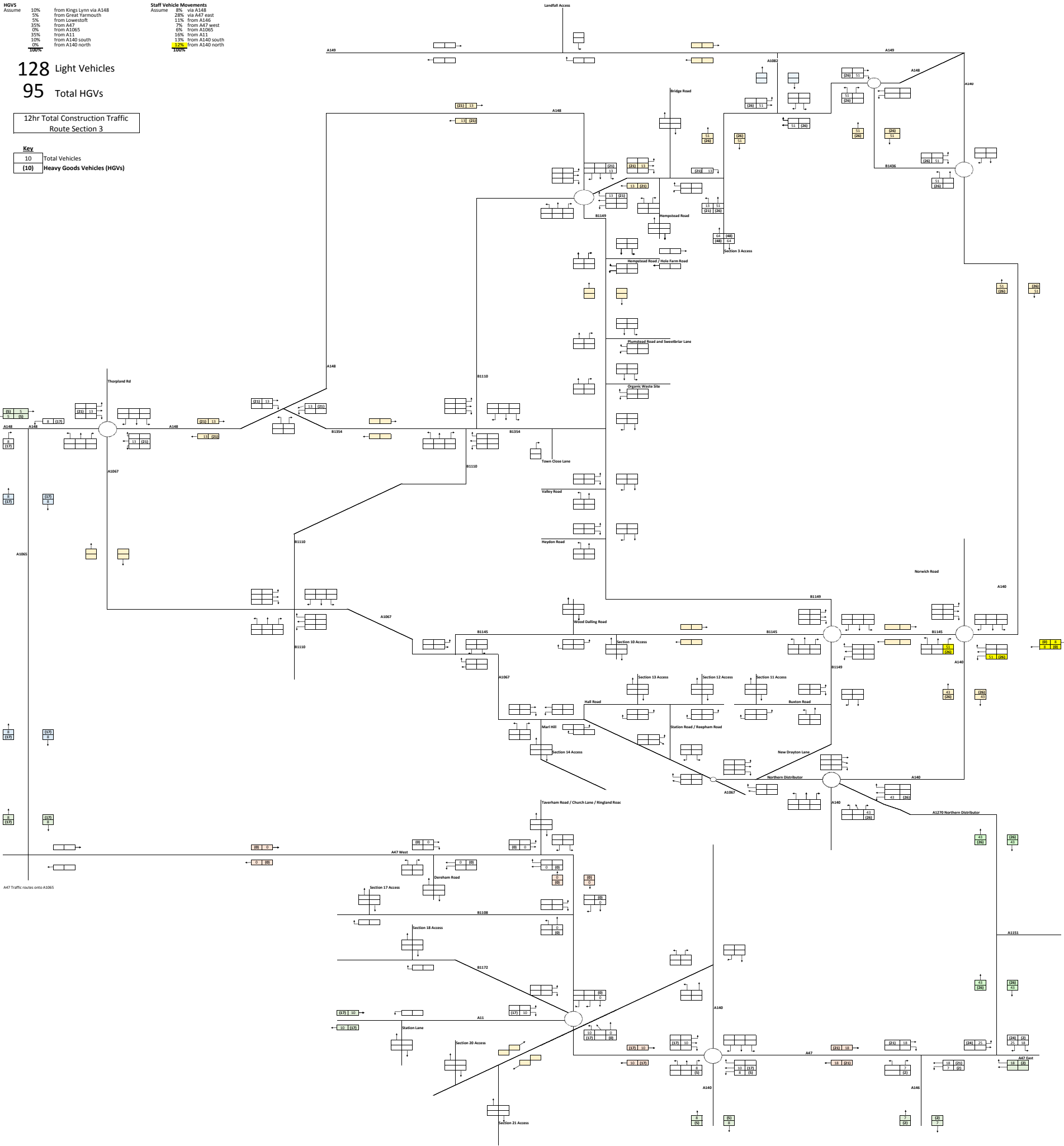

A47 Traffic routes onto A1065

HGVs		
Assume	10%	from Kings Lynn via A148
	5%	from Great Yarmouth
	0%	from Lowestoft
	35%	from A47
	0%	from A1065
	35%	from A11
	30%	from A140 south
	0%	from A140 north
TOTAL		

Staff Vehicle Movements		
Assume	8%	via A148
	28%	via A47 east
	11%	from A146
	7%	from A47 west
	6%	from A1065
	16%	from A11
	13%	from A140 south
	12%	from A140 north
TOTAL		

69 Light Vehicles
94 Total HGVs

12hr Total Construction Traffic
Route Section 4

Key
10 Total Vehicles
(10) Heavy Goods Vehicles (HGVs)

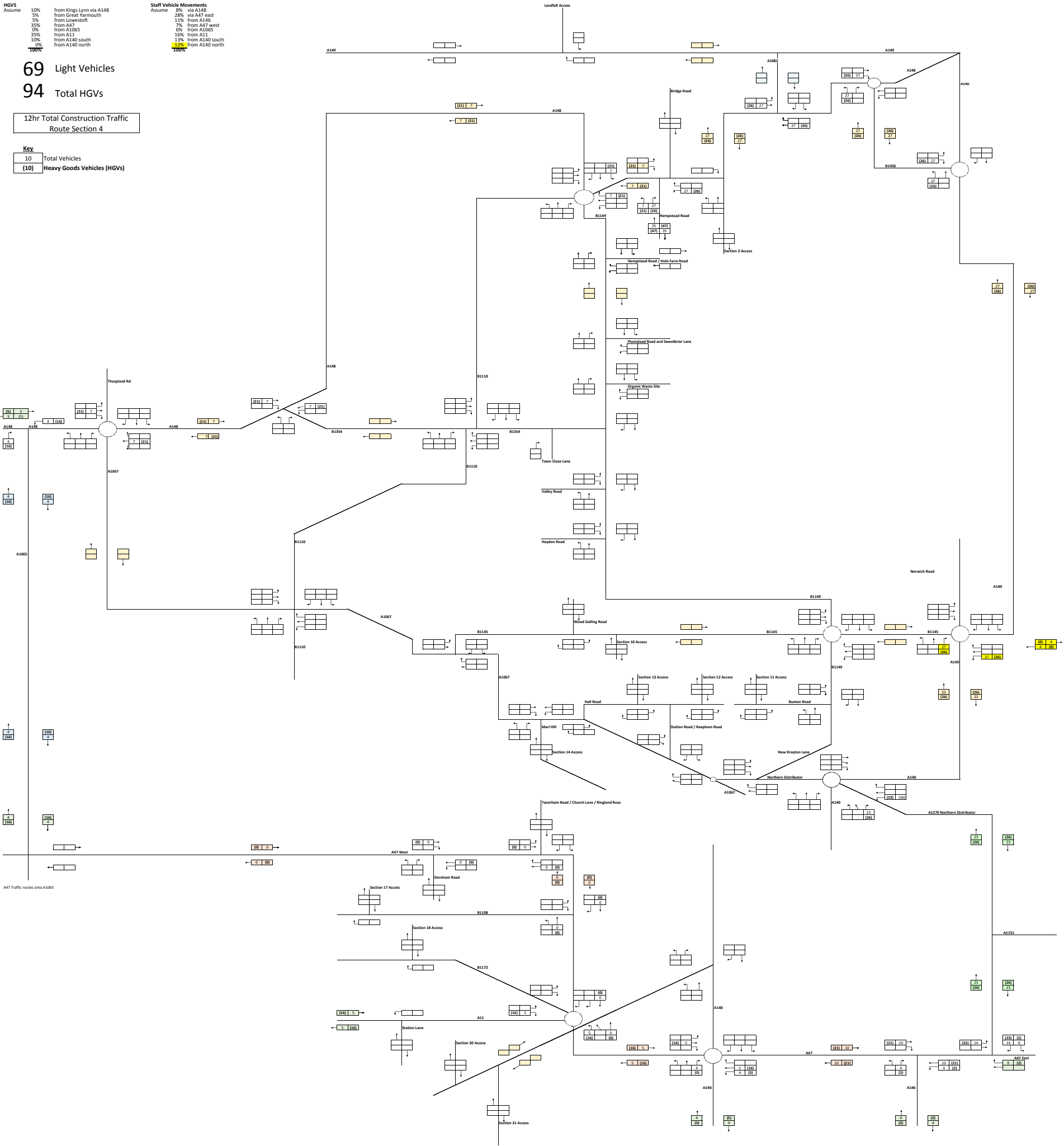

HGVs		Staff Vehicle Movements	
Assume	10%	Assume	8%
	from Kings Lynn via A148		via A148
	5%		28%
	from Great Yarmouth		via A27 east
	5%		11%
	from Lowestoft		from A146
	35%		7%
	from A27		from A27 west
	0%		6%
	from A1065		16%
	35%		from A11
	from A11		13%
	10%		from A140 south
	from A140 south		12%
	0%		from A140 north
	0%		10%

69 Light Vehicles
94 Total HGVs

12hr Total Construction Traffic
Route Section 5

Key
10 Total Vehicles
10 Heavy Goods Vehicles (HGVs)

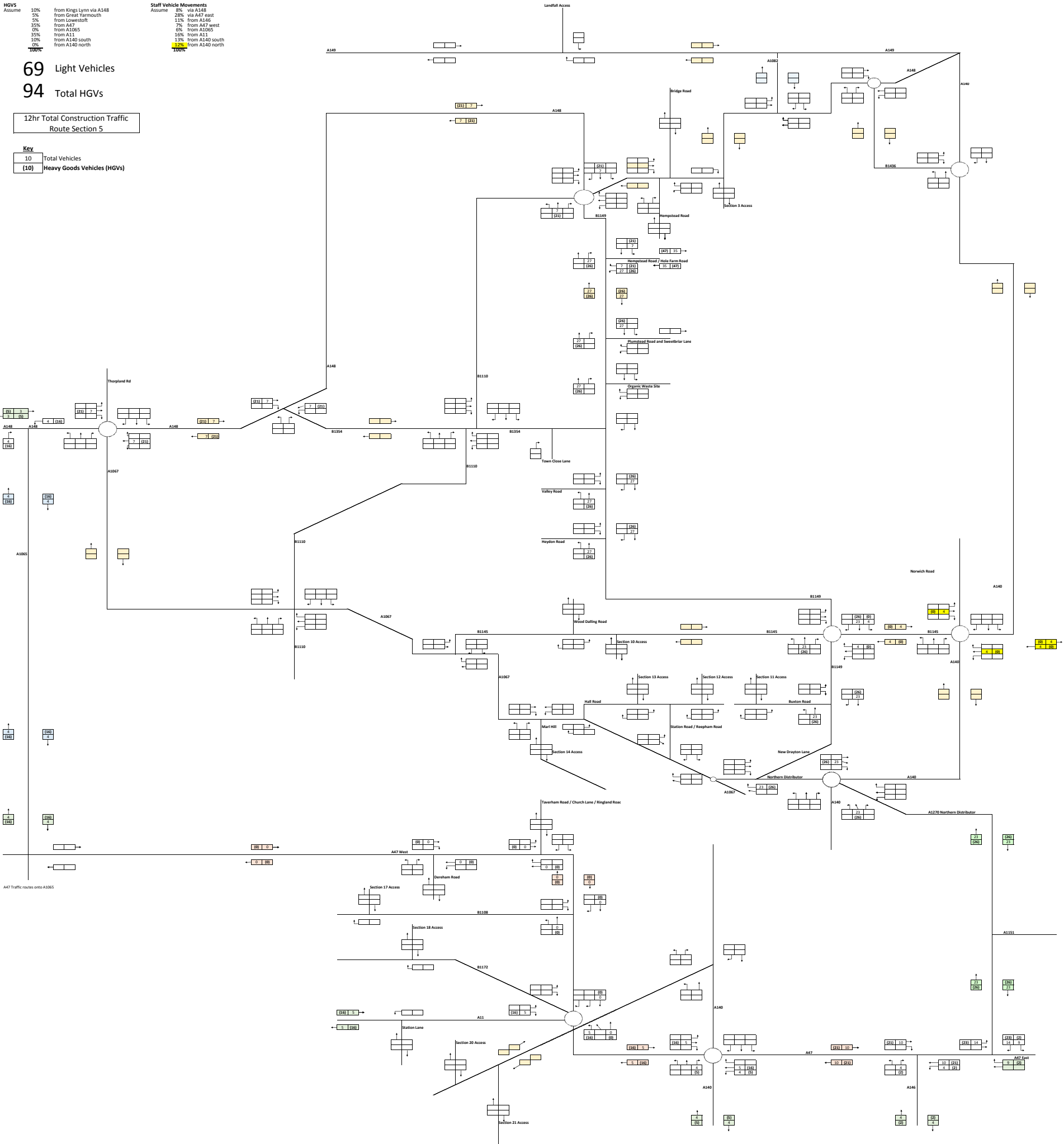

12hr Total Construction Traffic
Phase 1 Total

465 Light Vehicles

484 Total HGVs

949 Total Vehicles

Key
10 Total Vehicles
10 Heavy Goods Vehicles (HGVs)

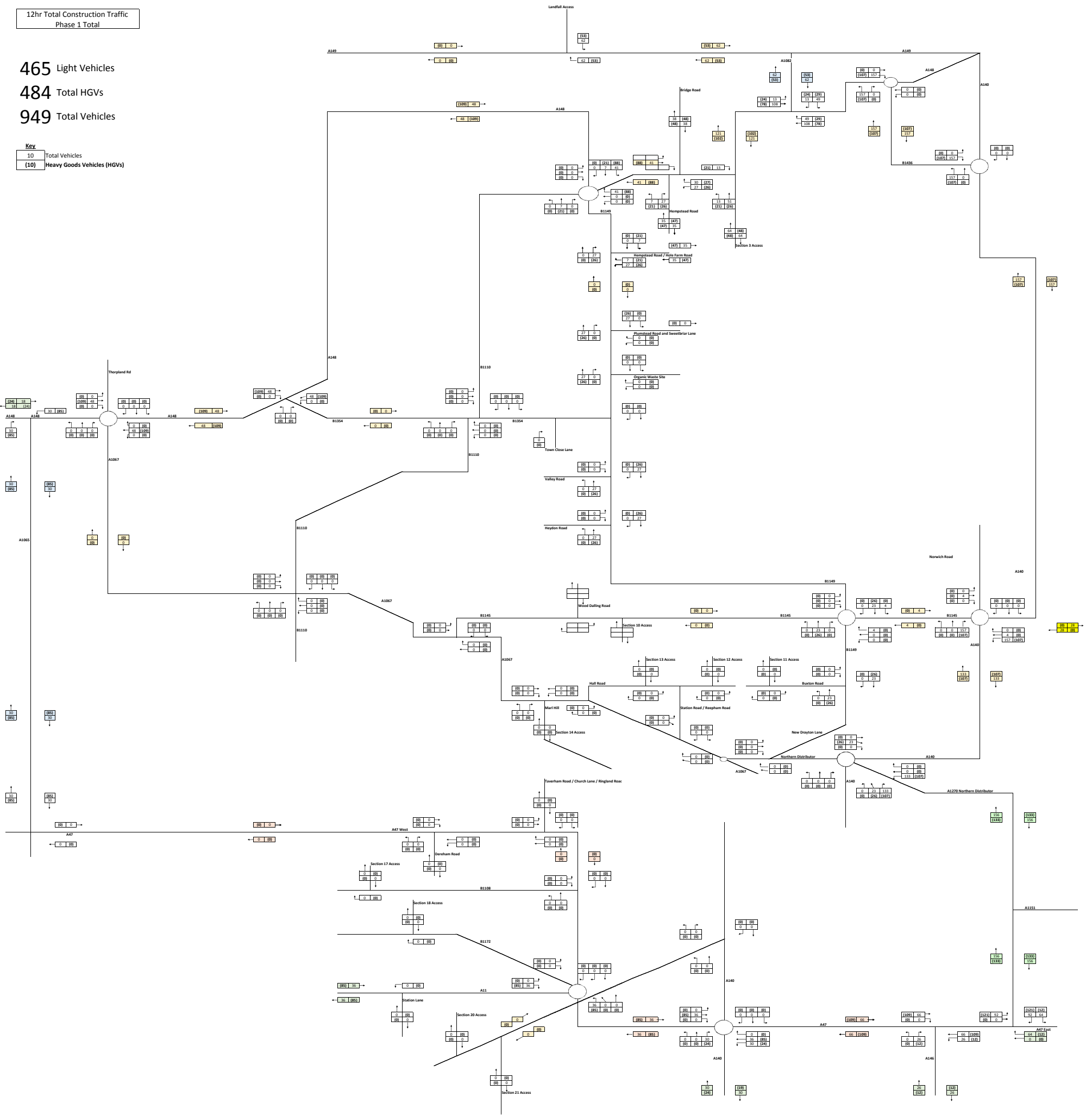

HGVs		Staff Vehicle Movements	
Assume	10%	Assume	8%
	from Kings Lynn via A148		via A148
	5%		28% via A47 east
	from Great Yarmouth		11% from A146
	0%		7% from A47 west
	35% from A105		6% from A105
	0%		16% from A11
	35% from A11		3% from A140 south
	30% from A140 south		12% from A140 north
	0%		12%
	100%		100%

128 Light Vehicles
106 Total HGVs

12hr Total Construction Traffic
Route Section 6

Key	
10	Total Vehicles
(10)	Heavy Goods Vehicles (HGVs)

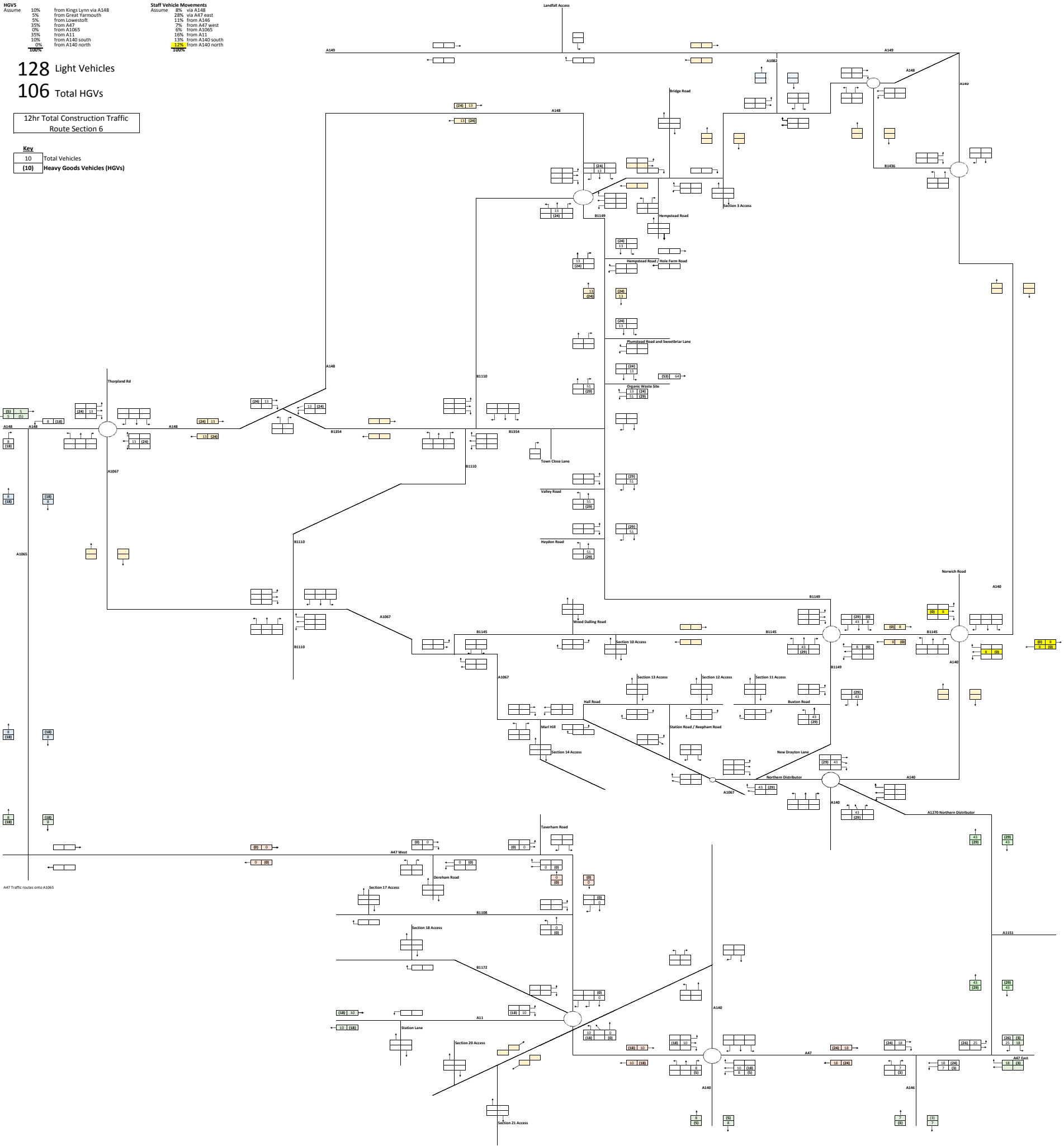

HGVs		
Assume	10%	from Kings Lynn via A148
	5%	from Great Yarmouth
	5%	from Lowestoft
	35%	from A47
	0%	from A1065
	35%	from A11
	30%	from A140 south
	0%	from A140 north
TOTAL		

Staff Vehicle Movements		
Assume	8%	via A148
	28%	via A47 east
	11%	from A146
	7%	from A47 west
	6%	from A1065
	16%	from A11
	13%	from A140 south
	12%	from A140 north
TOTAL		

167 Light Vehicles

94 Total HGVs

12hr Total Construction Traffic
Route Section 8

Key
10 Total Vehicles
(10) Heavy Goods Vehicles (HGVs)

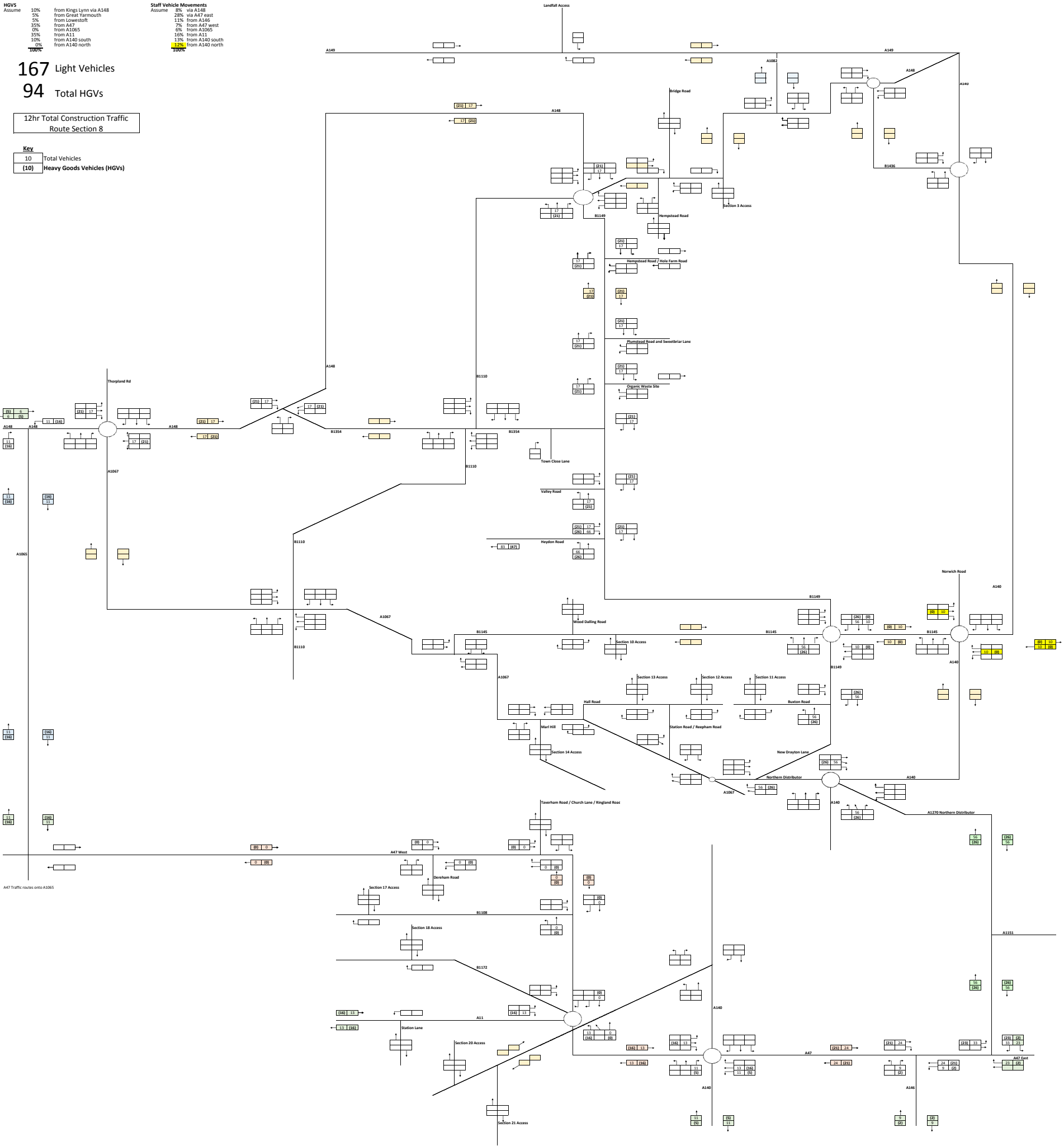

HGVs		Staff Vehicle Movements	
Assume	10%	Assume	8%
	from Kings Lynn via A148		via A148
	5%		28%
	from Great Yarmouth		via A47 east
	0%		11%
	from Lowestoft		from A146
	35%		7%
	from A47		from A47 west
	0%		6%
	from A1065		from A1065
	35%		10%
	from A11		from A11
	30%		13%
	from A140 south		from A140 south
	0%		12%
	from A140 north		from A140 north
	0%		10%

128 Light Vehicles
94 Total HGVs

12hr Total Construction Traffic
 Route Section 9

Key	
10	Total Vehicles
(10)	Heavy Goods Vehicles (HGVs)

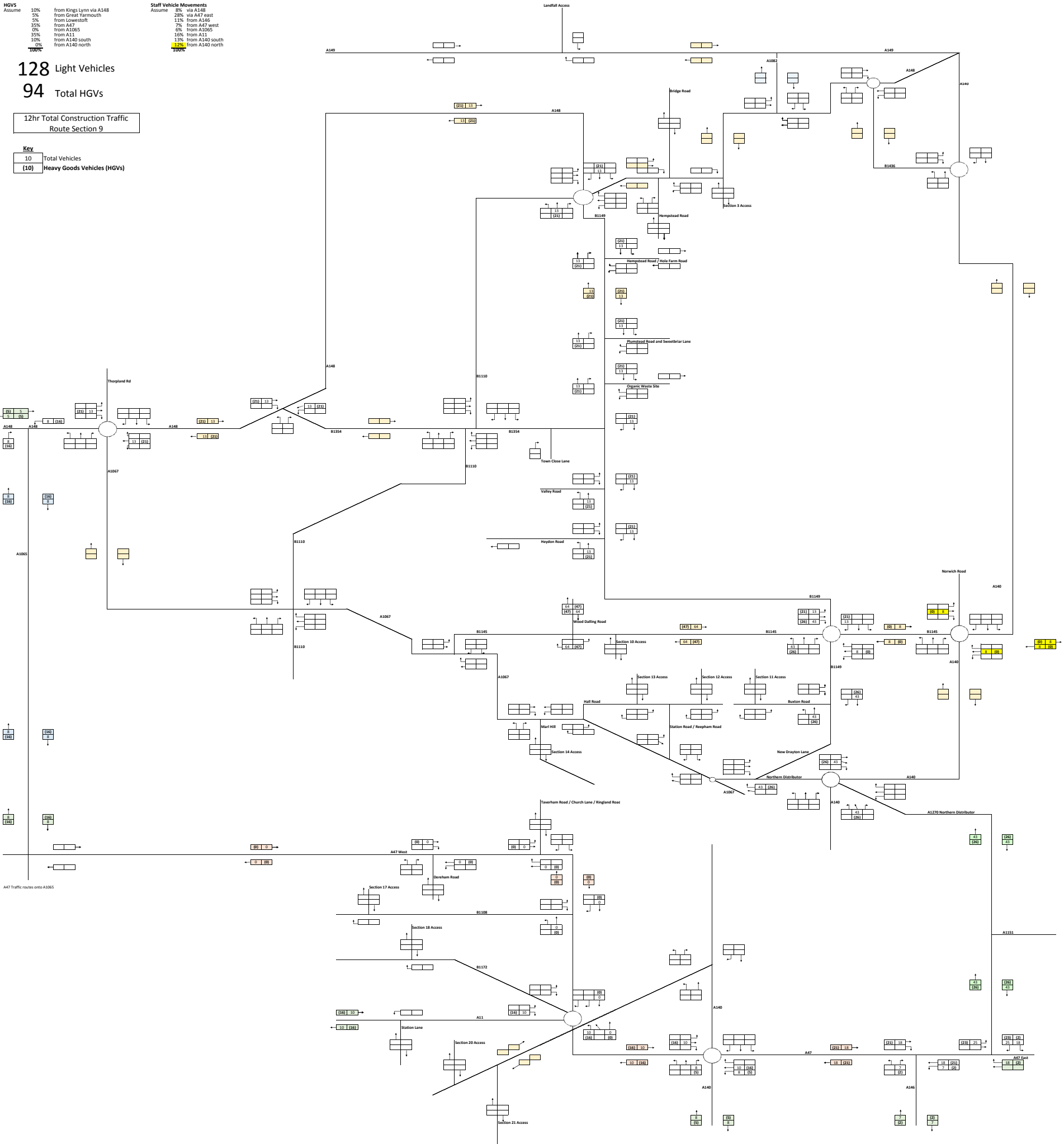

HGVs		
Assume	10%	from Kings Lynn via A148
	5%	from Great Yarmouth
	0%	from Lowestoft
	35%	from A47
	0%	from A1065
	35%	from A11
	30%	from A140 south
	0%	from A140 north
TOTAL		

Staff Vehicle Movements		
Assume	8%	via A148
	28%	via A47 east
	11%	from A146
	7%	from A47 west
	0%	from A1065
	10%	from A11
	13%	from A140 south
	12%	from A140 north
TOTAL		

116 Light Vehicles

96 Total HGVs

12hr Total Construction Traffic
Route Section 10

Key	
10	Total Vehicles
(10)	Heavy Goods Vehicles (HGVs)

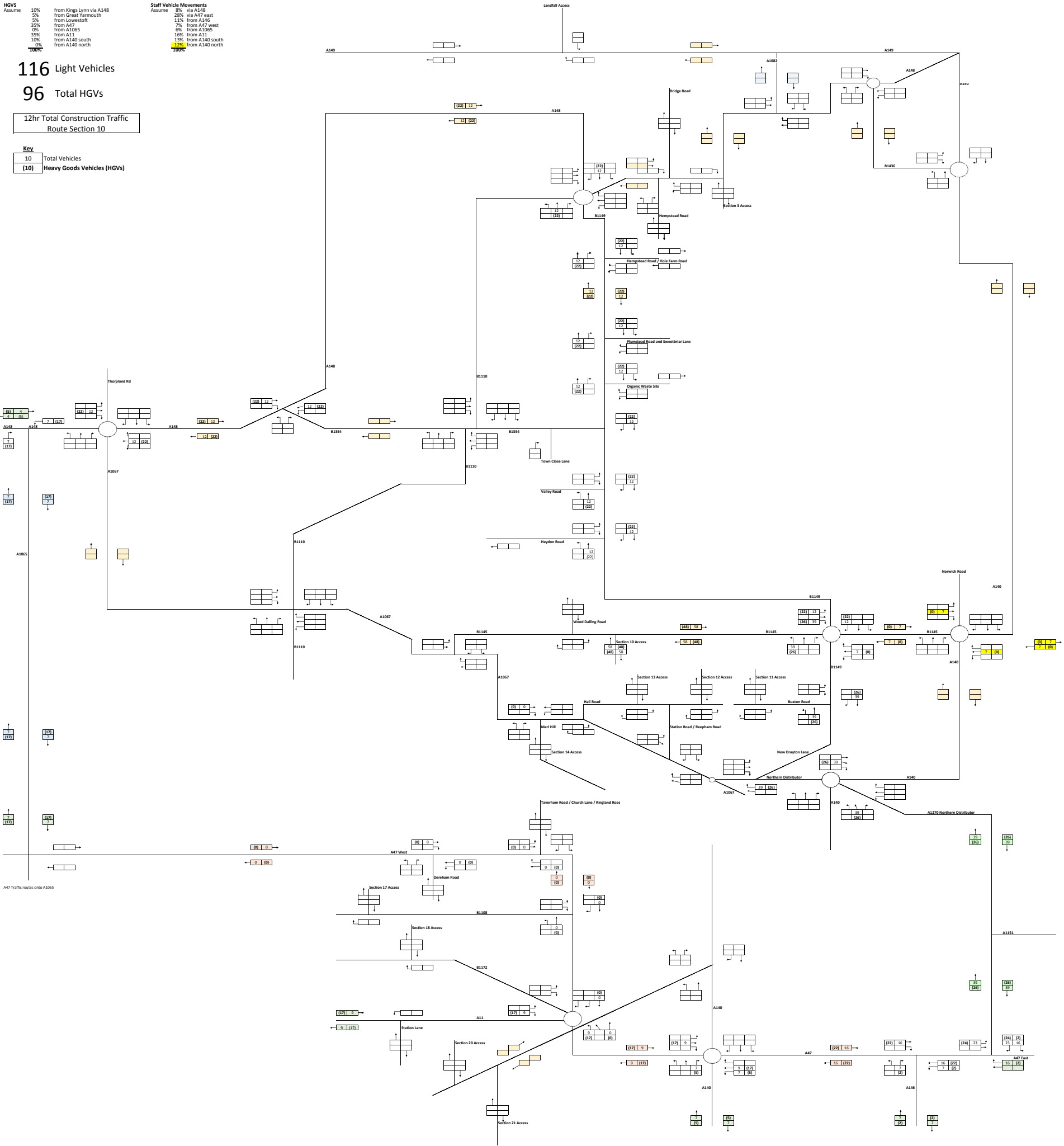

12hr Total Construction Traffic
Phase 2 Total

633 Light Vehicles

486 Total HGVs

Total Vehicles

Key
10 Total Vehicles
10 Heavy Goods Vehicles (HGVs)

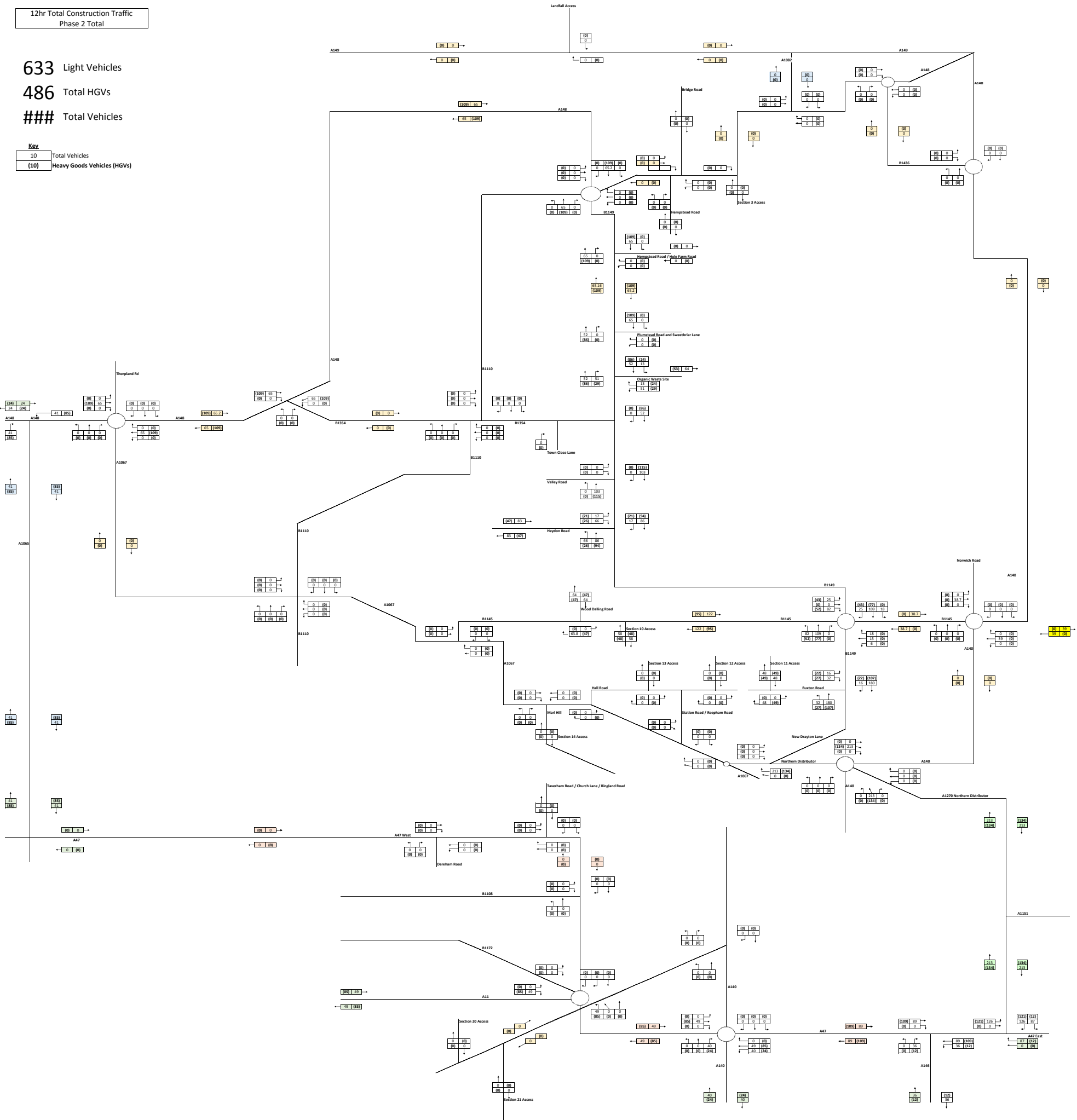

HGVs	Assume	10%	from Kings Lynn via A148
		5%	from Great Yarmouth
		5%	from Lowestoft
		35%	from A47
		0%	from A1065
		35%	from A11
		10%	from A140 south
		0%	from A140 north
		10%	from A140 north

Staff Vehicle Movements	Assume	8%	via A148
		28%	via A47 east
		11%	from A146
		7%	from A47 west
		6%	from A1065
		16%	from A11
		13%	from A140 south
		12%	from A140 north
		10%	from A140 north

69 Light Vehicles

94 Total HGVs

12hr Total Construction Traffic
Route Section 12

10	Total Vehicles
(10)	Heavy Goods Vehicles (HGVs)

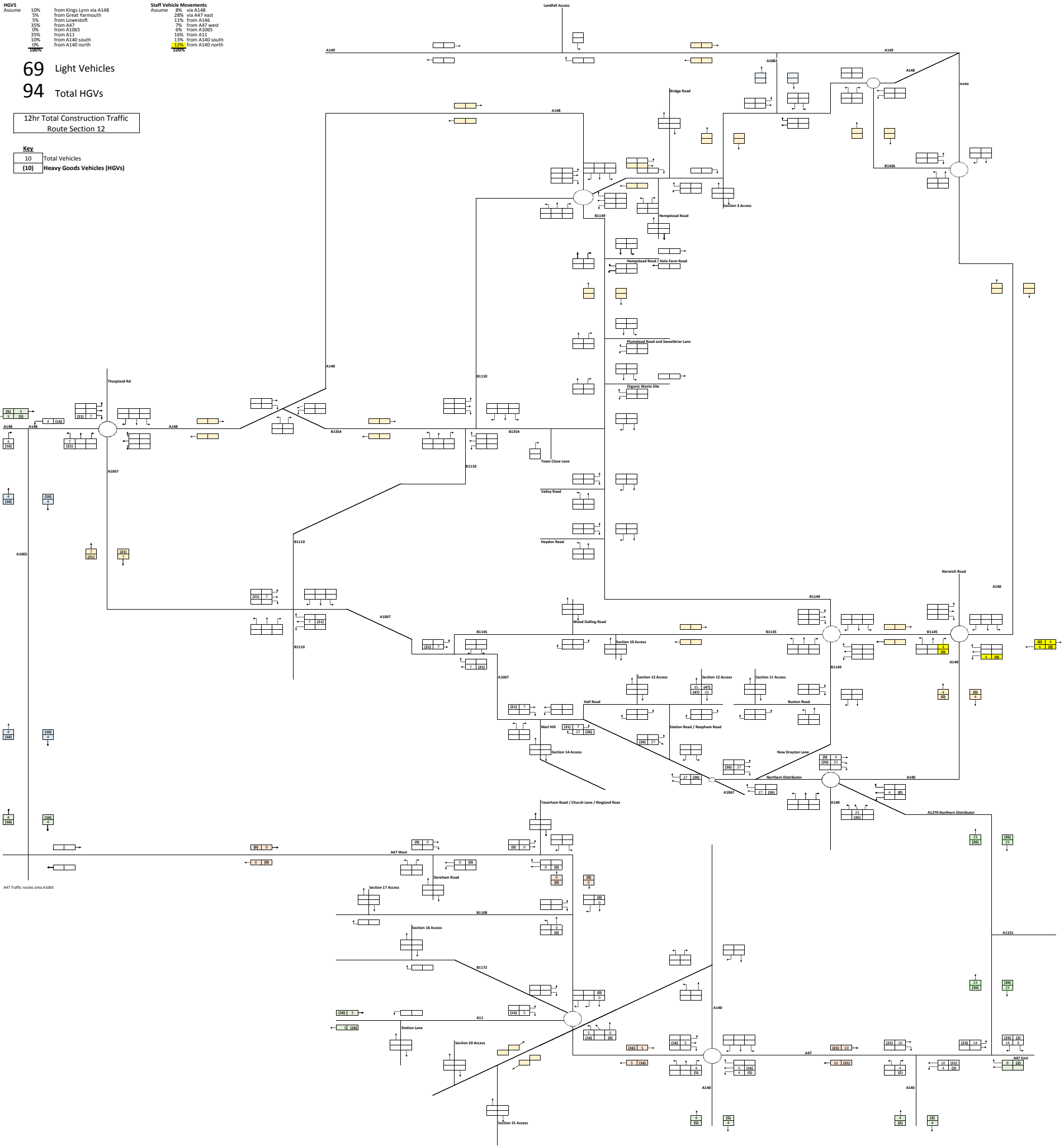

HGVs	10%	from Kings Lynn via A148	Staff Vehicle Movements	8%	via A148
Assume	5%	from Great Yarmouth	Assume	28%	via A47 east
	5%	from Lowestoft		11%	from A146
	35%	from A47		7%	from A47 west
	0%	from A1065		6%	from A1065
	35%	from A11		16%	from A11
	10%	from A140 south		13%	from A140 south
	0%	from A140 north		12%	from A140 north
	0%			12%	

96 Light Vehicles
96 Total HGVs

12hr Total Construction Traffic
 Route Section 13

Key
10 Total Vehicles
(10) Heavy Goods Vehicles (HGVs)

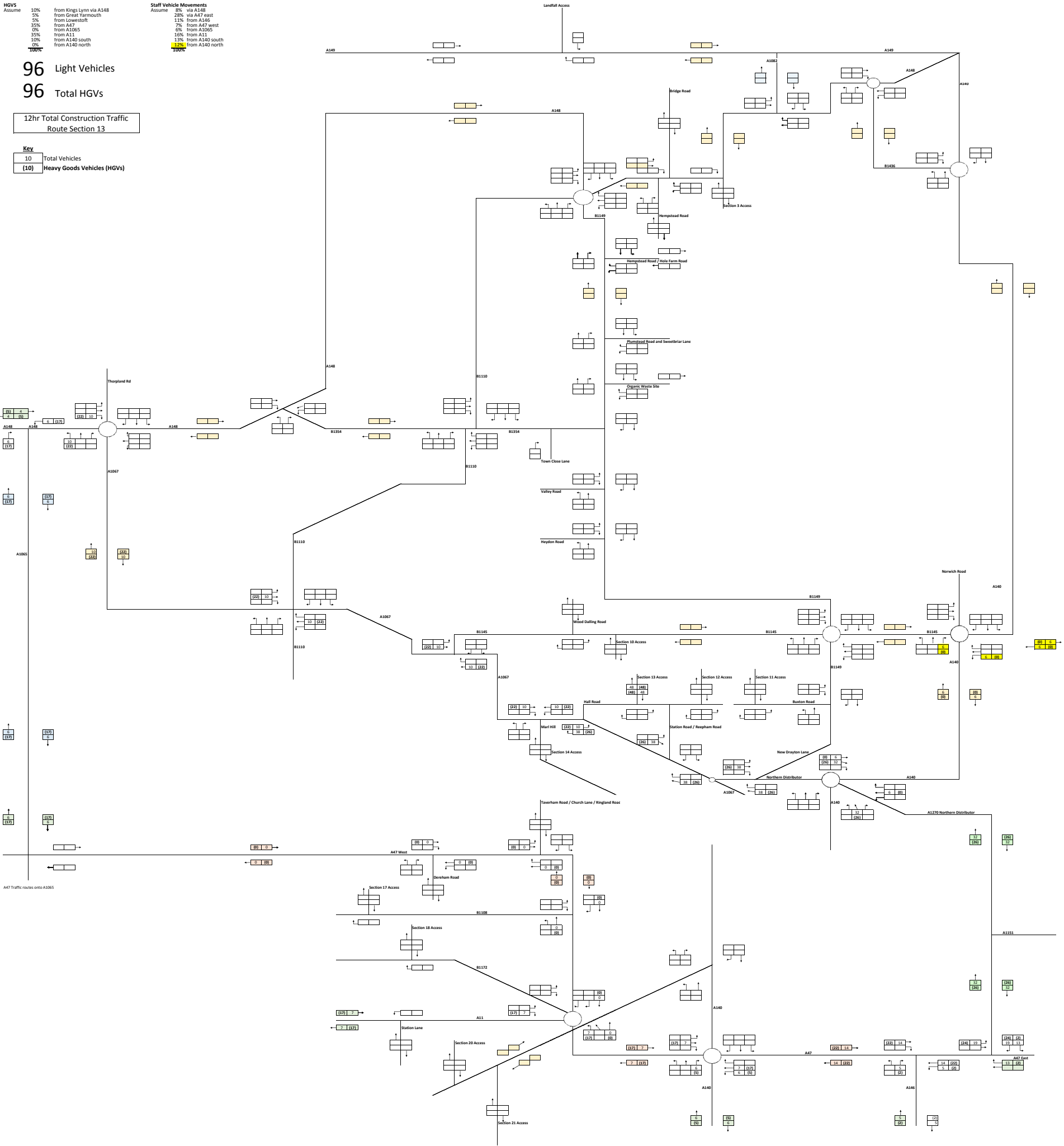

HGVs		Staff Vehicle Movements	
Assume	10%	Assume	28% via A148
	5%		28% via A47 east
	5%		11% from A146
	35%		7% from A47 west
	0%		0%
	0%		10%
	0%		13%
	0%		12%
	0%		12%

182 Light Vehicles
95 Total HGVs

12hr Total Construction Traffic
Route Section 14

Key
10 Total Vehicles
10 Heavy Goods Vehicles (HGVs)

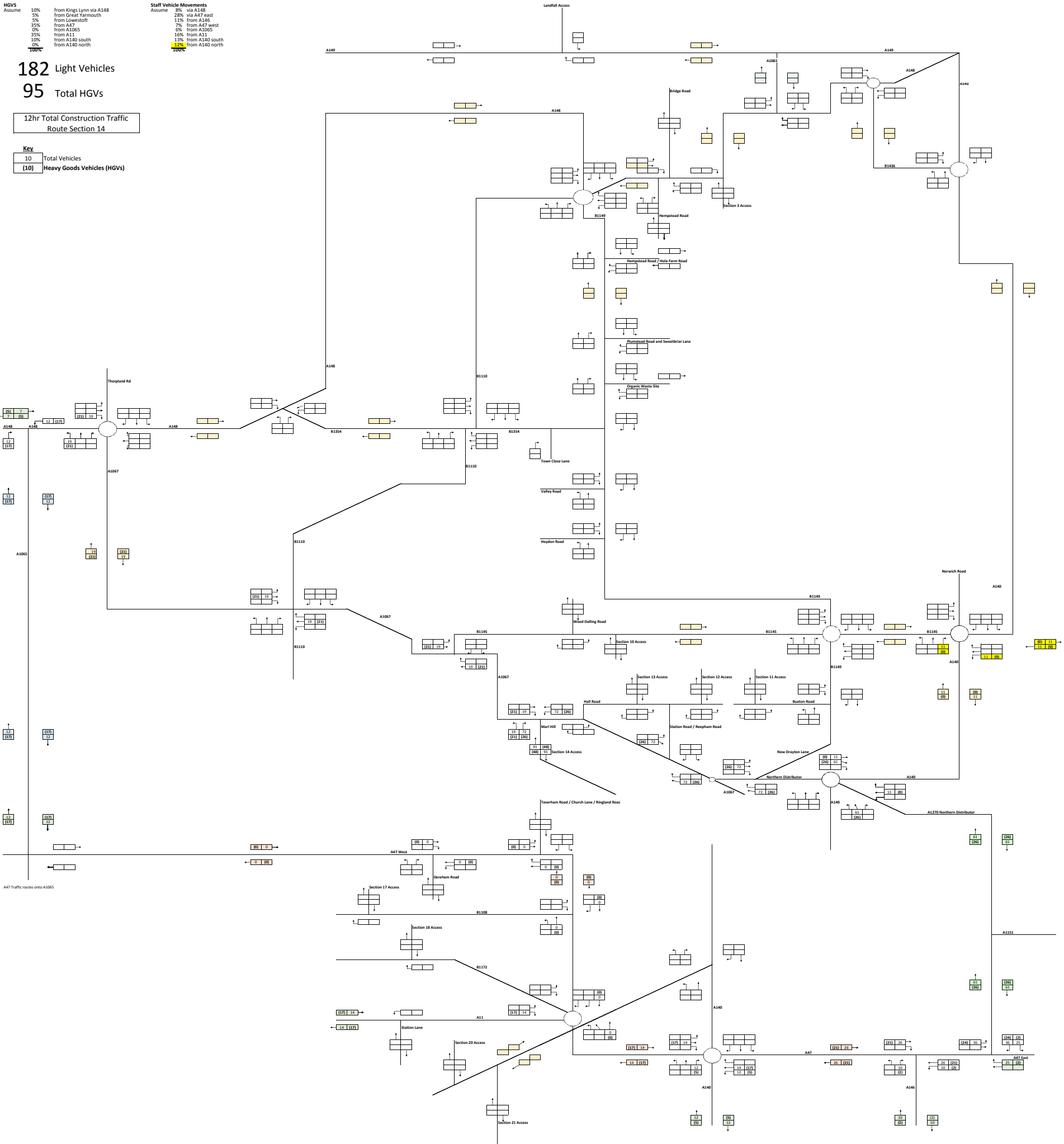

HGVS		Staff Vehicle Movements	
Assume	10%	Assume	8%
	5%		28%
	5%		11%
	35%		7%
	0%		6%
	35%		10%
	10%		3%
	0%		12%
	10%		10%

72 Light Vehicles
101 Total HGVs

12hr Total Construction Traffic
Route Section 15

Key	
10	Total Vehicles
(10)	Heavy Goods Vehicles (HGVs)

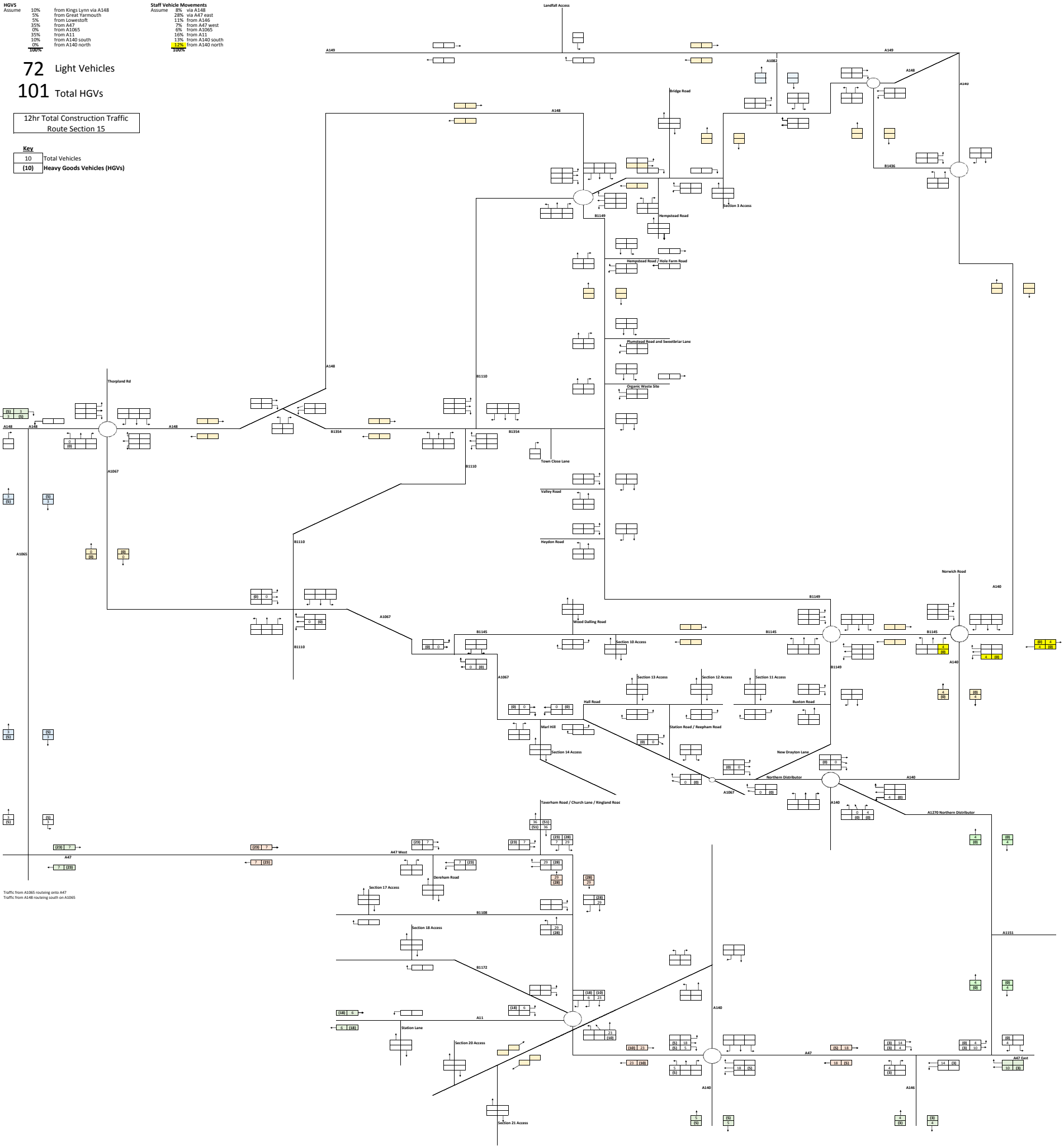

Traffic from A1065 routing onto A47
Traffic from A148 routing onto A1065

HGVs			
Assume	10%	from Kings Lynn via A148	
	5%	from Great Yarmouth	
	5%	from Lowestoft	
	35%	from A47	
	0%	from A1065	
	35%	from A11	
	10%	from A140 south	
	0%	from A140 north	
	10%	from A140 north	
	10%	from A140 north	

Staff Vehicle Movements		
Assume	8%	via A148
	28%	via A47 east
	11%	from A146
	7%	from A47 west
	6%	from A1065
	16%	from A11
	13%	from A140 south
	12%	from A140 north
	10%	from A140 north

128 Light Vehicles
97 Total HGVs

12hr Total Construction Traffic
 Route Section 16

Key	
10	Total Vehicles
10	Heavy Goods Vehicles (HGVs)

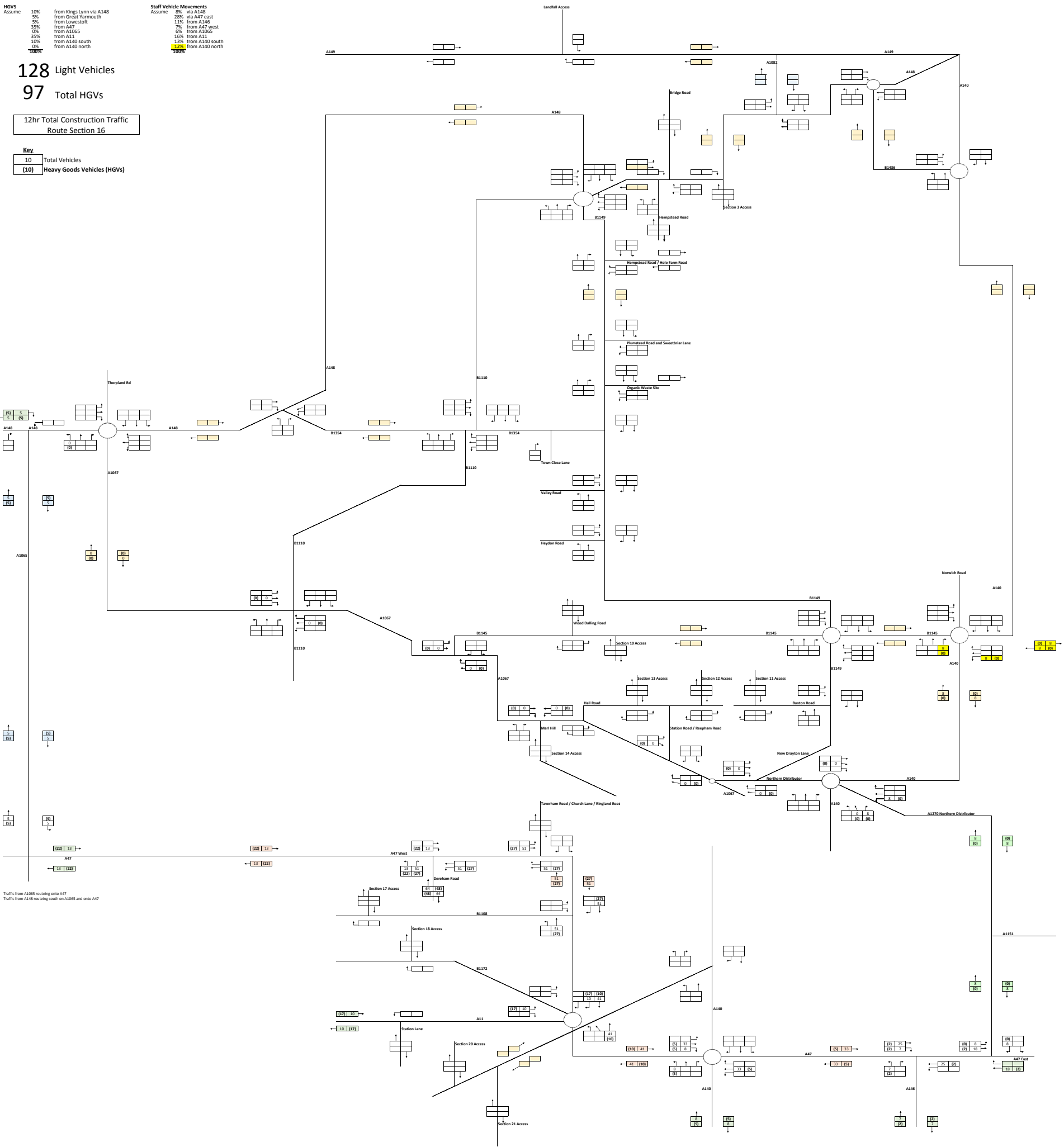

Traffic from A1065 routing onto A47
 Traffic from A148 routing south on A1065 and onto A47

12hr Total Construction Traffic
Phase 3 Total

546 Light Vehicles

483 Total HGVs

Total Vehicles

Key
10 Total Vehicles
10 Heavy Goods Vehicles (HGVs)

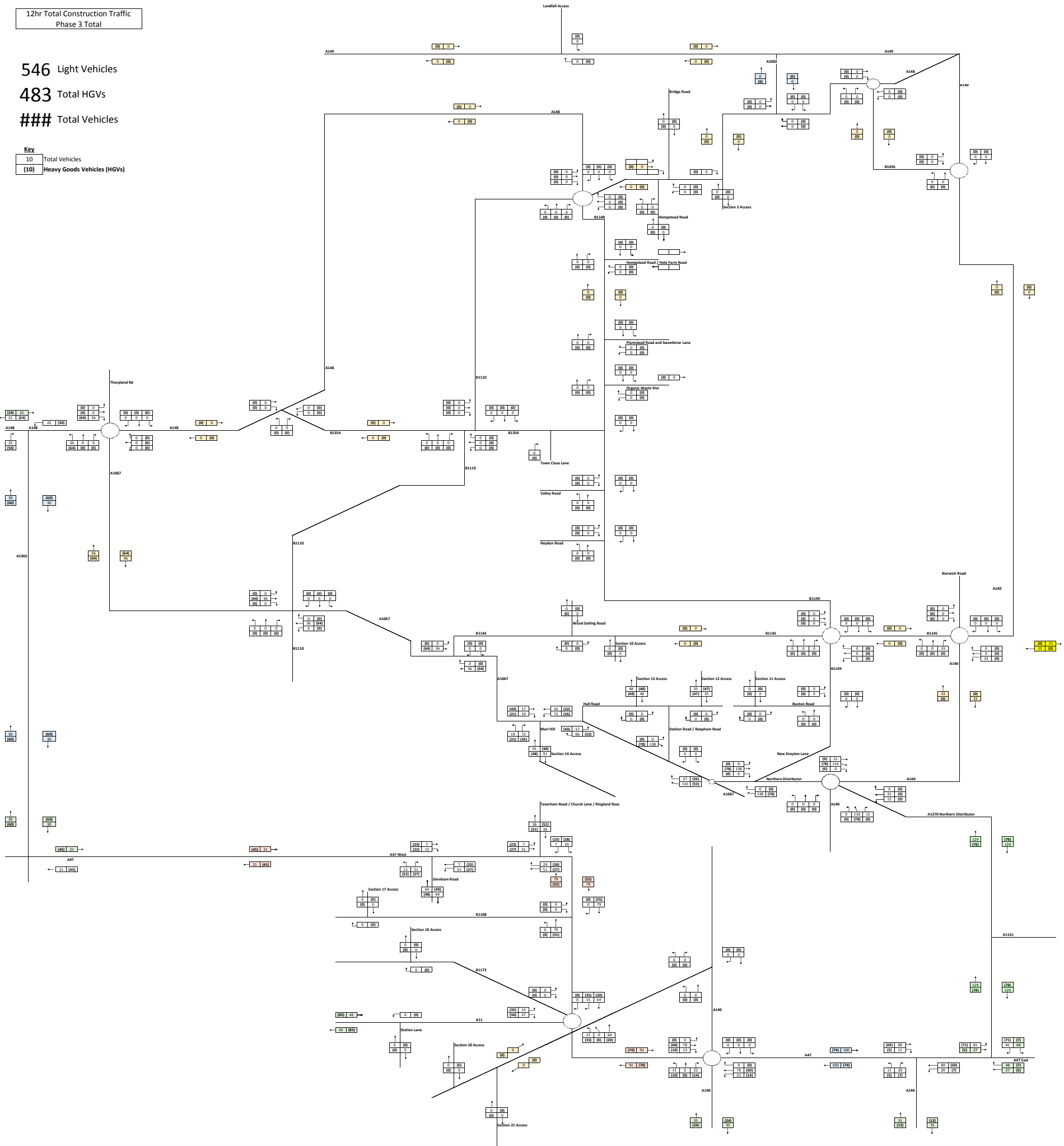

HGVs		Staff Vehicle Movements	
Assume		Assume	
10%	from Kings Lynn via A148	8%	via A148
5%	from Great Yarmouth	28%	via A47 east
5%	from Lowestoft	11%	from A146
35%	from A47	7%	from A47 west
0%	from A1065	6%	from A1065
35%	from A11	10%	from A11
10%	from A140 south	13%	from A140 south
0%	from A140 north	12%	from A140 north
0%		10%	

147 Light Vehicles
94 Total HGVs

12hr Total Construction Traffic
 Route Section 17

Key	
10	Total Vehicles
(10)	Heavy Goods Vehicles (HGVs)

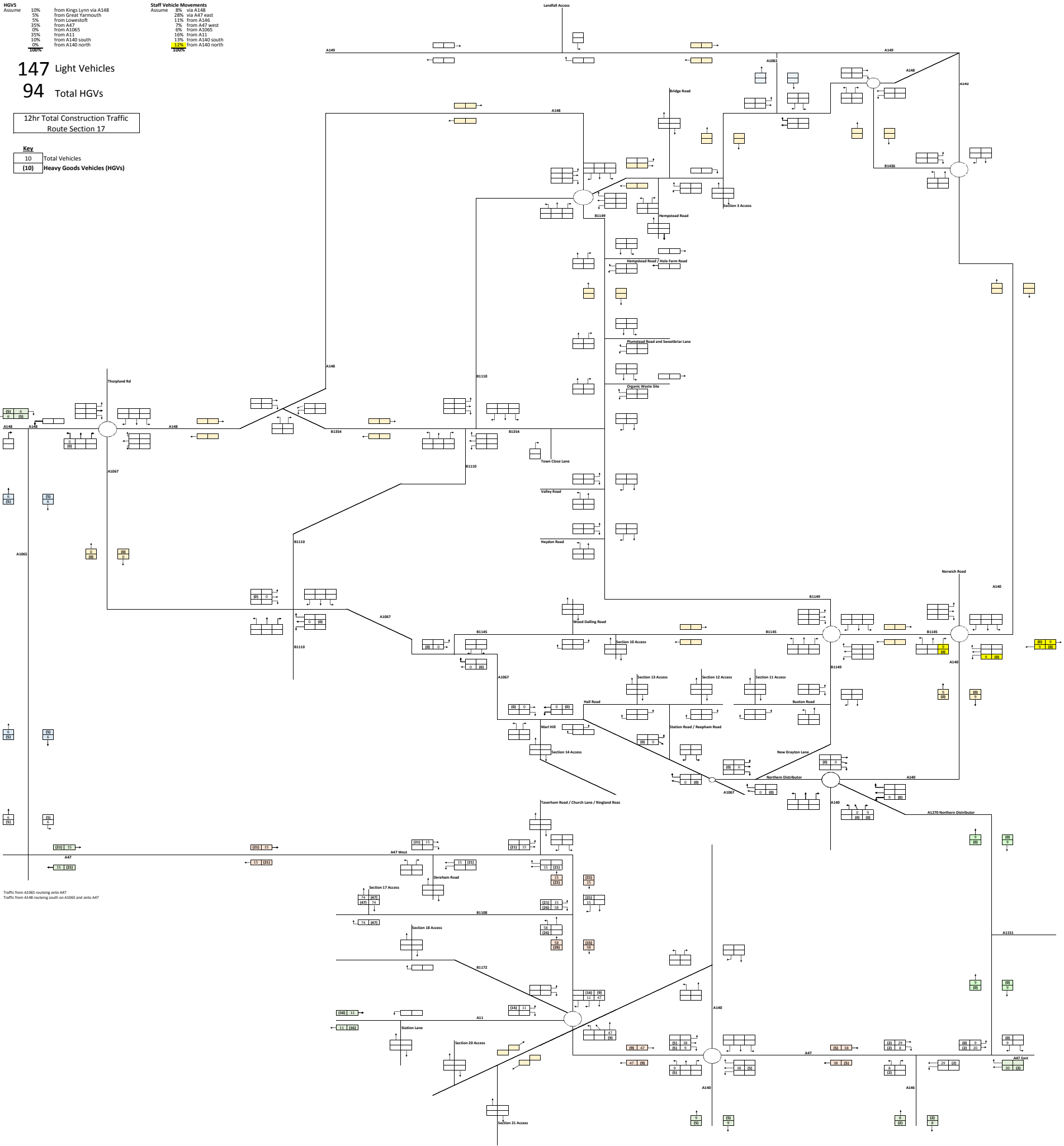

Traffic from A1065 routing onto A47
 Traffic from A148 routing south on A1065 and onto A47

HGVs	Assume	10%	from Kings Lynn via A148
	Assume	5%	from Great Yarmouth
	Assume	5%	from Lowestoft
	Assume	35%	from A47
	Assume	0%	from A1065
	Assume	35%	from A11
	Assume	10%	from A140 south
	Assume	0%	from A140 north
	Assume	10%	from A140 north

Staff Vehicle Movements	Assume	8%	via A148
	Assume	28%	via A47 east
	Assume	11%	from A146
	Assume	7%	from A47 west
	Assume	6%	from A1065
	Assume	16%	from A11
	Assume	13%	from A140 south
	Assume	12%	from A140 north
	Assume	0%	from A140 north

221 Light Vehicles
96 Total HGVs

12hr Total Construction Traffic
Route Section 18

Key	
10	Total Vehicles
(10)	Heavy Goods Vehicles (HGVs)

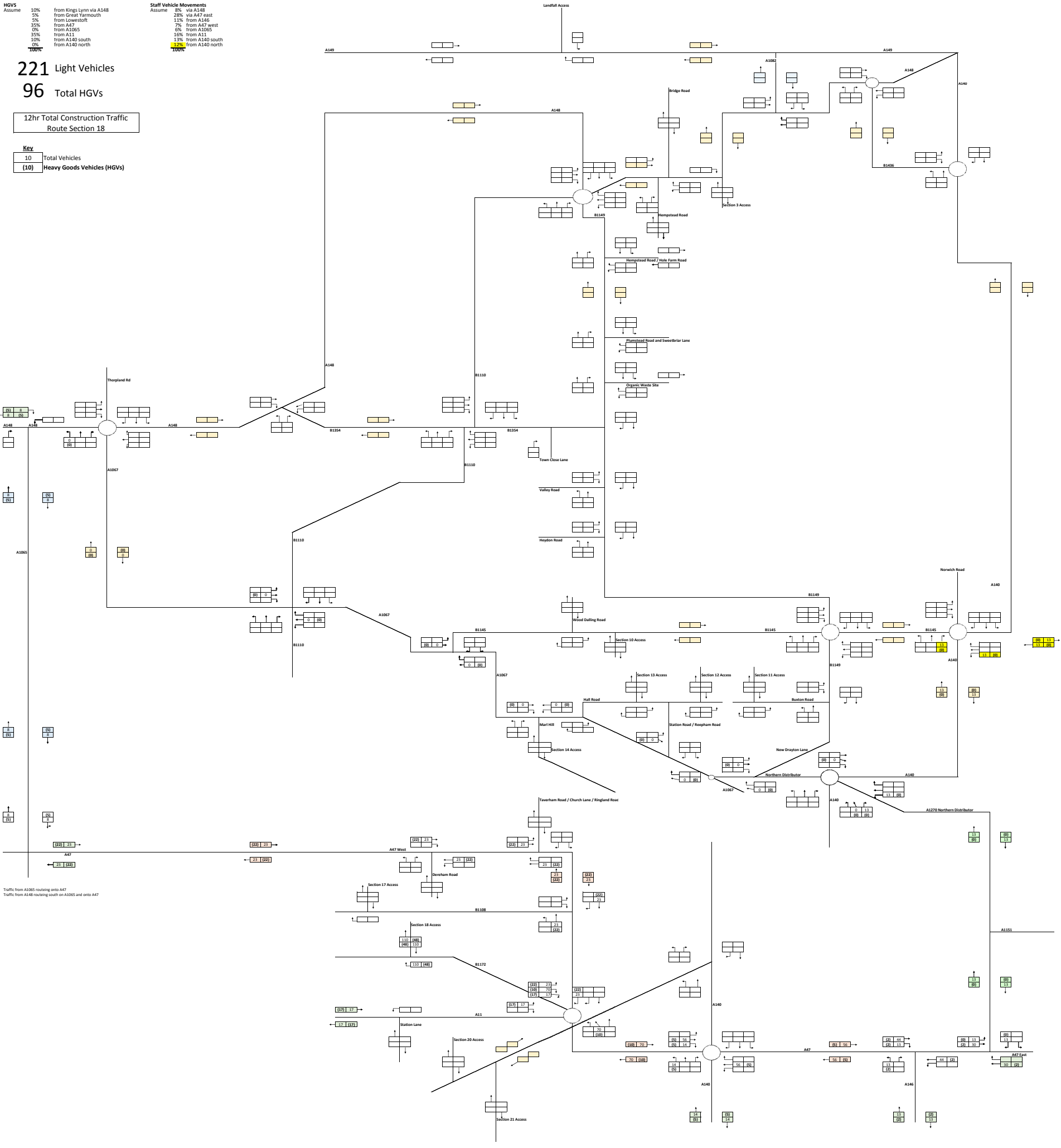

Traffic from A1065 routing onto A47
Traffic from A148 routing onto A1065 and onto A47

HGVs	10%	from Kings Lynn via A148	Staff Vehicle Movements	8%	via A148
Assume	5%	from Great Yarmouth	Assume	28%	via A47 east
	5%	from Lowestoft		11%	from A146
	35%	from A47		7%	from A47 west
	0%	from A1065		6%	from A1065
	35%	from A11		16%	from A11
	10%	from A140 south		13%	from A140 south
	0%	from A140 north		12%	from A140 north
	0%			12%	

96 Light Vehicles

95 Total HGVs

12hr Total Construction Traffic
Route Section 19

Key
10 Total Vehicles
(10) Heavy Goods Vehicles (HGVs)

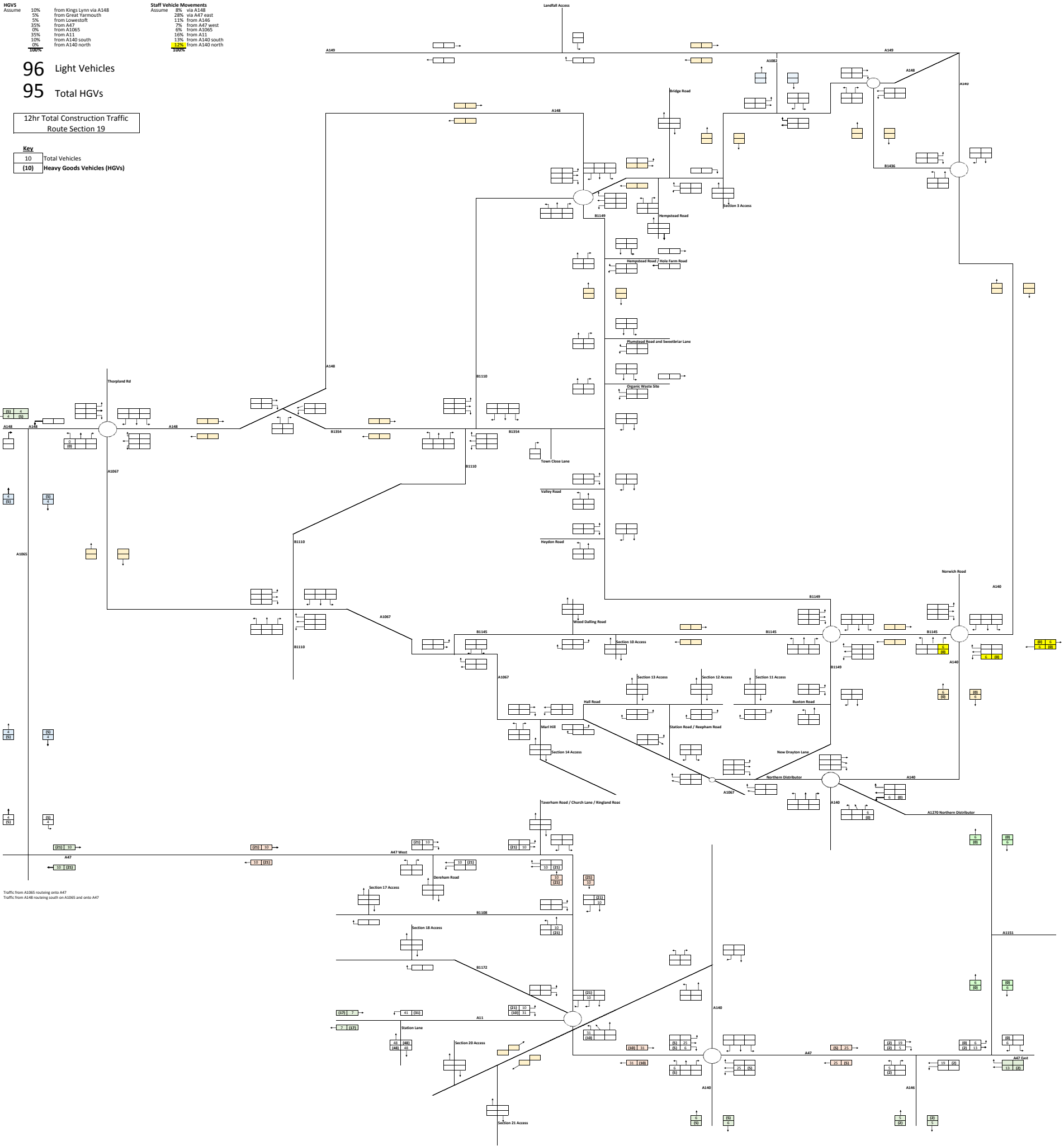

Traffic from A1065 reaching onto A47
Traffic from A148 reaching south on A1065 and onto A47

HGVs		Staff Vehicle Movements	
Assume		Assume	
10%	from Kings Lynn via A148	8%	via A148
5%	from Great Yarmouth	28%	via A47 east
5%	from Lowestoft	11%	from A146
35%	from A47	7%	from A47 west
0%	from A1065	6%	from A1065
35%	from A11	16%	from A11
10%	from A140 south	13%	from A140 south
0%	from A140 north	12%	from A140 north
0%		12%	

108 Light Vehicles
95 Total HGVs

12hr Total Construction Traffic
 Route Section 20

Key	
10	Total Vehicles
(10)	Heavy Goods Vehicles (HGVs)

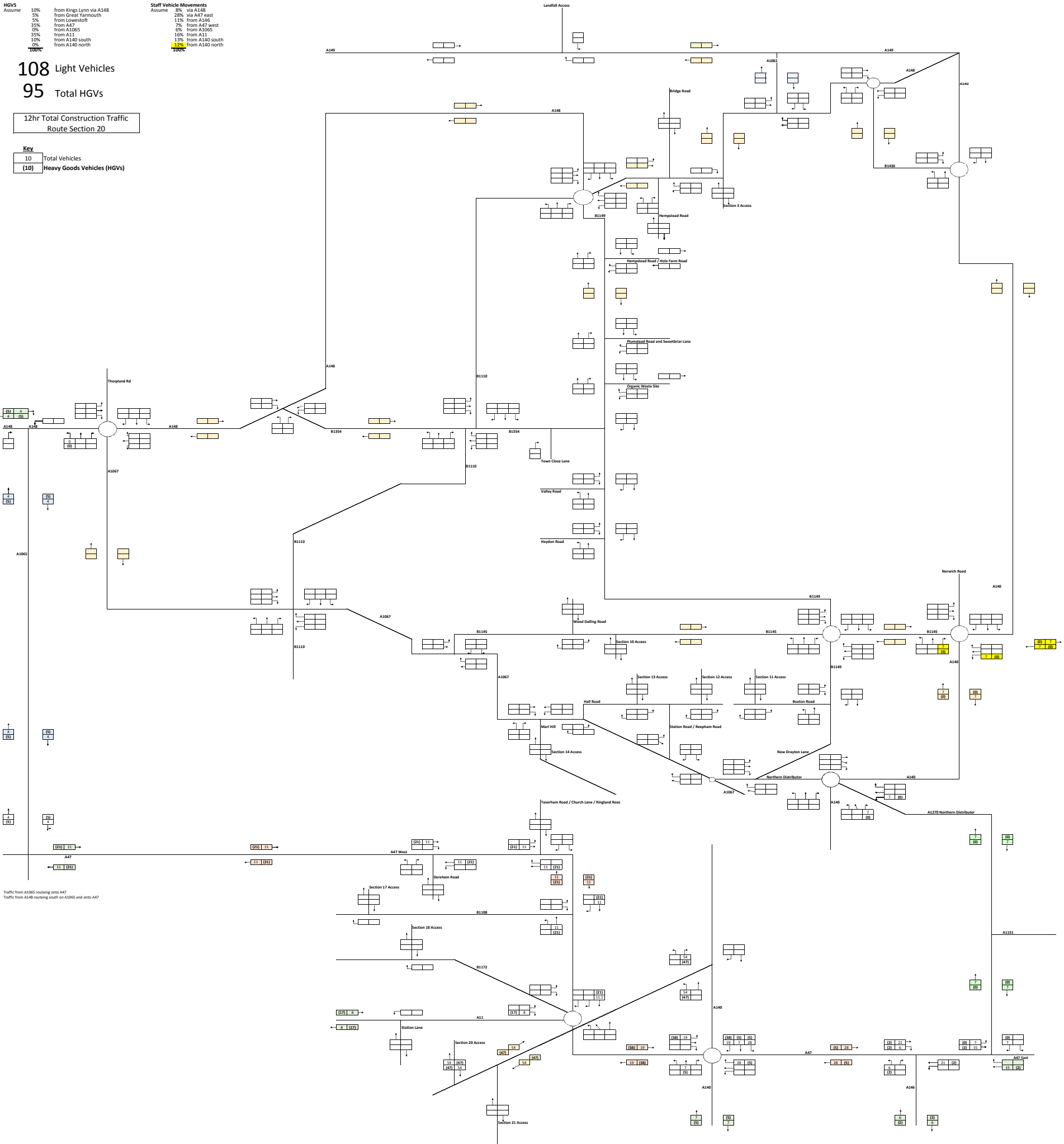

Traffic from A1065 reaching onto A47
 Traffic from A148 reaching south on A1065 and onto A47

HGVs		Staff Vehicle Movements	
Assume		Assume	
10%	from Kings Lynn via A148	8%	via A148
5%	from Great Yarmouth	28%	via A47 east
5%	from Lowestoft	11%	from A146
35%	from A47	7%	from A47 west
0%	from A1065	0%	from A1065
35%	from A11	10%	from A11
10%	from A140 south	13%	from A140 south
0%	from A140 north	12%	from A140 north
0%		10%	

128 Light Vehicles

140 Total HGVs

12hr Total Construction Traffic
Route Section 21

Key	
10	Total Vehicles
(10)	Heavy Goods Vehicles (HGVs)

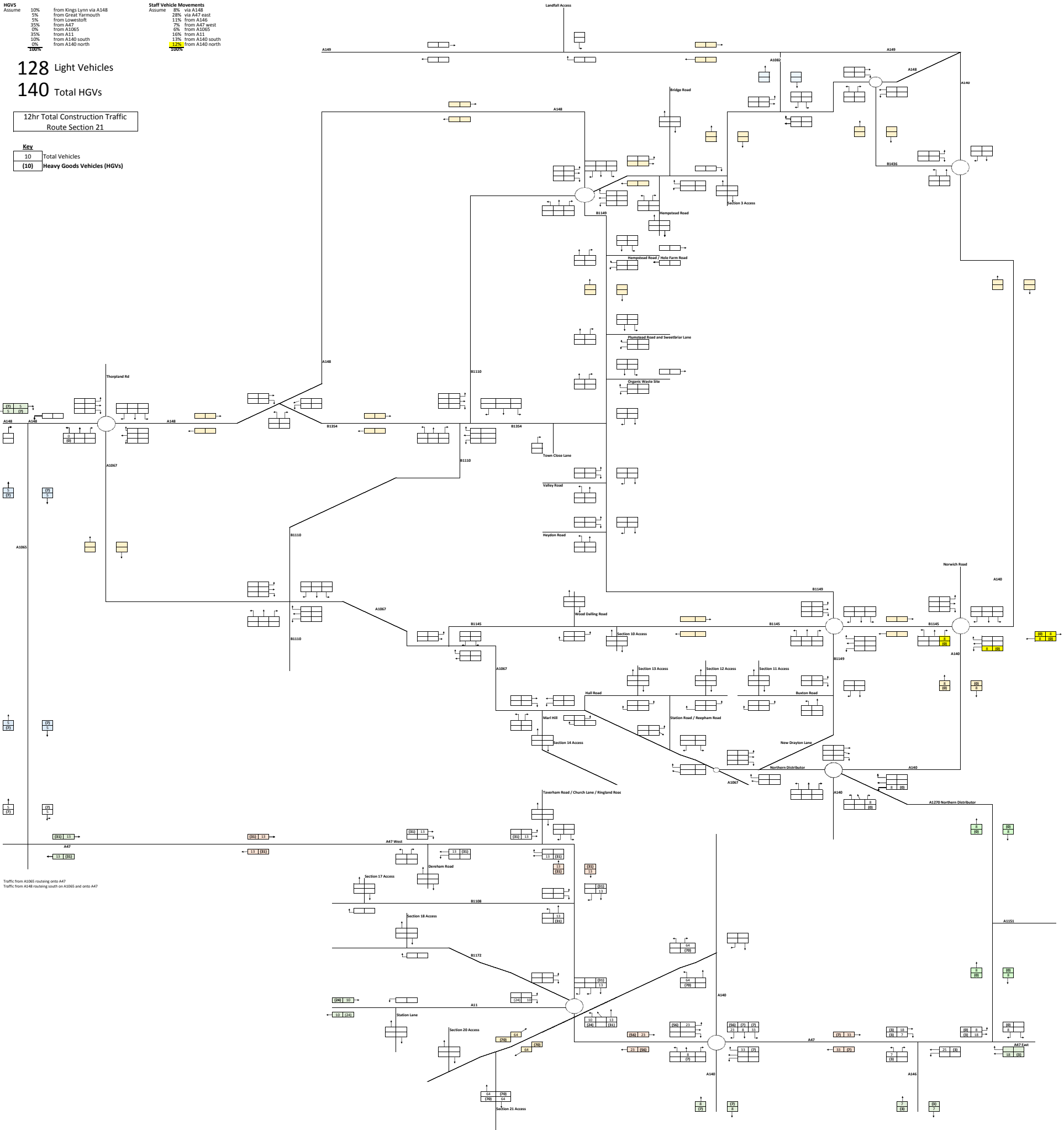

Traffic from A1065 reaching onto A47
Traffic from A148 reaching onto A1065 and onto A47

12hr Total Construction Traffic
Phase 4 Total

699 Light Vehicles

520 Total HGVs

Total Vehicles

Key
10 Total Vehicles
(10) Heavy Goods Vehicles (HGVs)

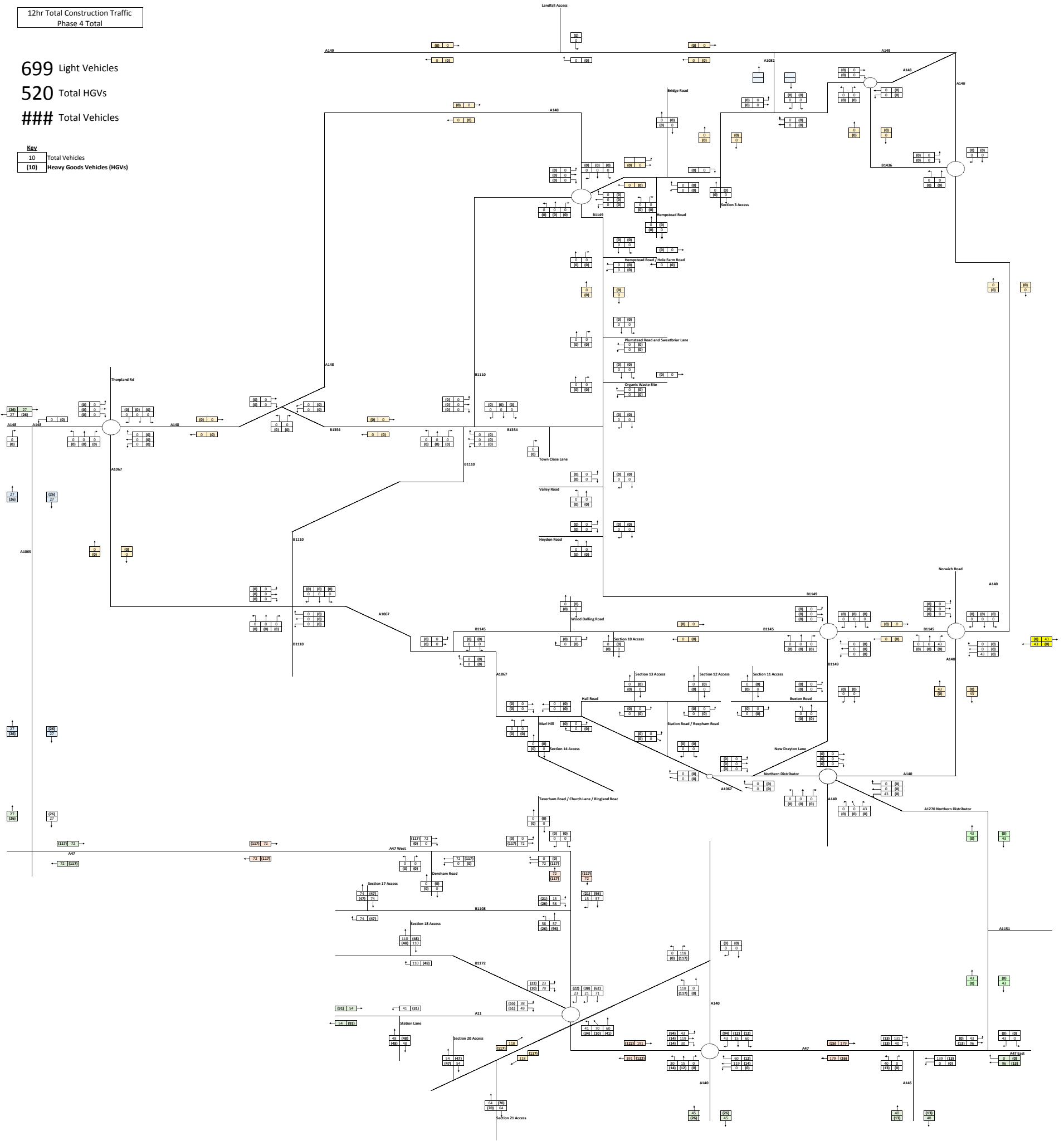

HGVs		Staff Vehicle Movements	
Assume	10%	Assume	8%
	from Kings Lynn via A148		via A148
	5%		28%
	from Great Yarmouth		via A47 east
	5%		11%
	from Lowestoft		from A146
	35%		7%
	from A47		from A11
	0%		10%
	from A1065		13%
	35%		from A140 south
	0%		12%
	from A11		from A140 north
	30%		0%
	from A140 south		
	0%		
	from A140 north		
	0%		
	10%		

10 Light Vehicles
5 Total HGVs

12hr Total Construction Traffic
 Landfall

Key
 10 Total Vehicles
 (10) Heavy Goods Vehicles (HGVs)

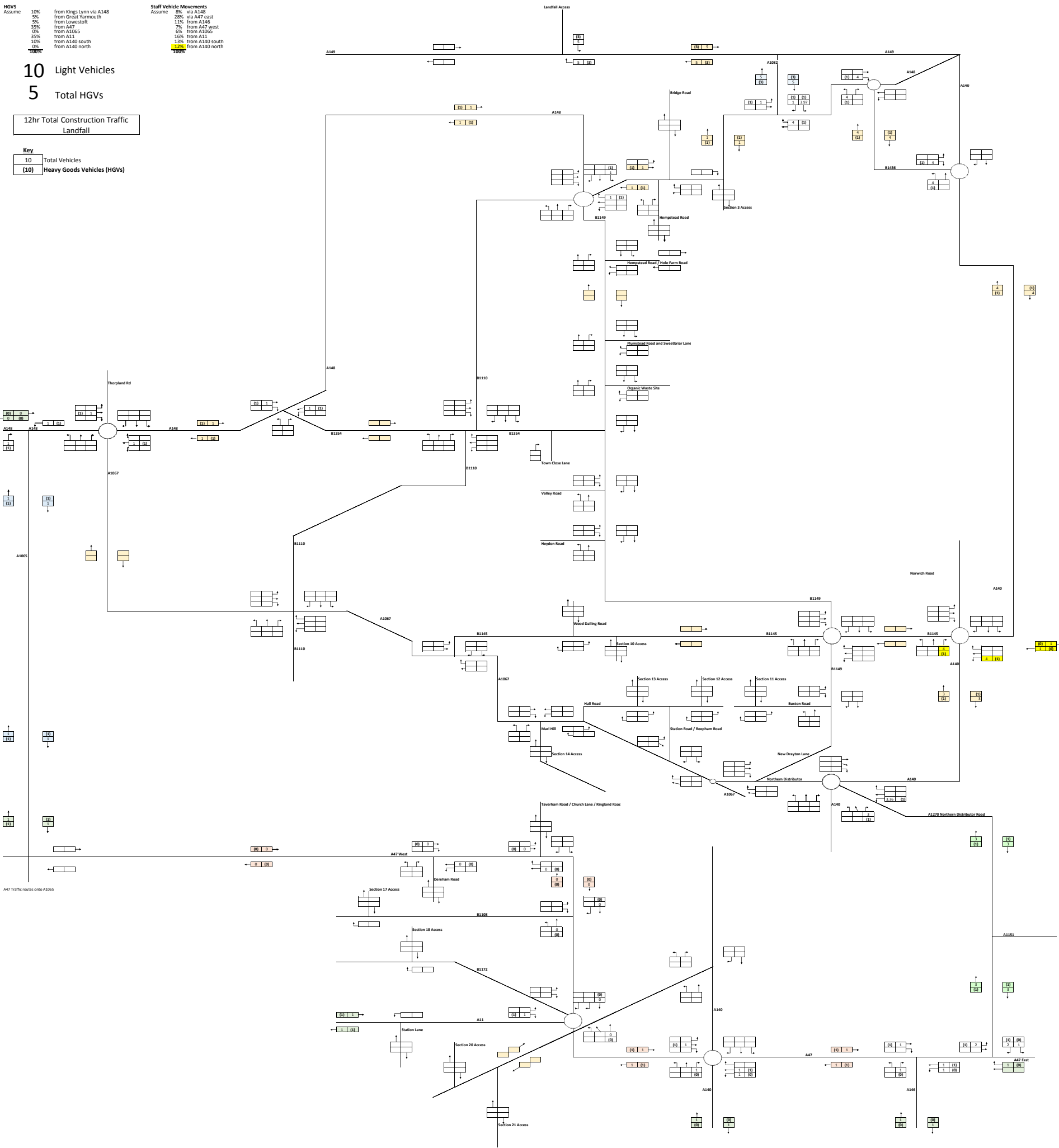

HGVs			Staff Vehicle Movements		
Assume	10%	from Kings Lynn via A148	Assume	8%	via A148
	5%	from Great Yarmouth		28%	via A47 east
	5%	from Lowestoft		11%	from A146
	35%	from A47		7%	from A47 west
	0%	from A1065		0%	from A1065
	35%	from A11		10%	from A11
	30%	from A140 south		3%	from A140 south
	0%	from A140 north		12%	from A140 north
	0%			12%	

34 Light Vehicles

12 Total HGVs

12hr Total Construction Traffic
Booster Station

Key
10 Total Vehicles
(10) Heavy Goods Vehicles (HGVs)

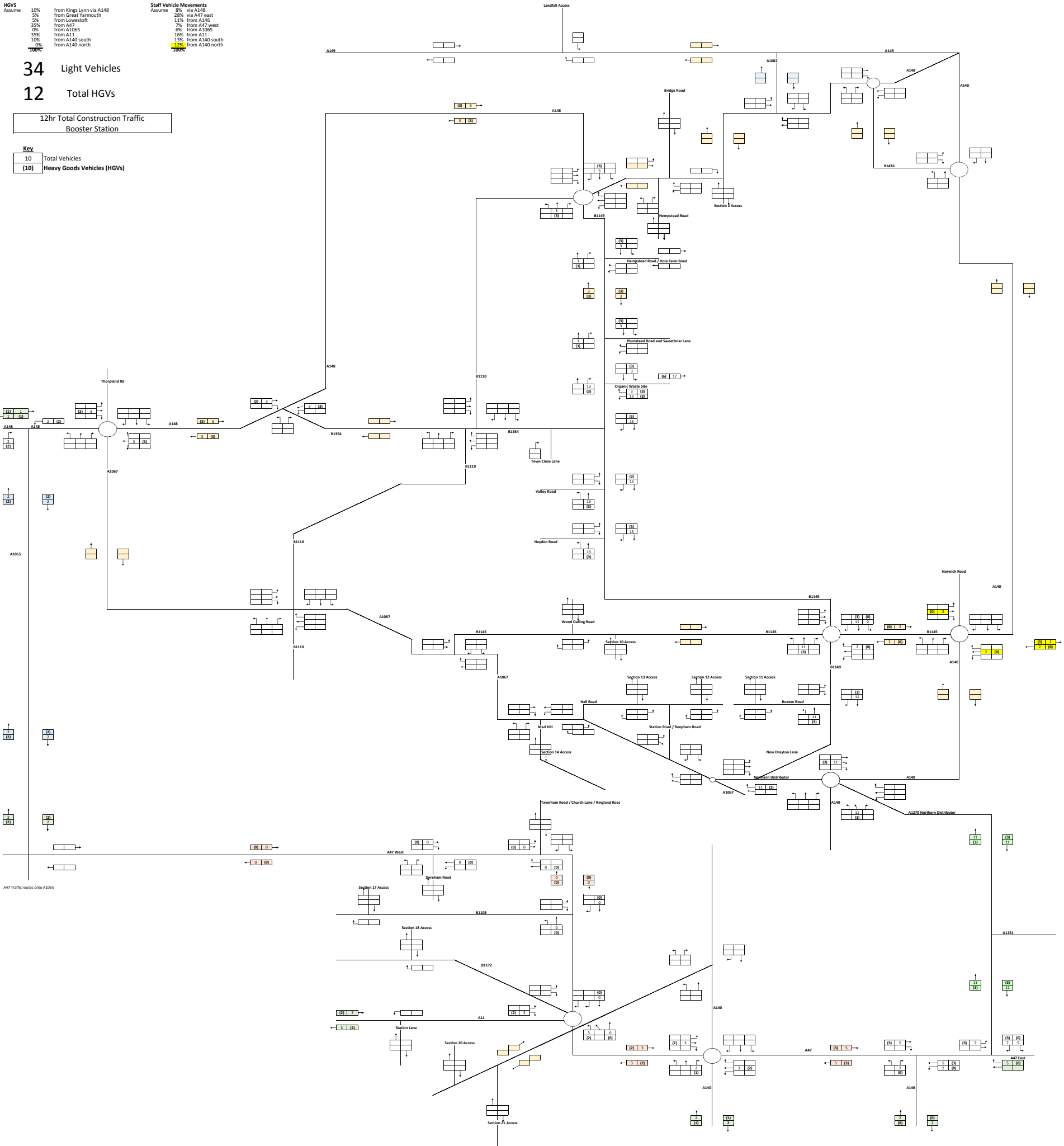

HGVS		Staff Vehicle Movements	
Assume	10%	Assume	8%
	5%		28%
	5%		11%
	35%		7%
	0%		6%
	35%		16%
	10%		3%
	0%		12%
	10%		12%

82 Light Vehicles
29 Total HGVs

12hr Total Construction Traffic
HVAC Substation

Key	
10	Total Vehicles
(10)	Heavy Goods Vehicles (HGVs)

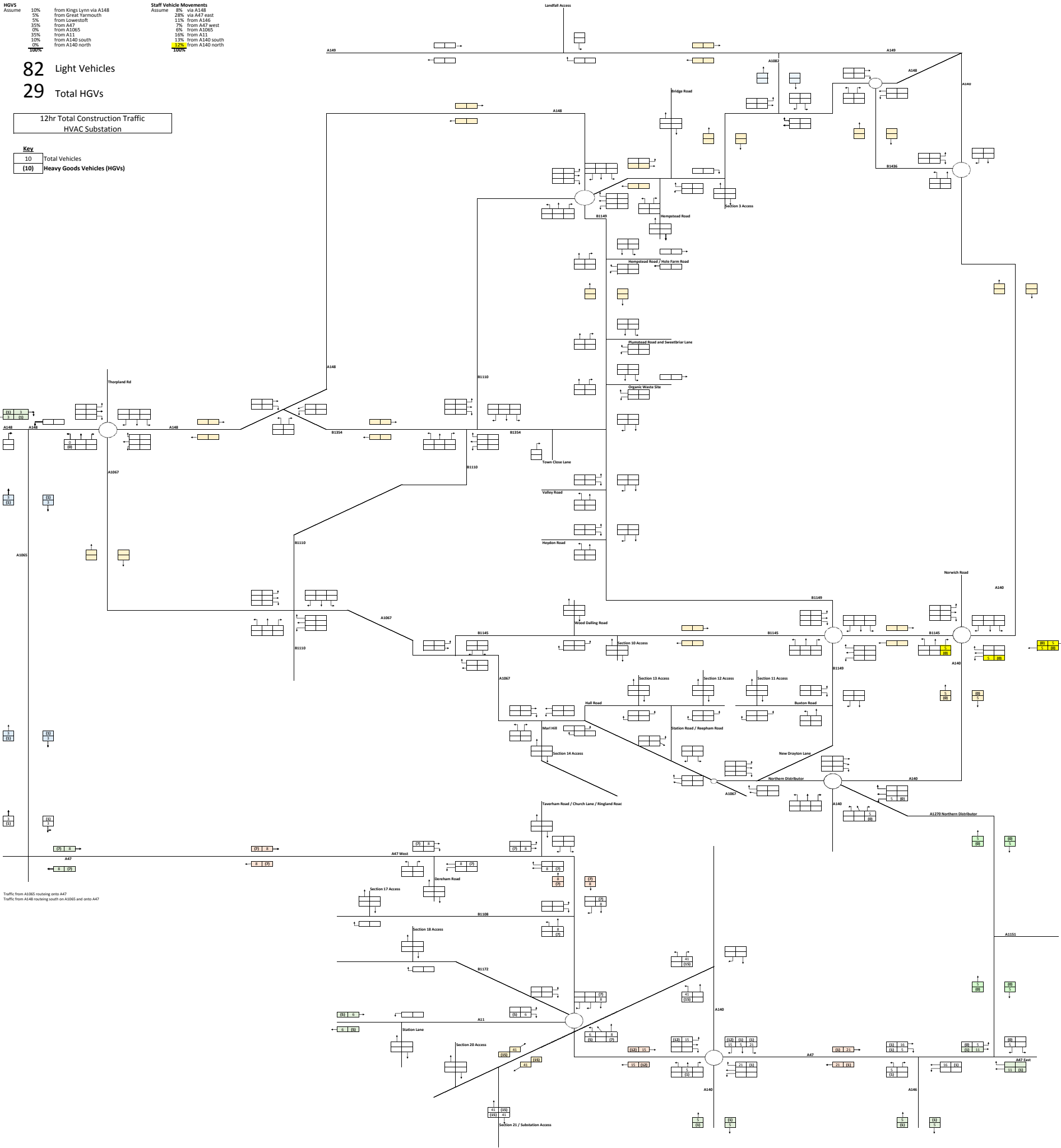

Traffic from A1065 routing onto A47
Traffic from A148 routing south on A1065 and onto A47

12hr Total Construction Traffic
Maximum Construction Traffic

2,469 Light Vehicles
2,019 Total HGVs
4,488 Total Vehicles

Key
10 Total Vehicles
(10) Heavy Goods Vehicles (HGVs)

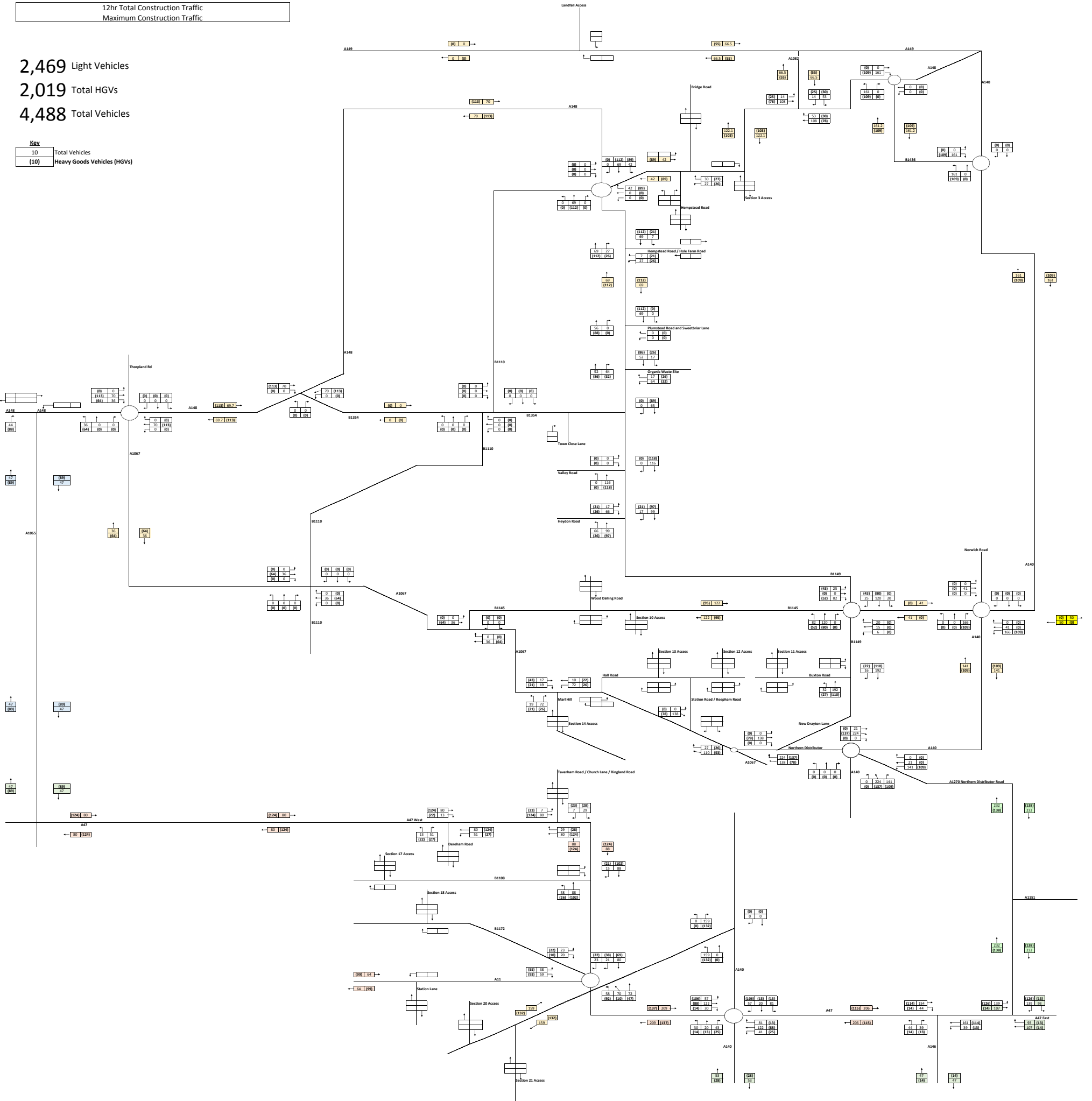

12hr Total Construction Traffic
Total Construction Traffic (excluding Section 7)

2,469 Light Vehicles
2,019 Total HGVs
4,488 Total Vehicles

Key	
10	Total Vehicles
(10)	Heavy Goods Vehicles (HGVs)

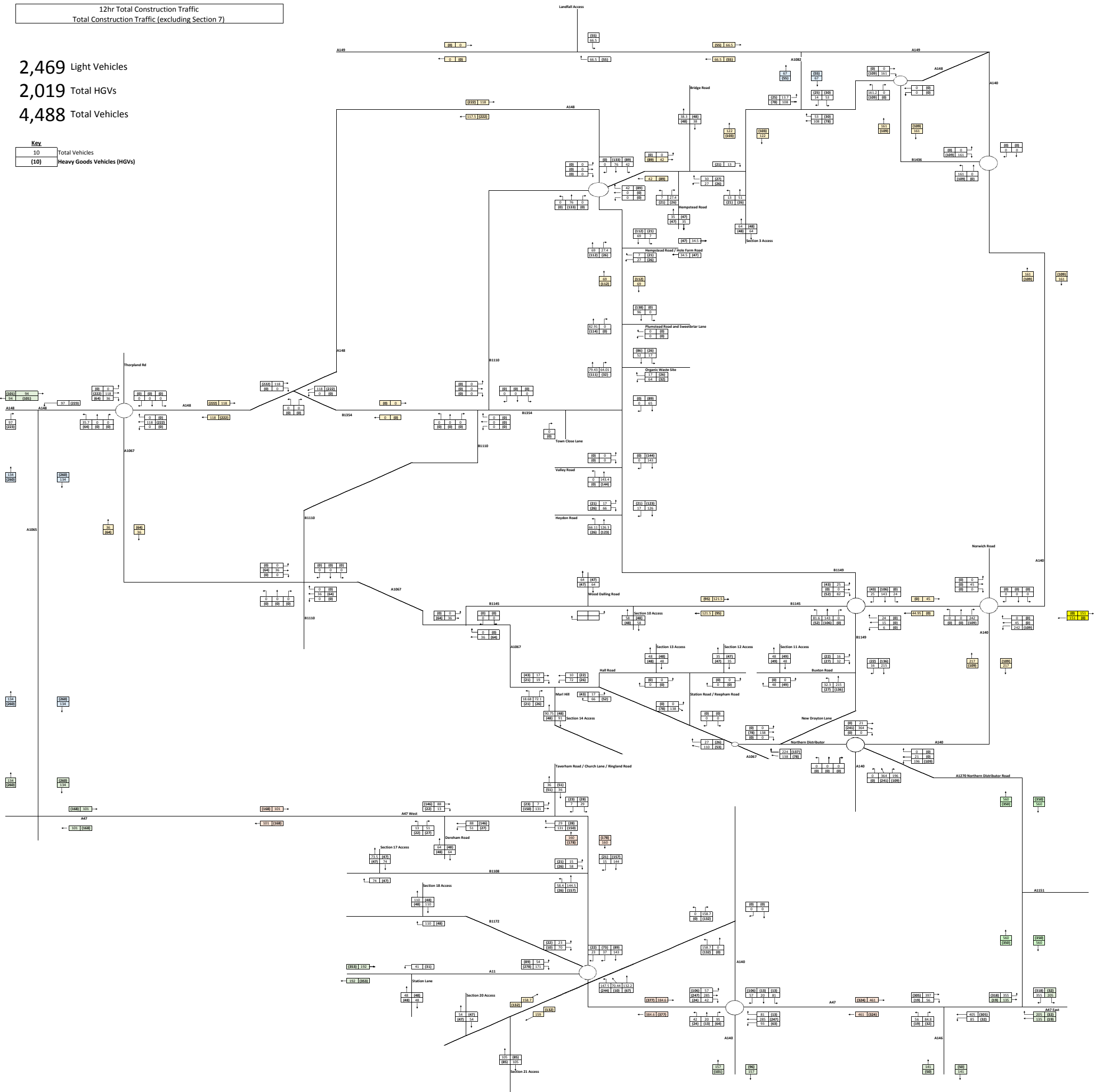

Traffic Flow Diagrams

12hr Total Construction Traffic
Sensitivity Scenario

2017 Observed Traffic Flows

07:00-19:00

Key
10 Total Vehicles
(10) Heavy Goods Vehicles (HGVs)

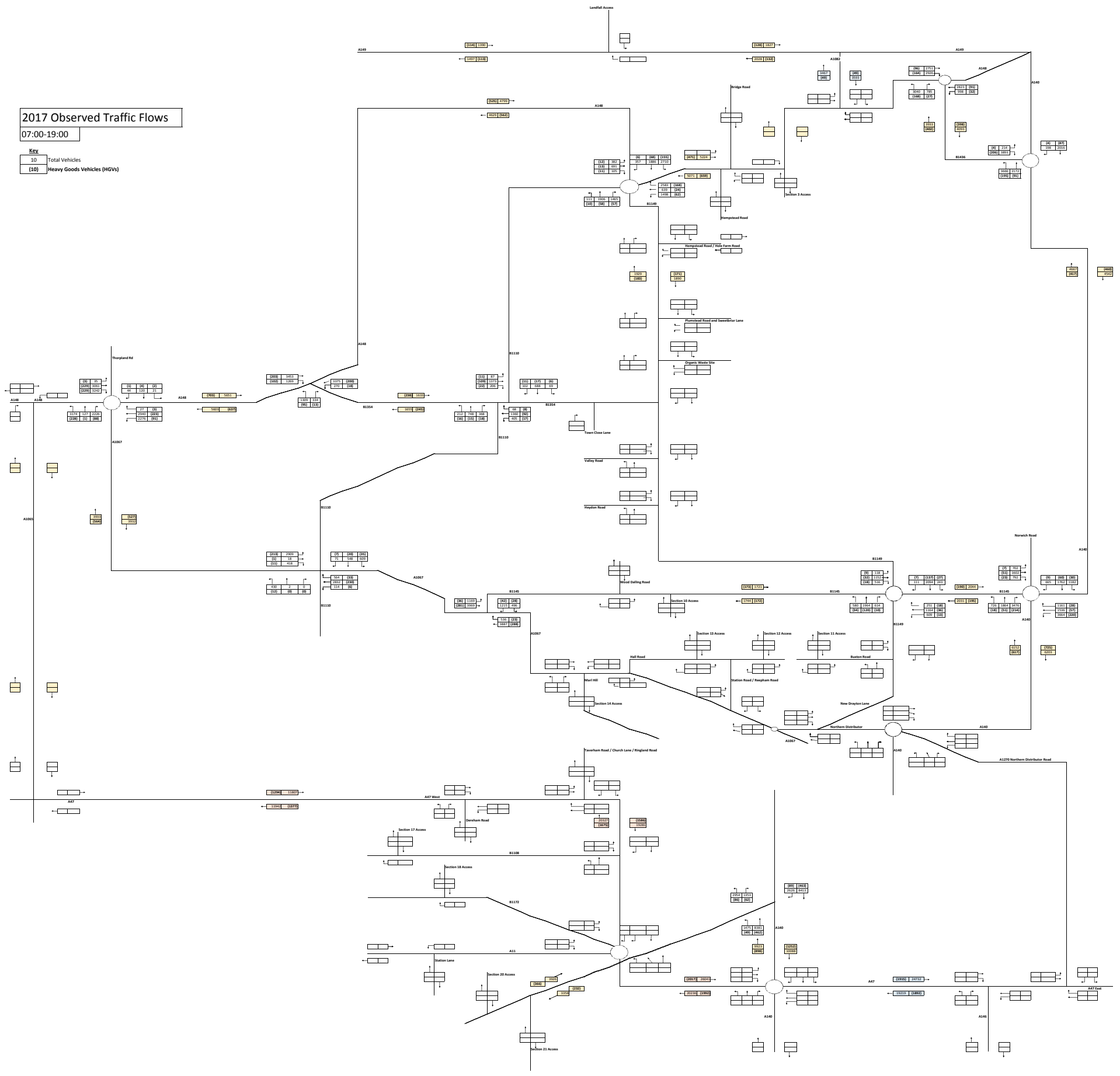

TEMPRO		
Average Weekly		
Thurs	1.10	growth 2017-2022
Principal	1.08	growth 2017-2022
Minor	1.09	growth 2017-2022

2022 Base Traffic Flows
07:00-19:00

Key
 10 Total Vehicles
 10 Heavy Goods Vehicles (HGVs)

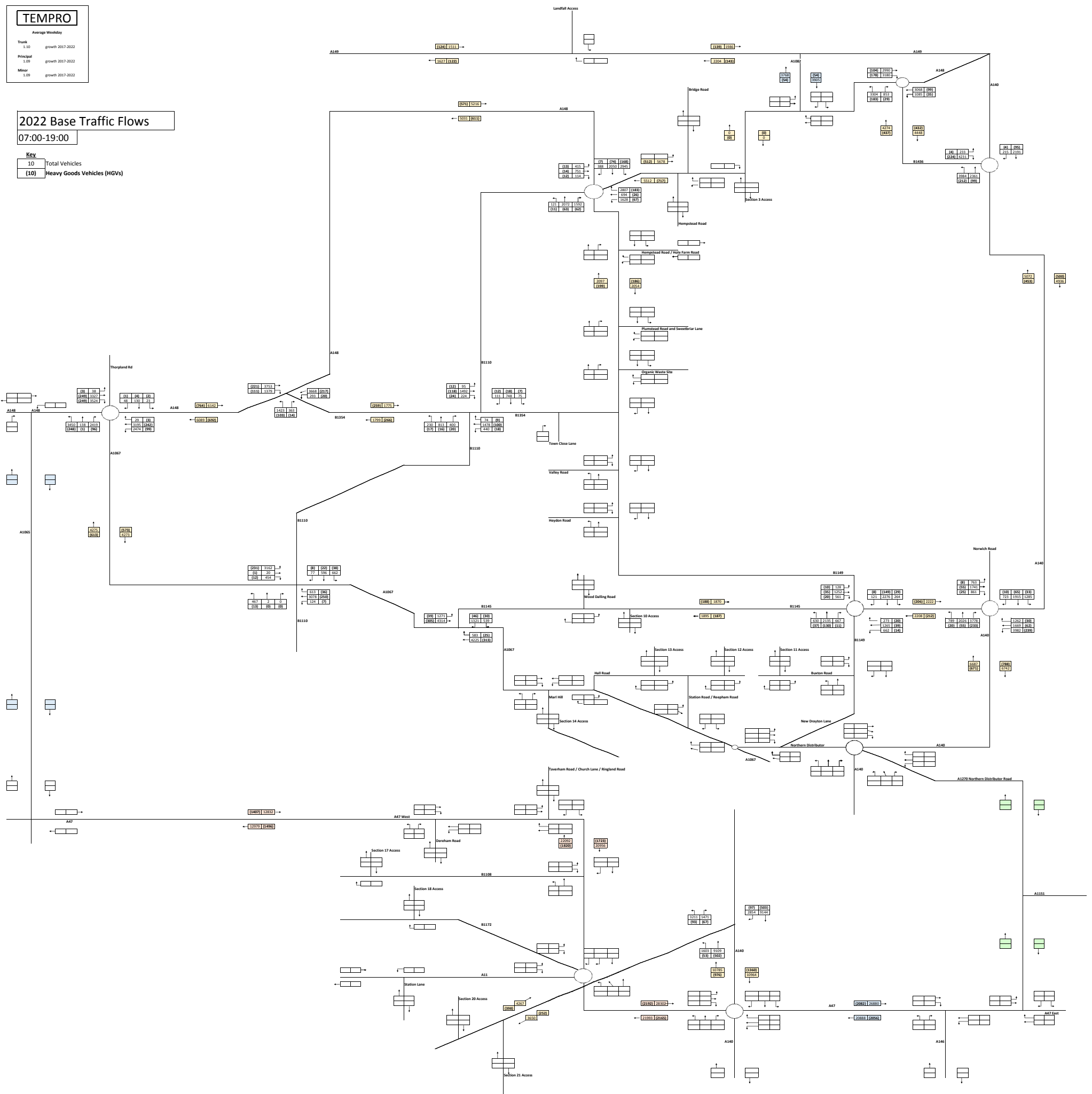

Tables Linked to Construction Vehicle Movements Spreadsheet

Route Section	Description	12hr Vehicle Flows			
		Total	HGV	Lights	Phase
1	Landfall to Holgate Hill	228	105	123	1
2	Holgate Hill to woodland north east of High Kelling	173	96	77	1
3	Woodland northeast of High Kelling to woodland south of Church Road	223	95	128	1
4	Woodland south of Church Road to woodland south and east of School Lane	163	94	69	1
5	Woodland east of School Lane to Plumstead Road	163	94	69	1
6	Plumstead Road to the B1149	233	106	128	2
7	B1149 to land South of Town Close Lane	173	96	77	-
8	Land south of Town Close Lane to woodland north of Reepham Road	260	94	167	2
9	Land north of Reepham Road to woodland north of Reepham	221	94	128	2
10	Woodland north of Reepham to woodland at Booton Common	212	96	116	2
11	Woodland east of Reepham to The Grove	193	97	96	2
12	The Grove to woodland south of Church Farm Lane	163	94	69	3
13	Woodland south of Church Farm Lane to River Wensum	192	96	96	3
14	River Wensum to woodland south west of Ringland	277	95	182	3
15	Woodland south west of Ringland to A47	173	101	72	3
16	A47 to Bawburgh Road	224	97	128	3
17	Bawburgh Road to woodland west of Little Melton	241	94	147	4
18	Woodland west of Little Melton to A11	316	96	221	4
19	A11 to woodland north west of Swardeston	191	95	96	4
20	Woodland north west of Swardeston to B1113	203	95	108	4
21	B1113 to end of cable route	267	140	128	4
Landfall	Landfall	15	5	10	
Booster Station	Booster Station	46	12	34	
Converter / Sub Station	Converter / Sub Station	111	29	82	
Total:		4,661	2,116	2,545	4,661

HGVs	25%	from Kings Lynn via A148	Staff Vehicle Movements	8%	via A148
Assume	25%	from Great Yarmouth	Assume	20%	via A47 east
	25%	from Lowestoft		11%	from A146
	50%	from A47		7%	from A47 west
	0%	from A1065		0%	from A1065
	50%	from A11		10%	from A11
	25%	from A140 south		13%	from A140 south
	0%	from A140 north		12%	from A140 north
	20%			100%	

123 Light Vehicles
105 Total HGVs

12hr Total Construction Traffic - Sensitivity Scenario
Route Section 1

Key	
10	Total Vehicles
(10)	Heavy Goods Vehicles (HGVs)

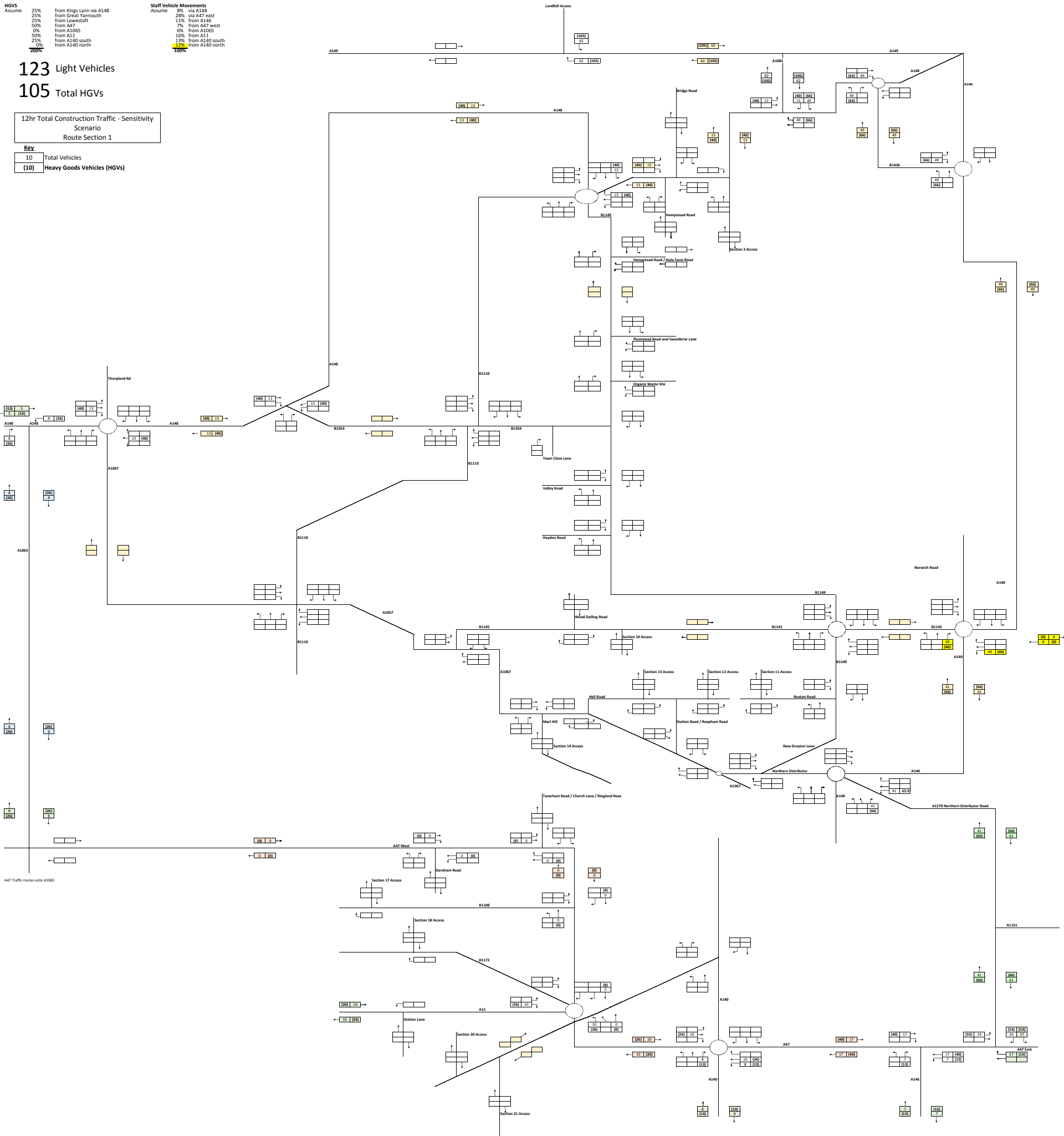

HGVs		Staff Vehicle Movements	
Assume	25%	Assume	8%
	from Kings Lynn via A148		via A148
	25%		28%
	from Great Yarmouth		via A47 east
	25%		11%
	from Lowestoft		from A146
	50%		7%
	from A47		from A47 west
	0%		6%
	from A1065		from A1065
	50%		16%
	from A11		from A11
	25%		13%
	from A140 south		from A140 south
	0%		12%
	from A140 north		from A140 north
	20%		10%

77 Light Vehicles
96 Total HGVs

12hr Total Construction Traffic - Sensitivity Scenario
 Route Section 2

Key	
10	Total Vehicles
(10)	Heavy Goods Vehicles (HGVs)

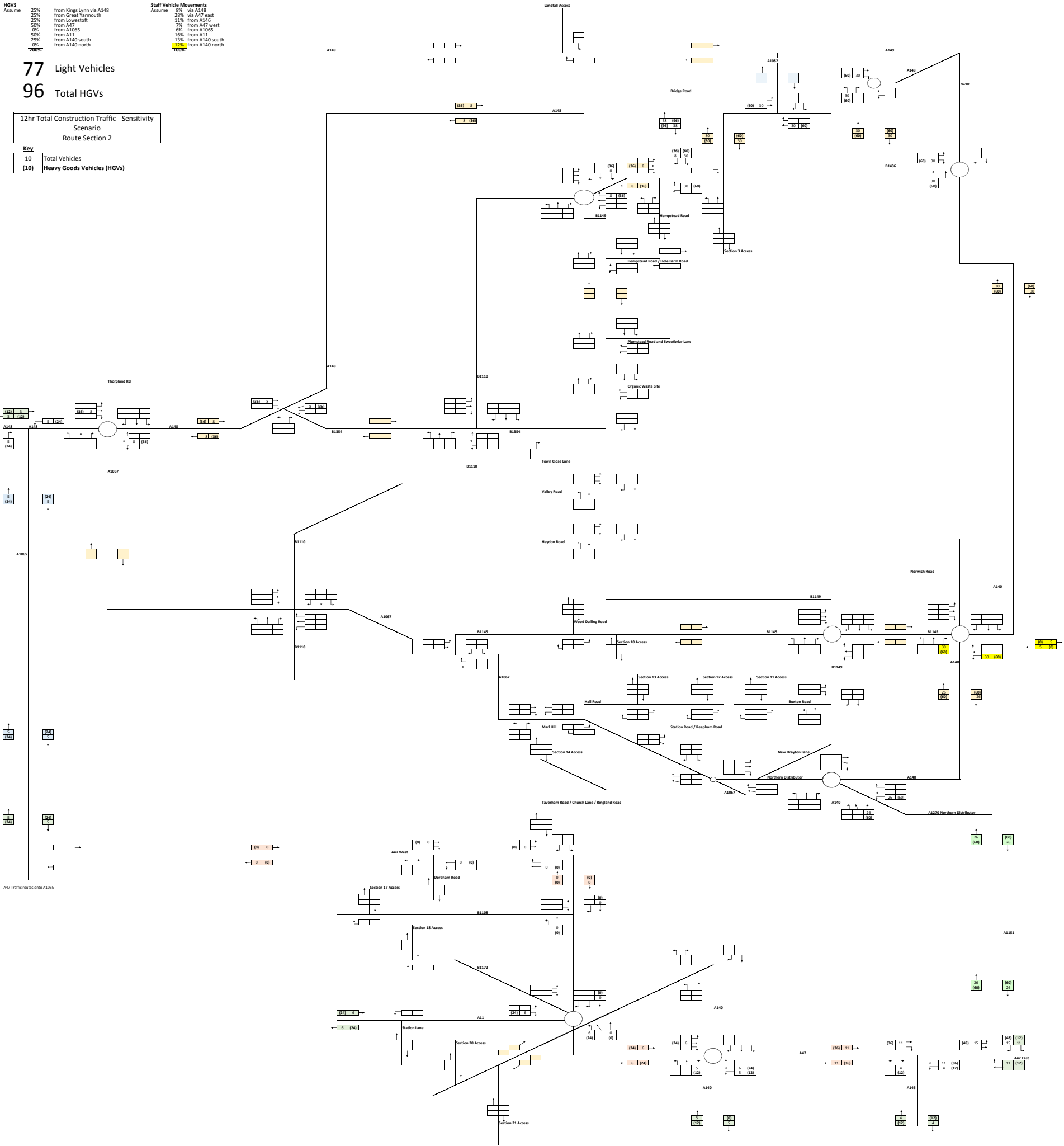

HGVs	25%	from Kings Lynn via A148	Staff Vehicle Movements	8%	via A148
Assume	25%	from Great Yarmouth	Assume	28%	via A27 east
	25%	from Lowestoft		11%	from A146
	50%	from A27		7%	from A27 west
	0%	from A1065		6%	from A1065
	50%	from A11		16%	from A11
	25%	from A140 south		13%	from A140 south
	0%	from A140 north		12%	from A140 north
	200%			100%	

128 Light Vehicles
95 Total HGVs

12hr Total Construction Traffic - Sensitivity Scenario
 Route Section 3

Key
10 Total Vehicles
(10) Heavy Goods Vehicles (HGVs)

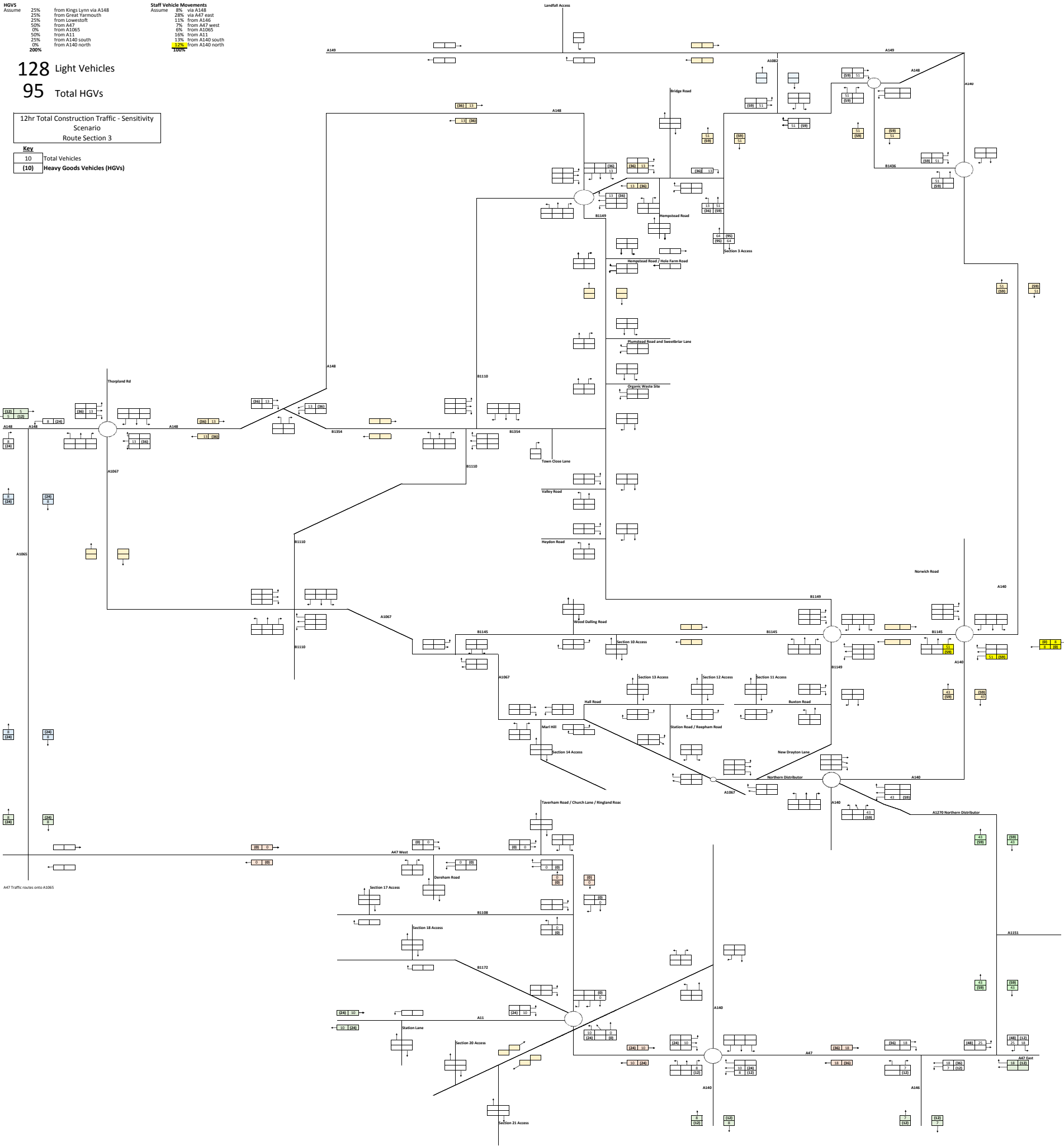

A27 Traffic routes onto A1065

HGVS		Staff Vehicle Movements	
Assume	25%	Assume	8%
	from Kings Lynn via A148		via A148
	25%		28%
	from Great Yarmouth		via A47 east
	25%		11%
	from Lowestoft		from A146
	50%		7%
	from A47		from A47 west
	0%		6%
	from A1065		from A1065
	50%		16%
	from A11		from A11
	25%		13%
	from A140 south		from A140 south
	0%		12%
	from A140 north		from A140 north
	200%		210%

69 Light Vehicles
94 Total HGVs

12hr Total Construction Traffic - Sensitivity Scenario
Route Section 4

Key	
10	Total Vehicles
(10)	Heavy Goods Vehicles (HGVs)

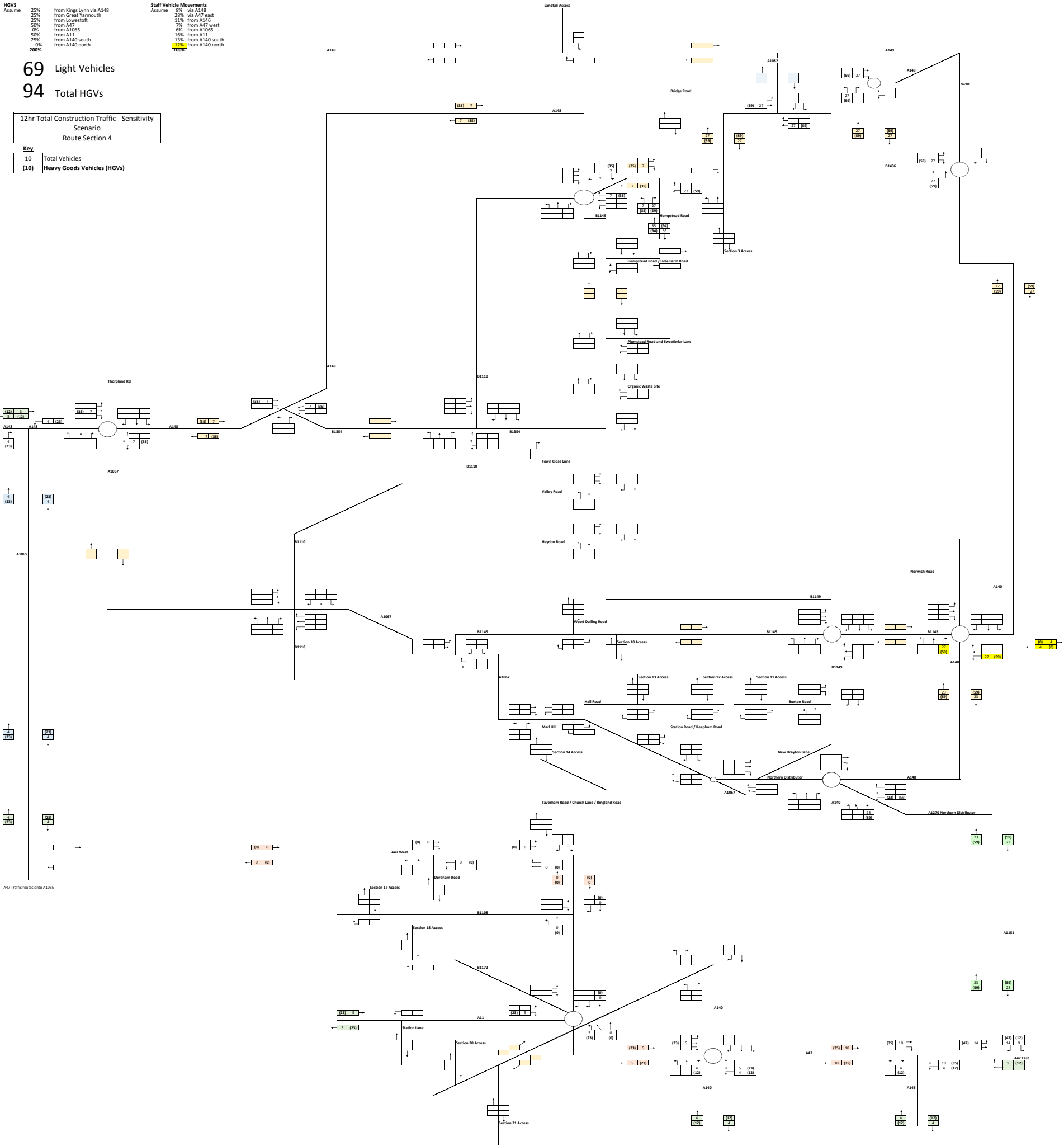

HGVs	25%	from Kings Lynn via A148	Staff Vehicle Movements	8%	via A148
Assume	25%	from Great Yarmouth	Assume	28%	via A27 east
	25%	from Lowestoft		11%	from A146
	50%	from A17		7%	from A27 west
	0%	from A1065		6%	from A1065
	50%	from A11		16%	from A11
	25%	from A140 south		13%	from A140 south
	0%	from A140 north		12%	from A140 north
	200%			100%	

69 Light Vehicles
94 Total HGVs

12hr Total Construction Traffic - Sensitivity Scenario
 Route Section 5

Key
10 Total Vehicles
(10) Heavy Goods Vehicles (HGVs)

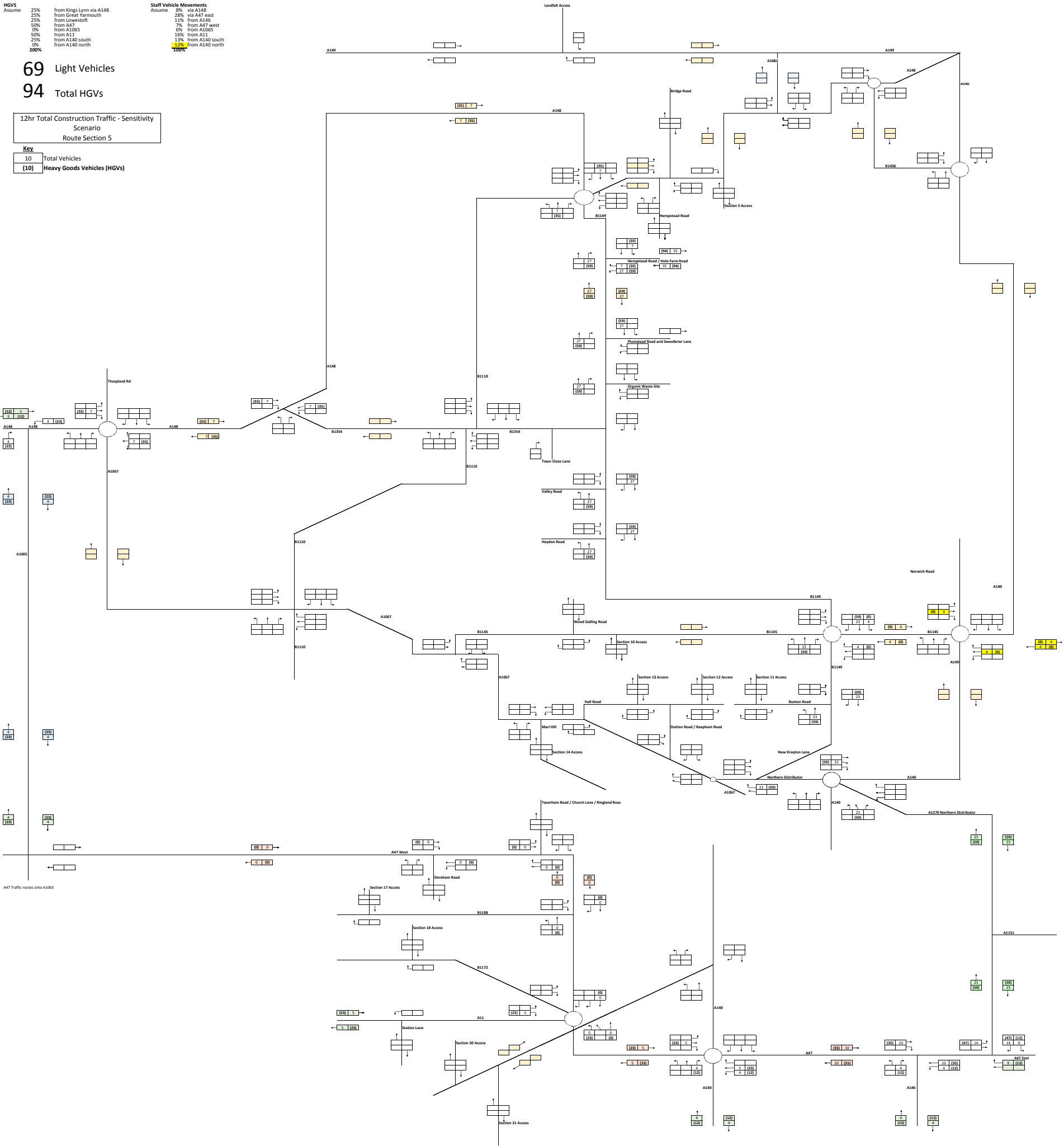

12hr Total Construction Traffic - Sensitivity Scenario Phase 1 Total

465 Light Vehicles

484 Total HGVs

949 Total Vehicles

Key
10 Total Vehicles
(10) Heavy Goods Vehicles (HGVs)

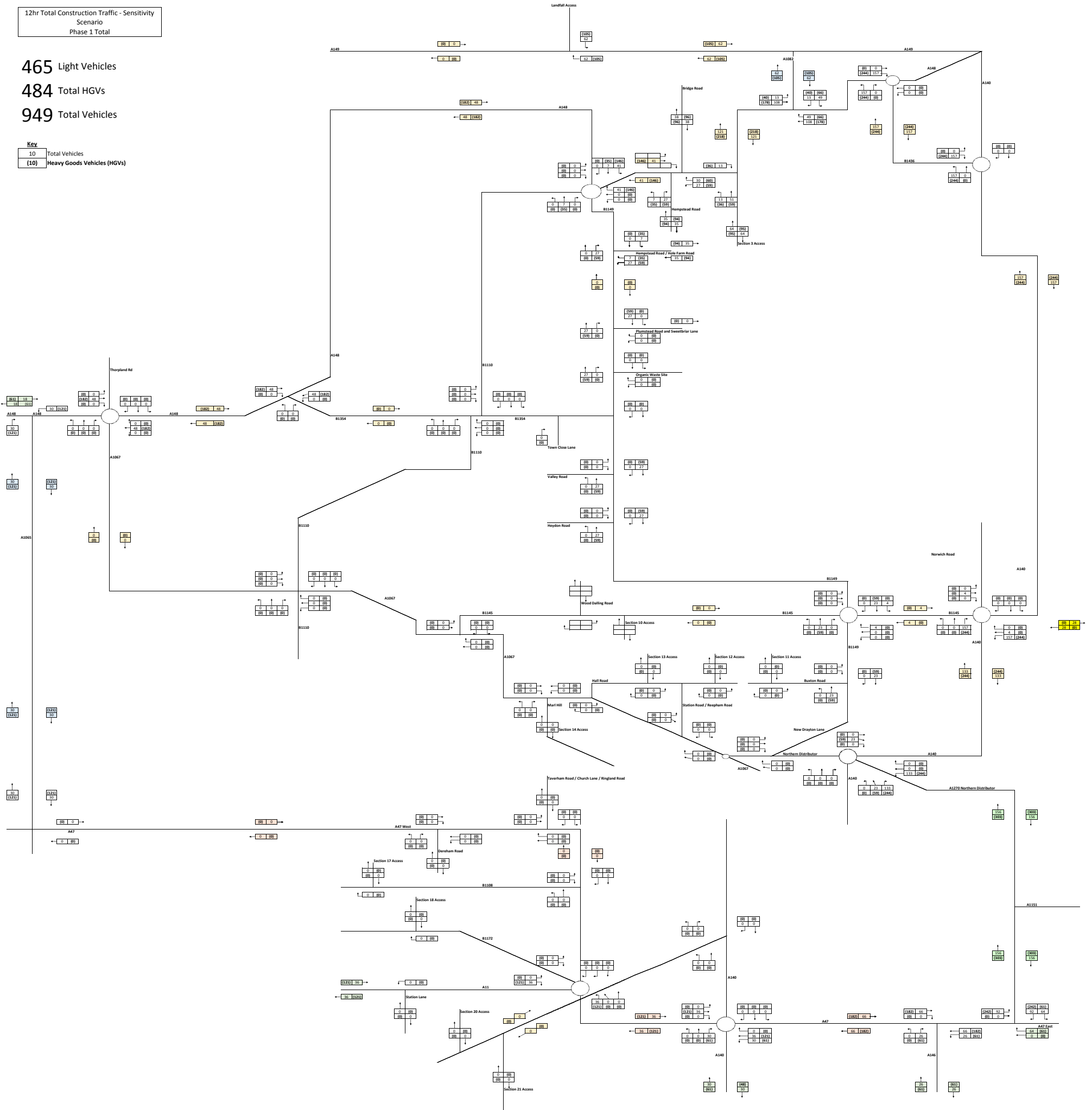

HGVS		Staff Vehicle Movements	
Assume	25%	Assume	8%
	from Kings Lynn via A148		via A148
	25%		28%
	from Great Yarmouth		via A47 east
	25%		11%
	from Lowestoft		from A146
	50%		7%
	from A47		from A47 west
	0%		6%
	from A1065		from A1065
	50%		10%
	from A11		from A11
	25%		13%
	from A140 south		from A140 south
	0%		12%
	from A140 north		from A140 north
	200%		100%

128 Light Vehicles
106 Total HGVs

12hr Total Construction Traffic - Sensitivity Scenario
 Route Section 6

Key	
10	Total Vehicles
(10)	Heavy Goods Vehicles (HGVs)

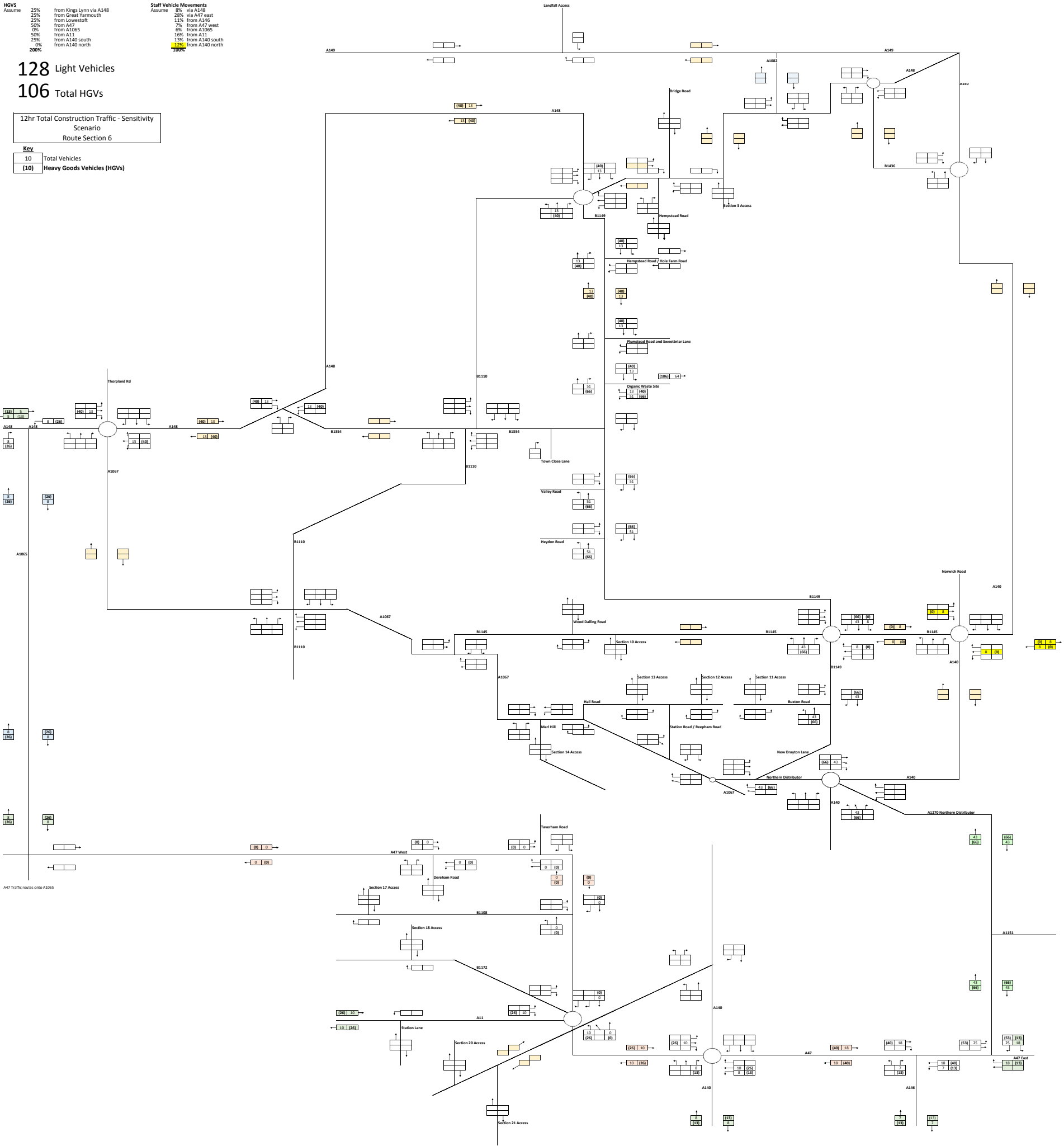

HGVS		Staff Vehicle Movements	
Assume	25%	Assume	8%
	from Kings Lynn via A148		via A148
	25%		28%
	from Great Yarmouth		via A47 east
	25%		11%
	from Lowestoft		from A146
	50%		7%
	from A47		from A47 west
	0%		6%
	from A1065		from A1065
	50%		10%
	from A11		from A11
	25%		13%
	from A140 south		from A140 south
	0%		12%
	from A140 north		from A140 north
	200%		100%

167 Light Vehicles
94 Total HGVs

12hr Total Construction Traffic - Sensitivity Scenario
 Route Section 8

Key
 10 Total Vehicles
 (10) Heavy Goods Vehicles (HGVs)

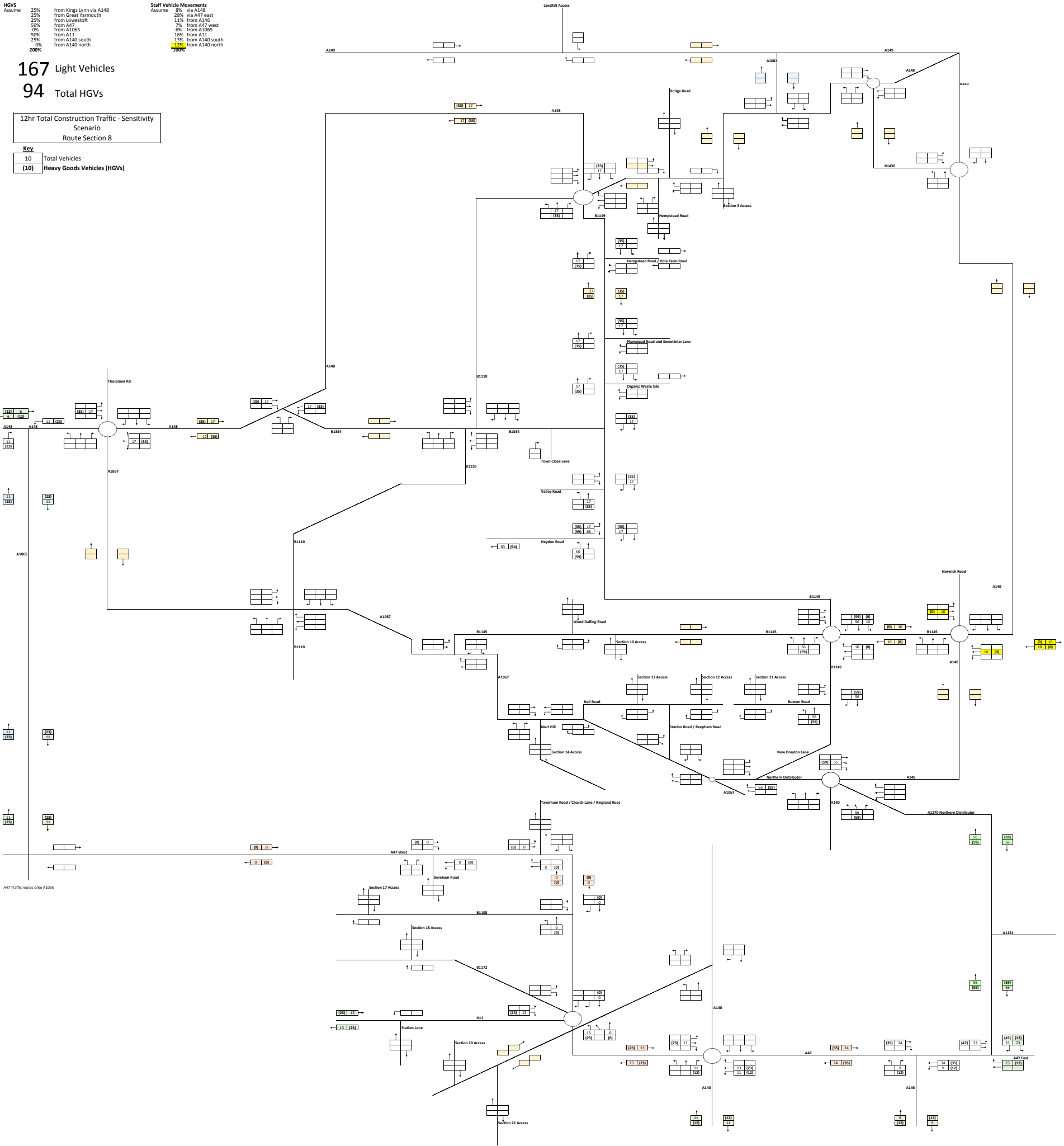

HGVS		Staff Vehicle Movements	
Assume	25%	Assume	25%
	from Kings Lynn via A148		via A148
	25%		28%
	from Great Yarmouth		via A47 east
	25%		11%
	from Lowestoft		from A146
	50%		7%
	from A47		from A47 west
	0%		6%
	from A1065		from A1065
	50%		10%
	from A11		from A11
	25%		13%
	from A140 south		from A140 south
	0%		12%
	from A140 north		from A140 north
	200%		100%

128 Light Vehicles
94 Total HGVs

12hr Total Construction Traffic - Sensitivity Scenario
 Route Section 9

Key	
10	Total Vehicles
(10)	Heavy Goods Vehicles (HGVs)

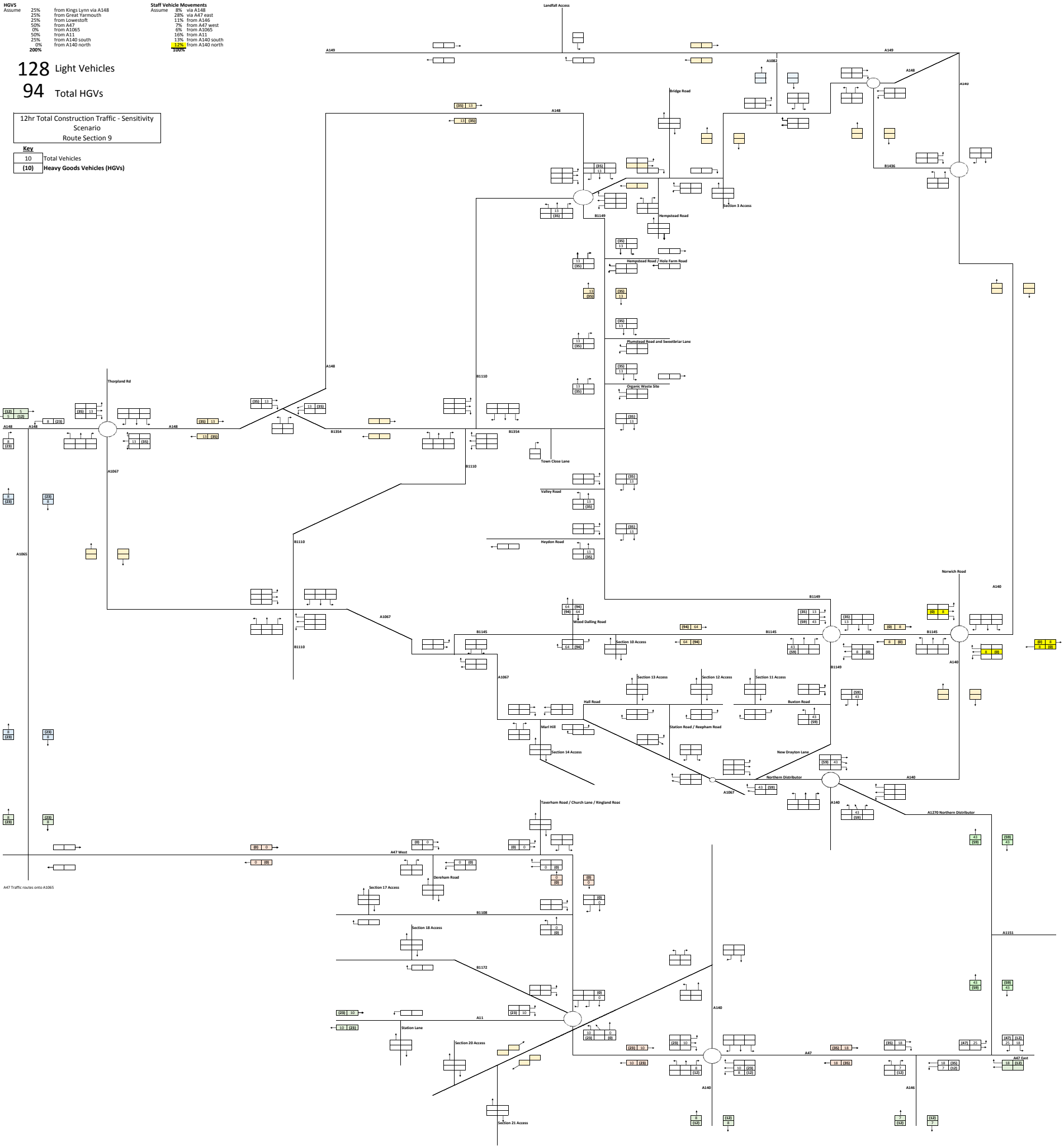

HGVs		
Assume	25%	from Kings Lynn via A148
	25%	from Great Yarmouth
	25%	from Lowestoft
	50%	from A47
	0%	from A1005
	50%	from A11
	25%	from A140 south
	0%	from A140 north
	200%	

Staff Vehicle Movements		
Assume	8%	via A148
	28%	via A47 east
	11%	from A146
	7%	from A47 west
	6%	from A1005
	10%	from A11
	13%	from A140 south
	12%	from A140 north
	100%	

116 Light Vehicles

96 Total HGVs

12hr Total Construction Traffic - Sensitivity Scenario
Route Section 10

Key
10 Total Vehicles
(10) Heavy Goods Vehicles (HGVs)

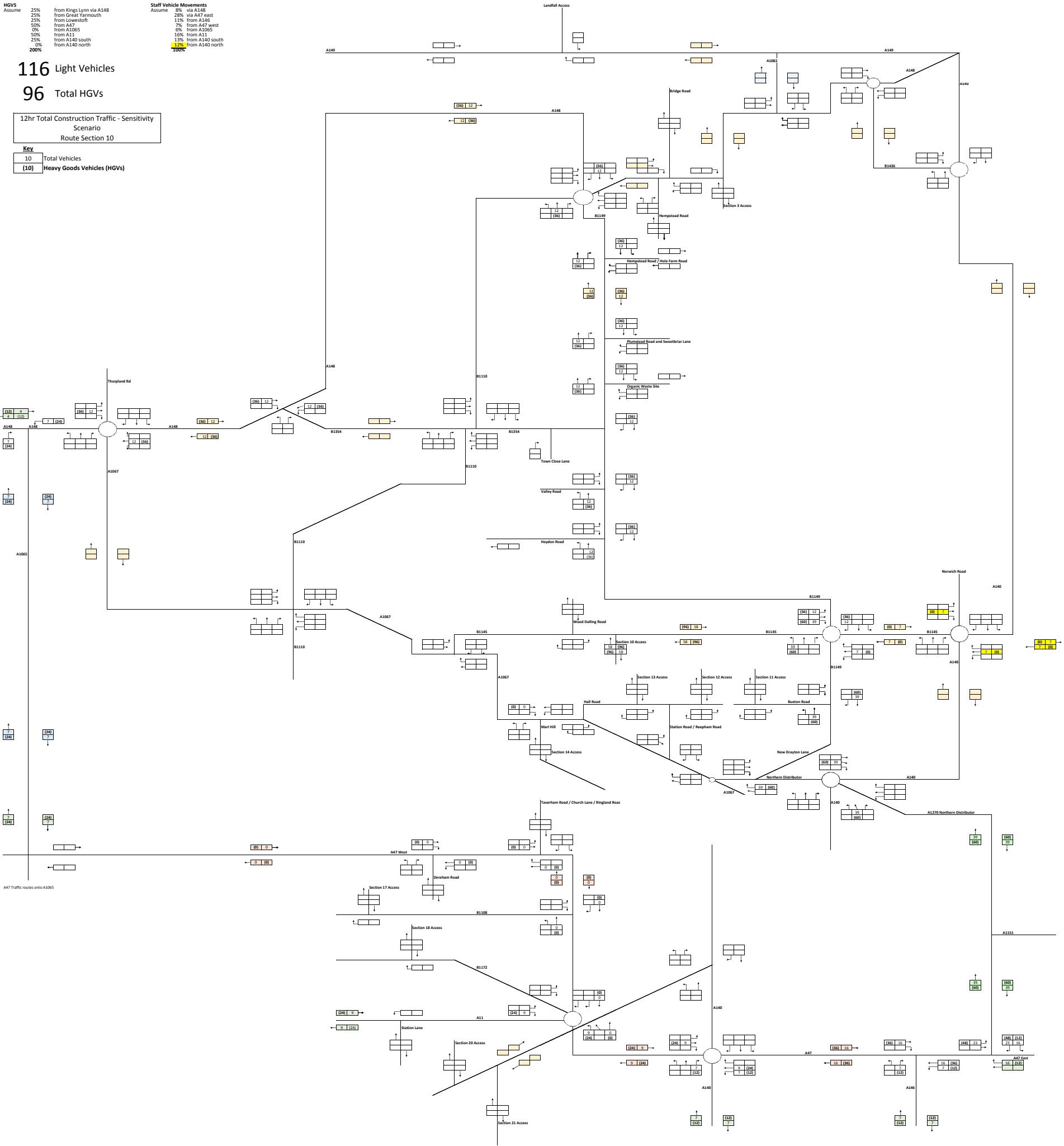

HGVs	25%	from Kings Lynn via A148	Staff Vehicle Movements	28%	via A148
Assume	25%	from Great Yarmouth	Assume	13%	from A146
	25%	from Lowestoft		7%	from A147 west
	50%	from A105		6%	from A105
	0%	from A11		10%	from A11
	25%	from A140 south		13%	from A140 south
	0%	from A140 north		12%	from A140 north
	200%			100%	

96 Light Vehicles
97 Total HGVs

12hr Total Construction Traffic - Sensitivity Scenario
 Route Section 11

Key
10 Total Vehicles
(10) Heavy Goods Vehicles (HGVs)

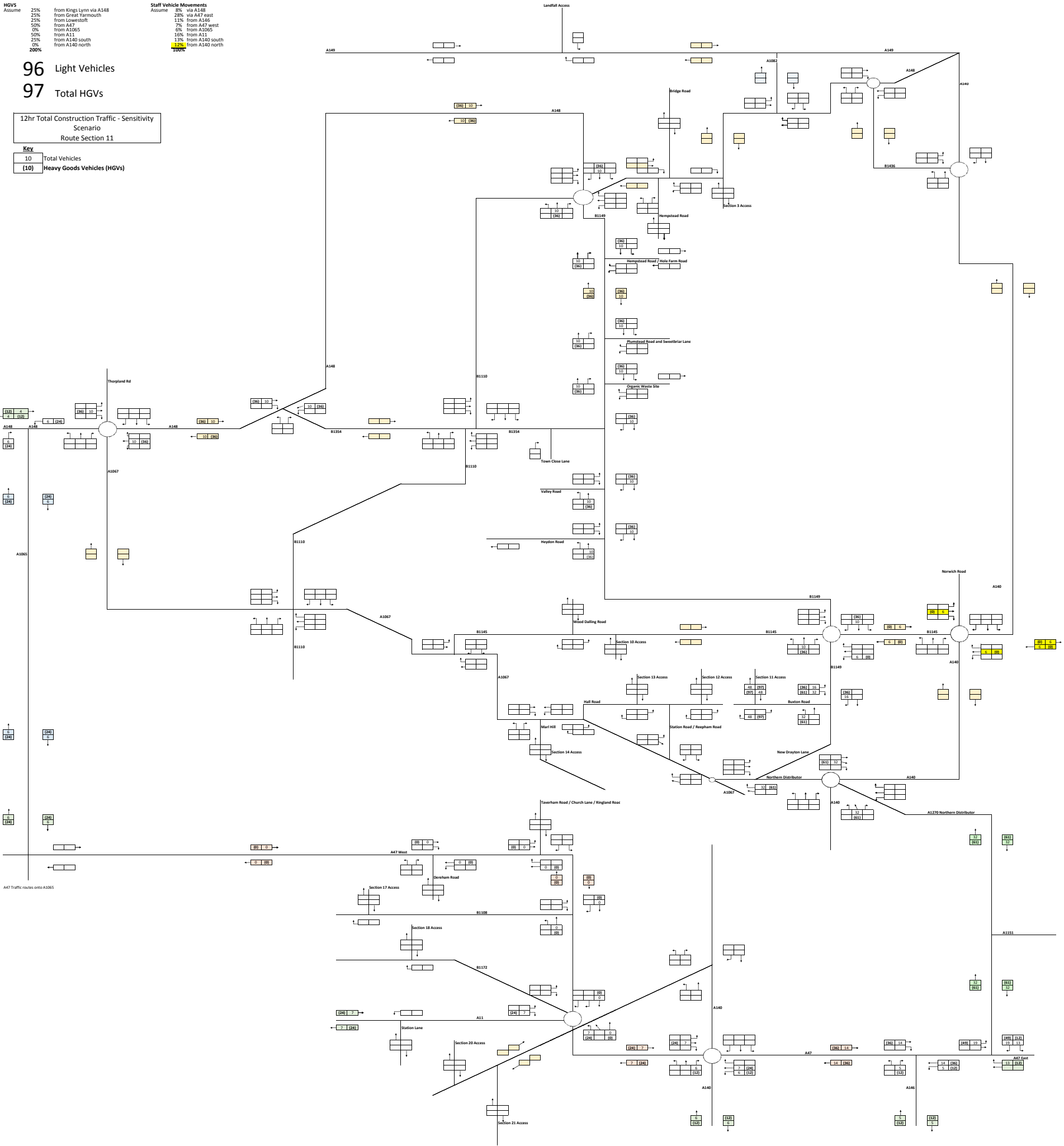

12hr Total Construction Traffic - Sensitivity Scenario
Phase 2 Total

633 Light Vehicles

486 Total HGVs

Total Vehicles

Key	
10	Total Vehicles
(10)	Heavy Goods Vehicles (HGVs)

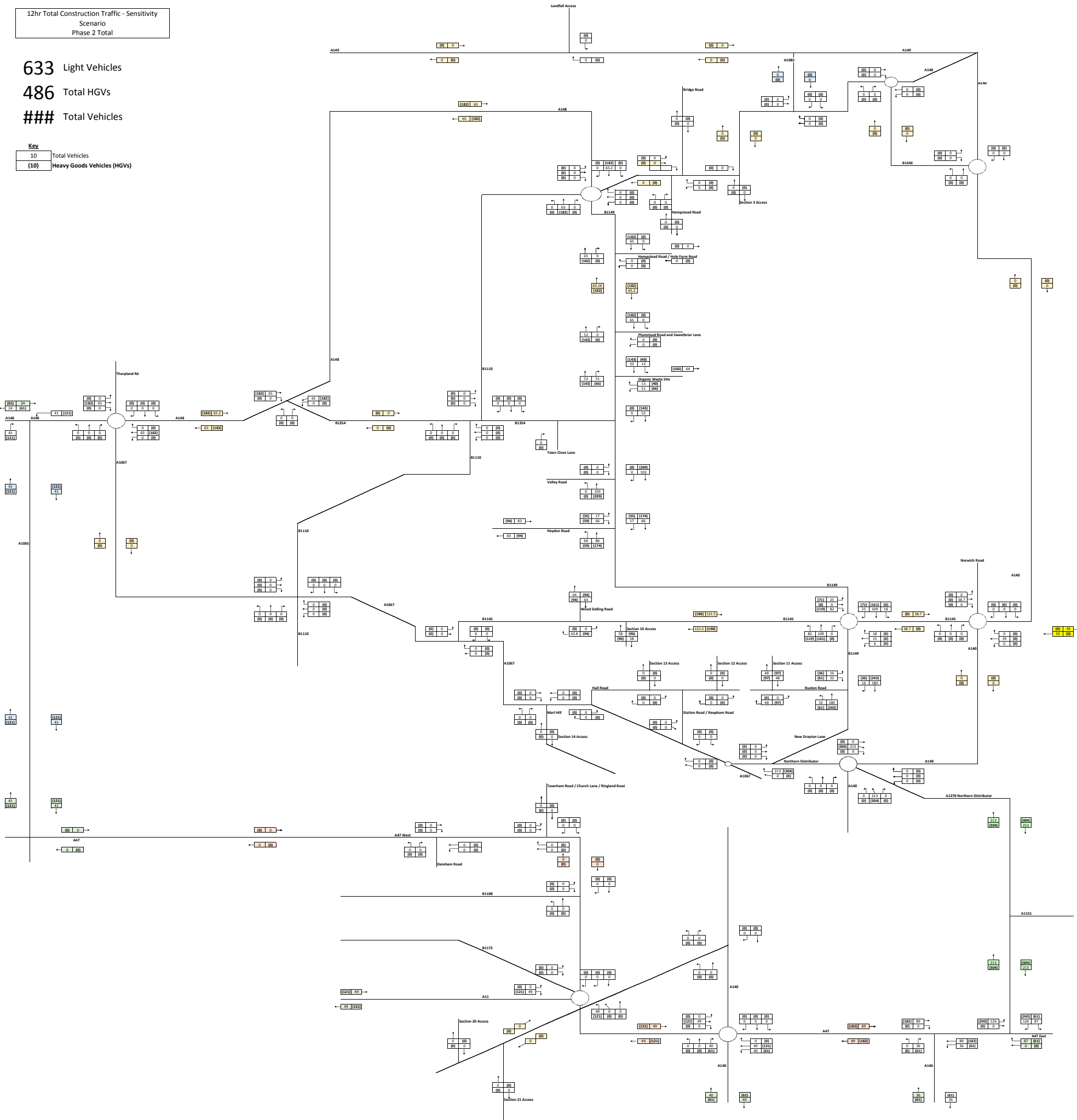

HGVS		Staff Vehicle Movements	
Assume	25%	Assume	8%
	from Kings Lynn via A148		via A148
	25%		28%
	from Great Yarmouth		via A47 east
	25%		11%
	from Lowestoft		from A146
	50%		7%
	from A47		from A47 west
	0%		6%
	from A1065		from A1065
	50%		16%
	from A11		from A11
	25%		13%
	from A140 south		from A140 south
	0%		12%
	from A140 north		from A140 north
	200%		100%

69 Light Vehicles
94 Total HGVs

12hr Total Construction Traffic - Sensitivity Scenario
Route Section 12

Key	
10	Total Vehicles
(10)	Heavy Goods Vehicles (HGVs)

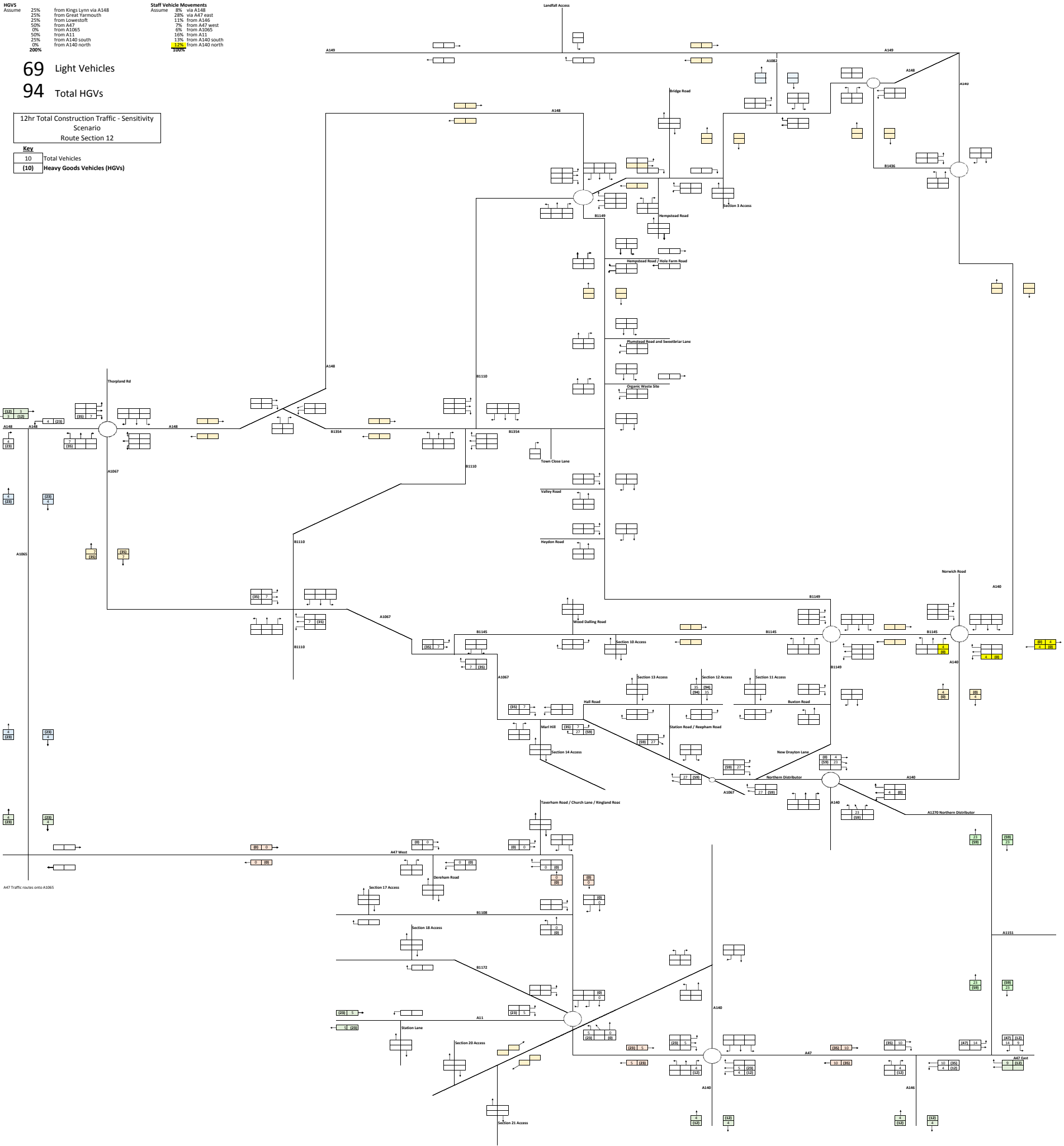

HGVS		Staff Vehicle Movements	
Assume	25%	Assume	25%
	from Kings Lynn via A148		via A148
	25%		28%
	from Great Yarmouth		via A47 east
	25%		11%
	from Lowestoft		from A146
	50%		7%
	from A47		from A47 west
	0%		6%
	from A1065		from A1065
	50%		10%
	from A11		from A11
	25%		13%
	from A140 south		from A140 south
	0%		12%
	from A140 north		from A140 north
	200%		100%

96 Light Vehicles

96 Total HGVs

12hr Total Construction Traffic - Sensitivity Scenario
Route Section 13

Key	
10	Total Vehicles
(10)	Heavy Goods Vehicles (HGVs)

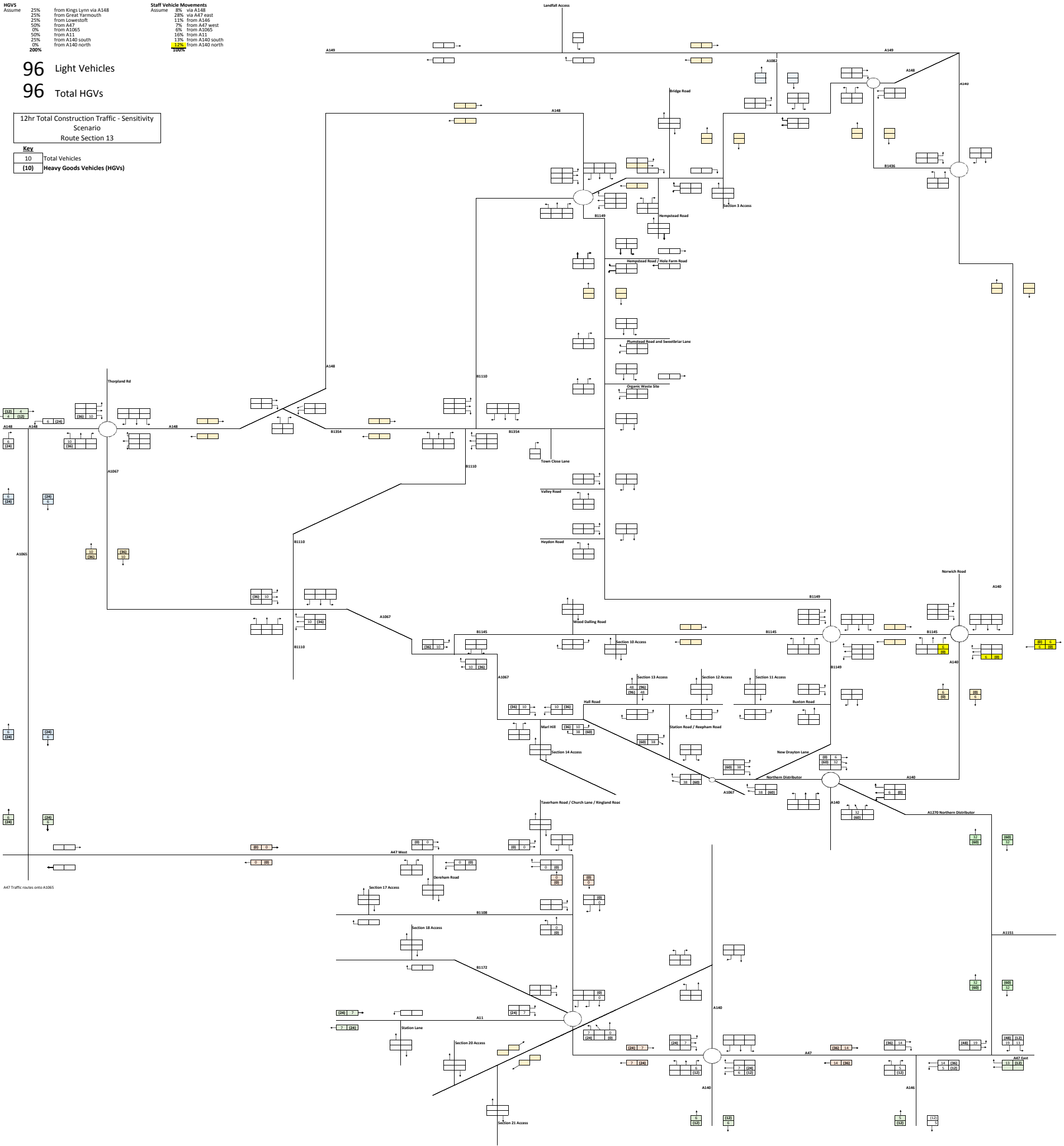

HGV5		Staff Vehicle Movements	
Assume	From	Assume	From
25%	from Kings Lynn via A148	28%	via A148
25%	from Great Yarmouth	28%	via A47 east
25%	from Lowestoft	11%	from A146
50%	from A47	7%	from A47 west
0%	from A1065	6%	from A1065
50%	from A11	10%	from A11
25%	from A140 south	13%	from A140 south
0%	from A140 north	12%	from A140 north
200%		120%	

Staff Vehicle Movements	
Assume	From
28%	via A148
28%	via A47 east
11%	from A146
7%	from A47 west
6%	from A1065
10%	from A11
13%	from A140 south
12%	from A140 north
120%	

182 Light Vehicles
95 Total HGVs

12hr Total Construction Traffic - Sensitivity Scenario
 Route Section 14

Key	
10	Total Vehicles
10	Heavy Goods Vehicles (HGVs)

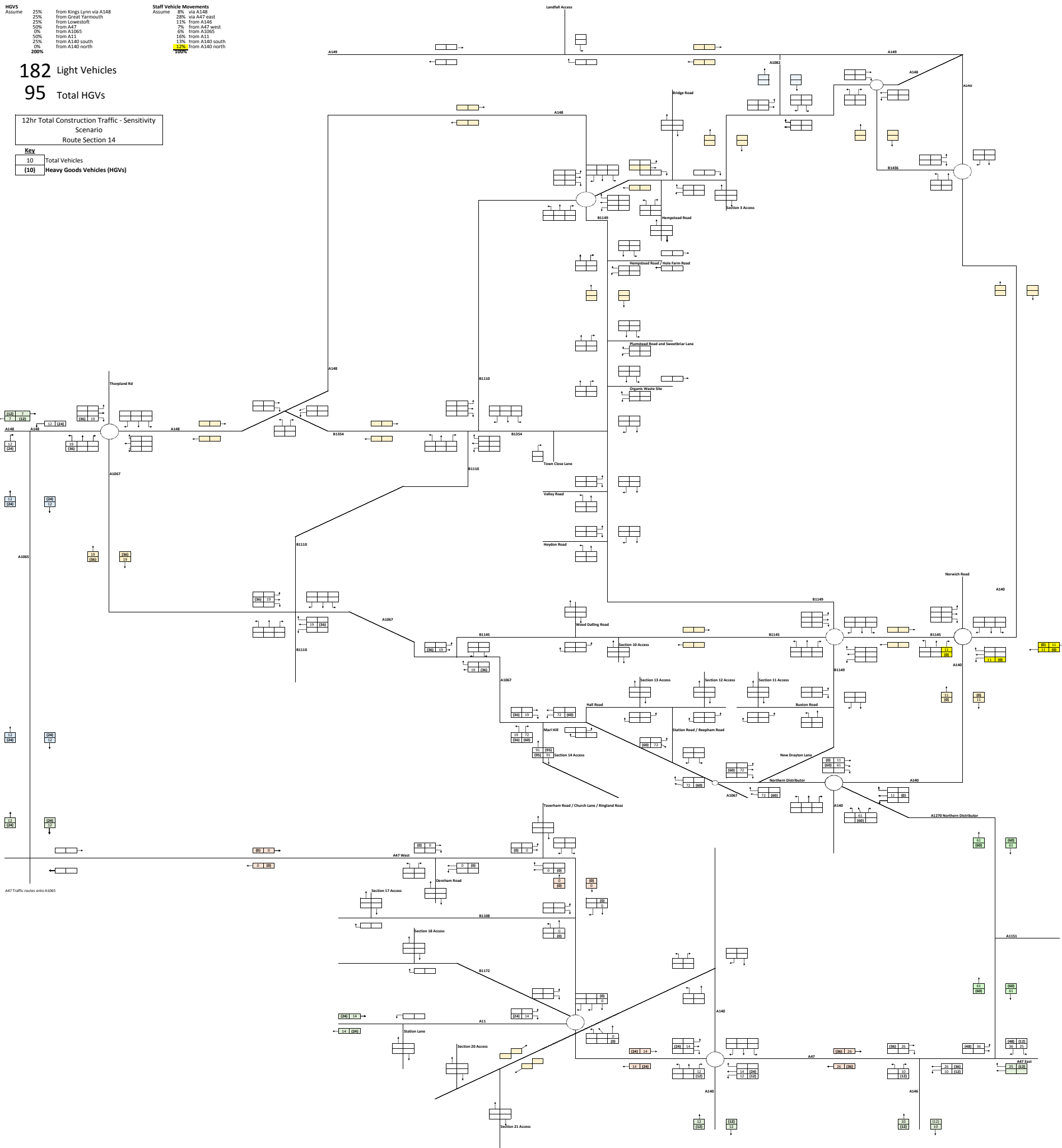

HGVs		Staff Vehicle Movements	
Assume	25%	Assume	0%
	from Kings Lynn via A148		via A148
	25%		28%
	from Great Yarmouth		via A47 east
	25%		11%
	from Lowestoft		from A146
	50%		7%
	from A47		from A47 west
	0%		6%
	from A1205		from A1205
	50%		16%
	from A11		from A11
	25%		33%
	from A140 south		from A140 south
	0%		12%
	from A140 north		from A140 north
	200%		11%

72 Light Vehicles
101 Total HGVs

12hr Total Construction Traffic - Sensitivity Scenario
 Route Section 15

Key
 10 Total Vehicles
 (10) Heavy Goods Vehicles (HGVs)

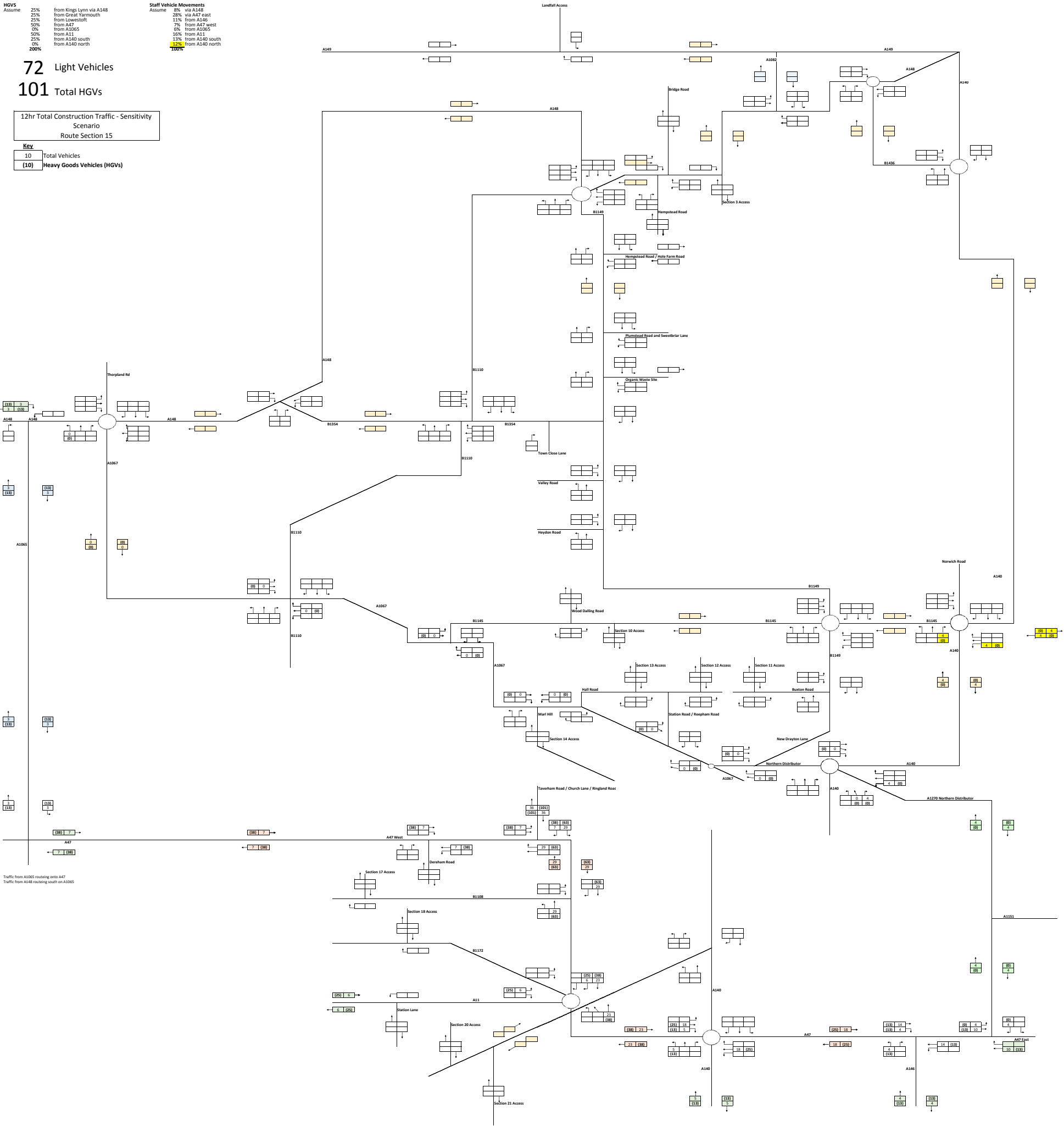

Traffic from A1205 routing onto A47
 Traffic from A148 routing south on A1205

HGVS		Staff Vehicle Movements	
Assume	25%	Assume	8%
	25%		28%
	25%		11%
	50%		7%
	0%		6%
	50%		16%
	25%		3%
	200%		12%
			100%

128 Light Vehicles
97 Total HGVs

12hr Total Construction Traffic - Sensitivity Scenario
 Route Section 16

Key	
10	Total Vehicles
(10)	Heavy Goods Vehicles (HGVs)

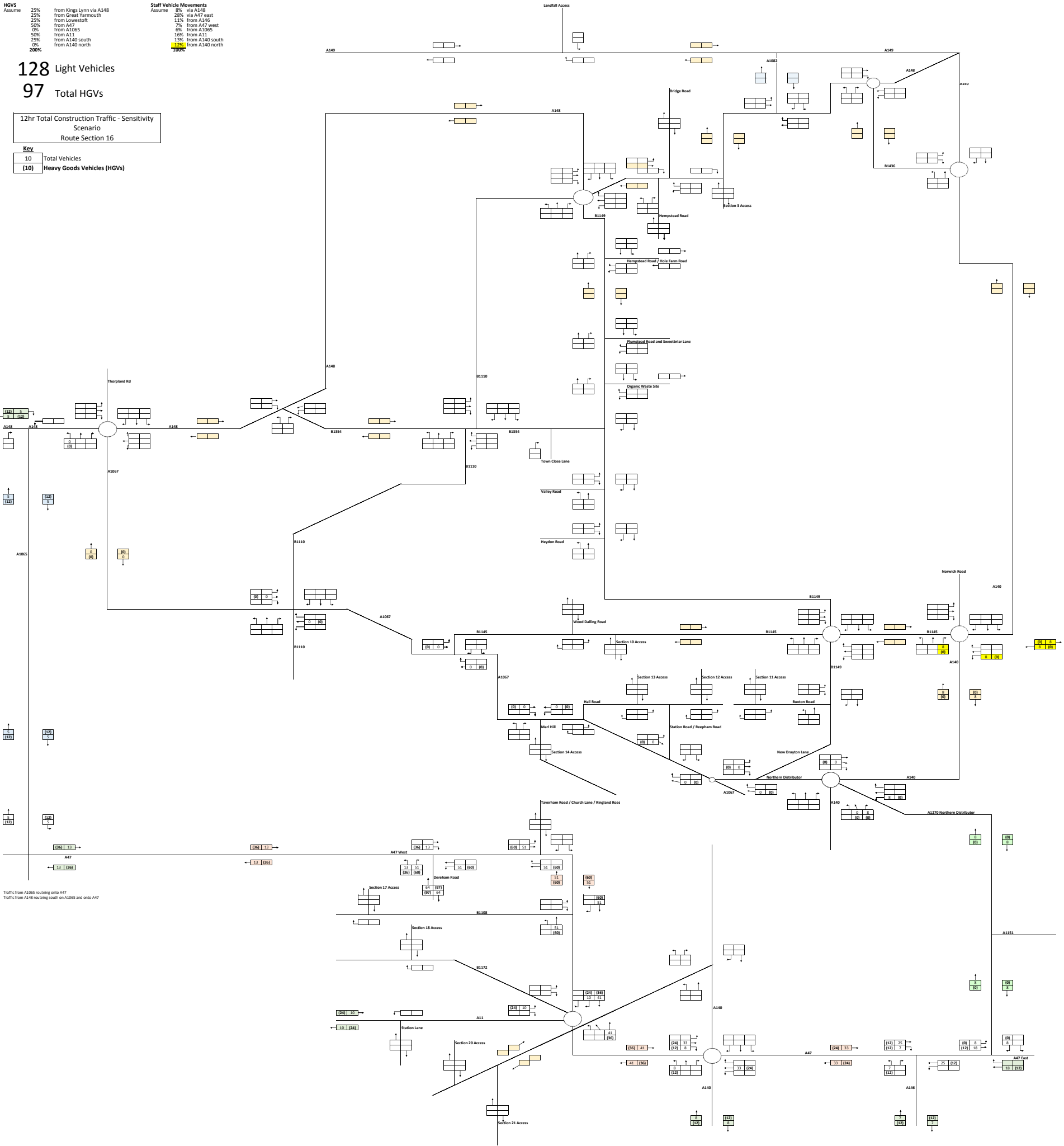

Traffic from A148 routing onto A47
 Traffic from A148 routing south on A1065 and onto A47

12hr Total Construction Traffic - Sensitivity Scenario Phase 3 Total

546 Light Vehicles

483 Total HGVs

Total Vehicles

Key
10 Total Vehicles
10 Heavy Goods Vehicles (HGVs)

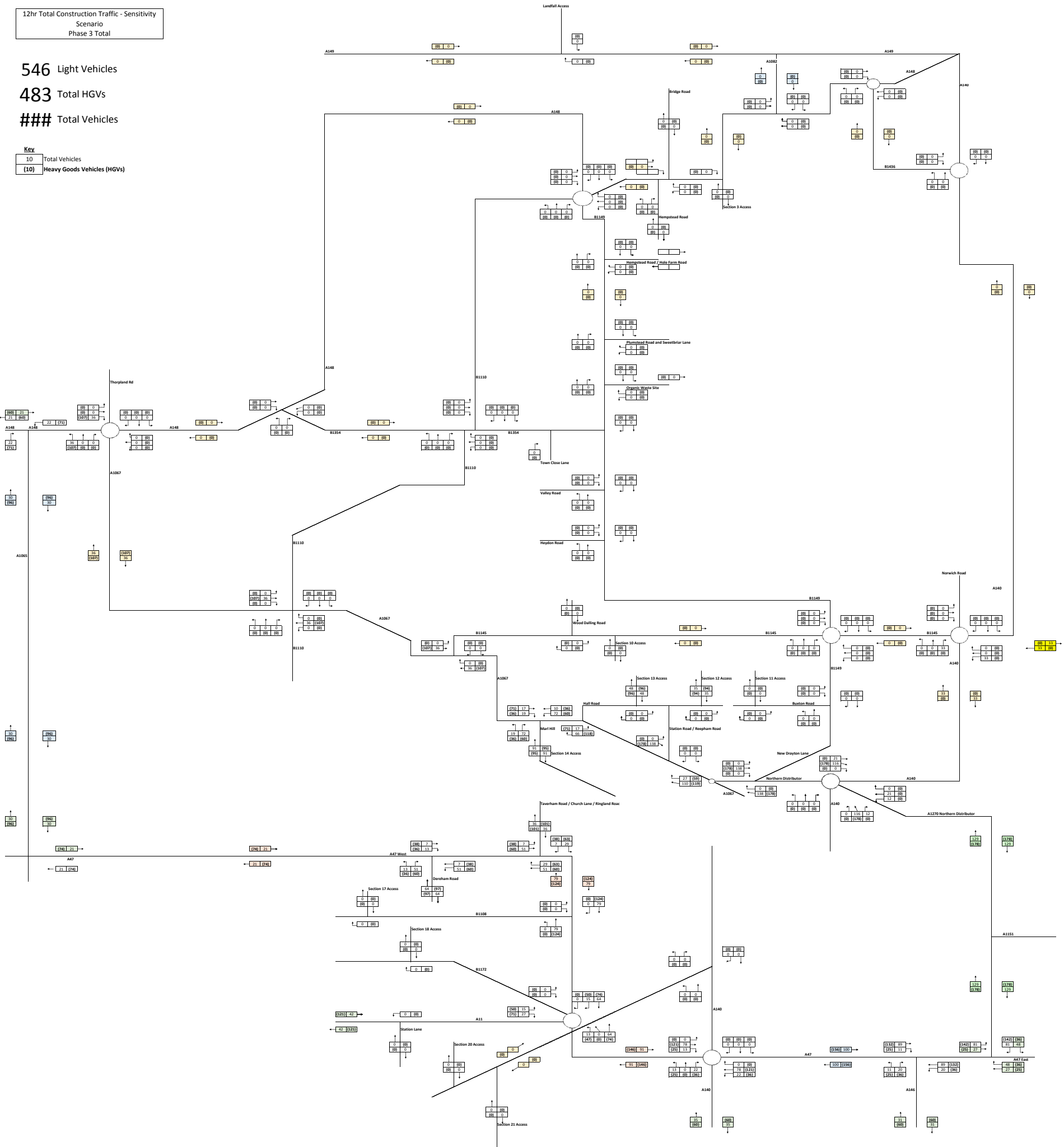

HGVS		Staff Vehicle Movements	
Assume	25%	Assume	8%
	from Kings Lynn via A148		via A148
	25%		28%
	from Great Yarmouth		via A47 east
	25%		11%
	from Lowestoft		from A146
	50%		7%
	from A47		from A47 west
	0%		6%
	from A1065		from A1065
	50%		10%
	from A11		from A11
	25%		13%
	from A140 south		from A140 south
	0%		12%
	from A140 north		from A140 north
	200%		100%

147 Light Vehicles
94 Total HGVs

12hr Total Construction Traffic - Sensitivity Scenario
 Route Section 17

Key	
10	Total Vehicles
(10)	Heavy Goods Vehicles (HGVs)

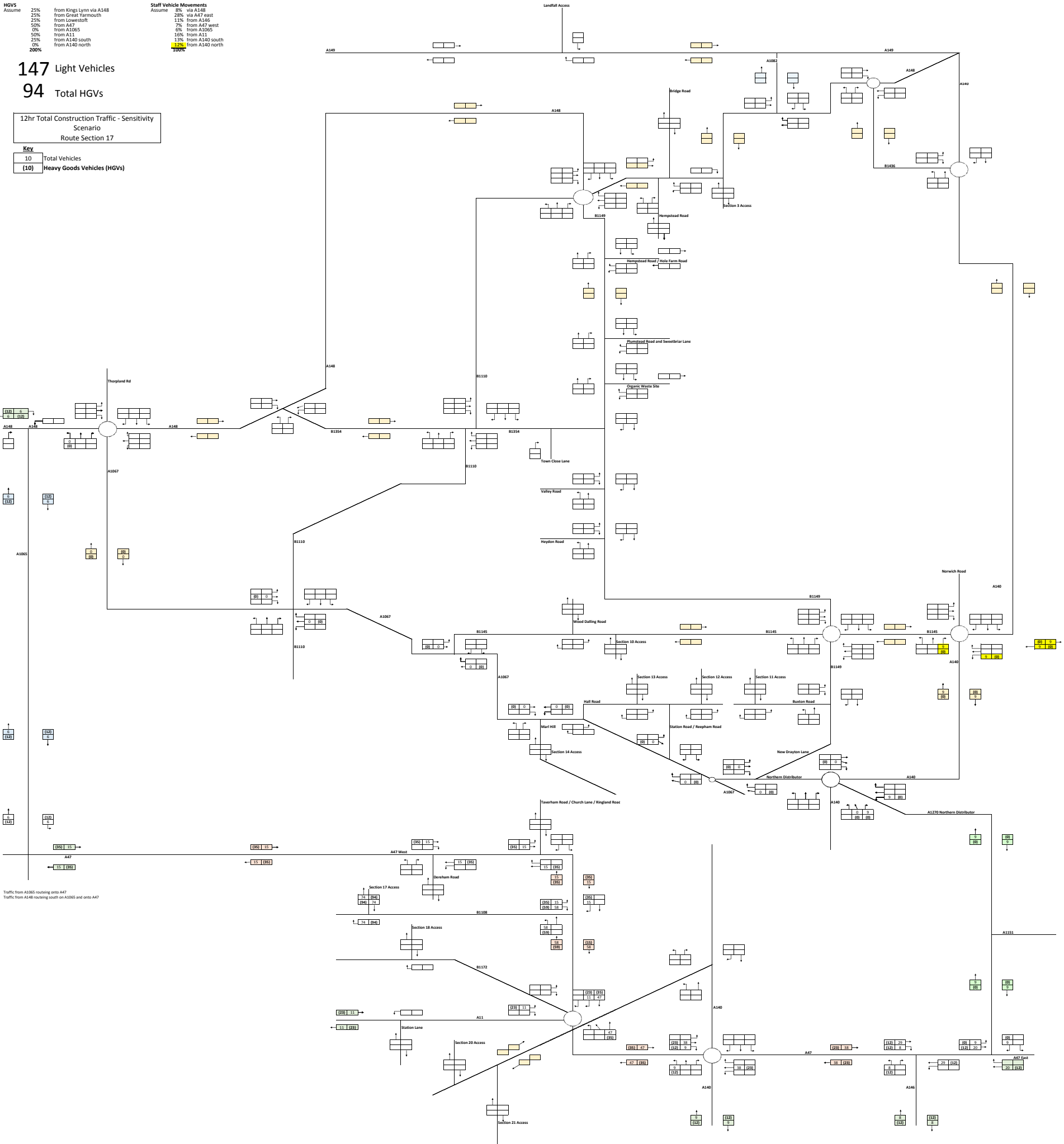

Traffic from A1065 reaching onto A47
 Traffic from A148 reaching south on A1065 and onto A47

HGVs		Staff Vehicle Movements	
Assume	25%	Assume	8%
	25%		28%
	25%		11%
	50%		7%
	0%		6%
	50%		16%
	25%		3%
	200%		12%
			100%

221 Light Vehicles
96 Total HGVs

12hr Total Construction Traffic - Sensitivity Scenario
Route Section 18

Key	
10	Total Vehicles
(10)	Heavy Goods Vehicles (HGVs)

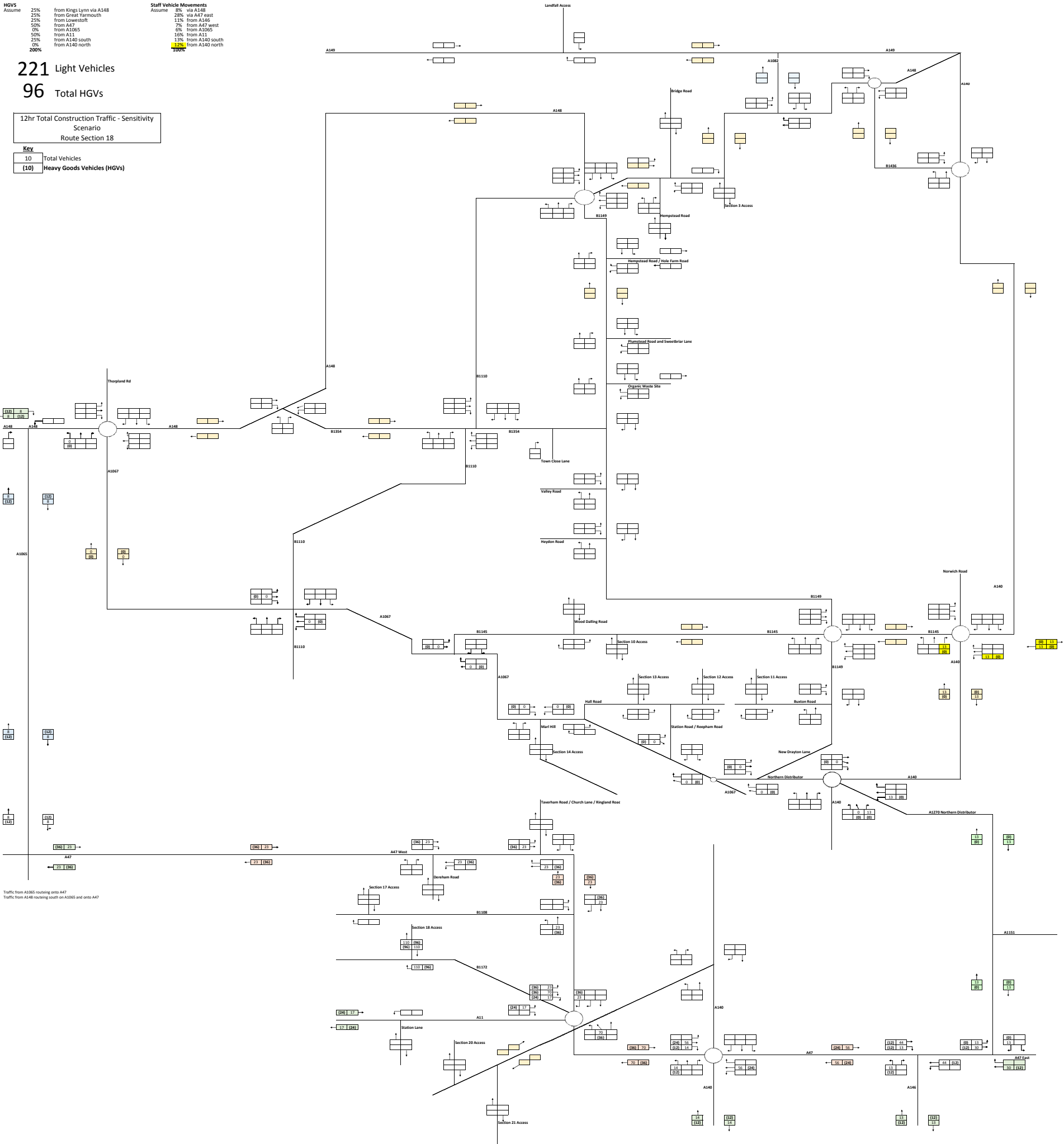

Traffic from A1065 routing onto A47
Traffic from A148 routing south on A1065 and onto A47

HGVS		Staff Vehicle Movements	
Assume	25%	Assume	8%
	25%		28%
	25%		11%
	50%		7%
	0%		6%
	50%		16%
	25%		3%
	0%		12%
	200%		100%

96 Light Vehicles
95 Total HGVs

12hr Total Construction Traffic - Sensitivity Scenario
Route Section 19

Key	
10	Total Vehicles
(10)	Heavy Goods Vehicles (HGVs)

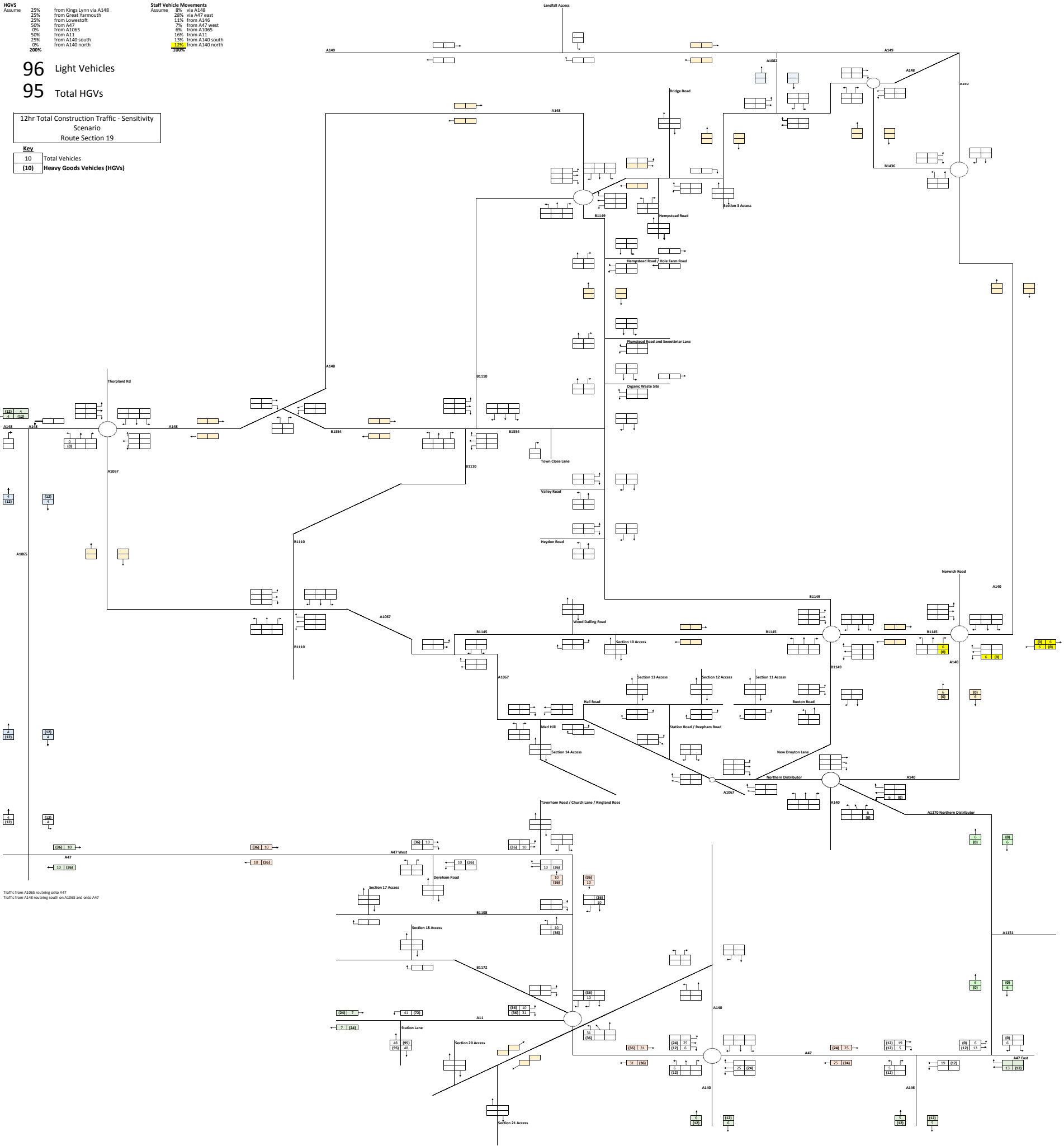

Traffic from A1065 routing onto A47
Traffic from A148 routing onto A1065 and onto A47

HGVS		Staff Vehicle Movements	
Assume	25%	Assume	8%
	from Kings Lynn via A148		via A148
	25%		28%
	from Great Yarmouth		via A47 east
	25%		11%
	from Lowestoft		from A146
	50%		7%
	from A47		6%
	0%		10%
	from A1065		3%
	50%		10%
	from A11		13%
	25%		from A140 south
	0%		12%
	from A140 south		from A140 north
	200%		100%

108 Light Vehicles
95 Total HGVs

12hr Total Construction Traffic - Sensitivity Scenario
Route Section 20

Key	
10	Total Vehicles
(10)	Heavy Goods Vehicles (HGVs)

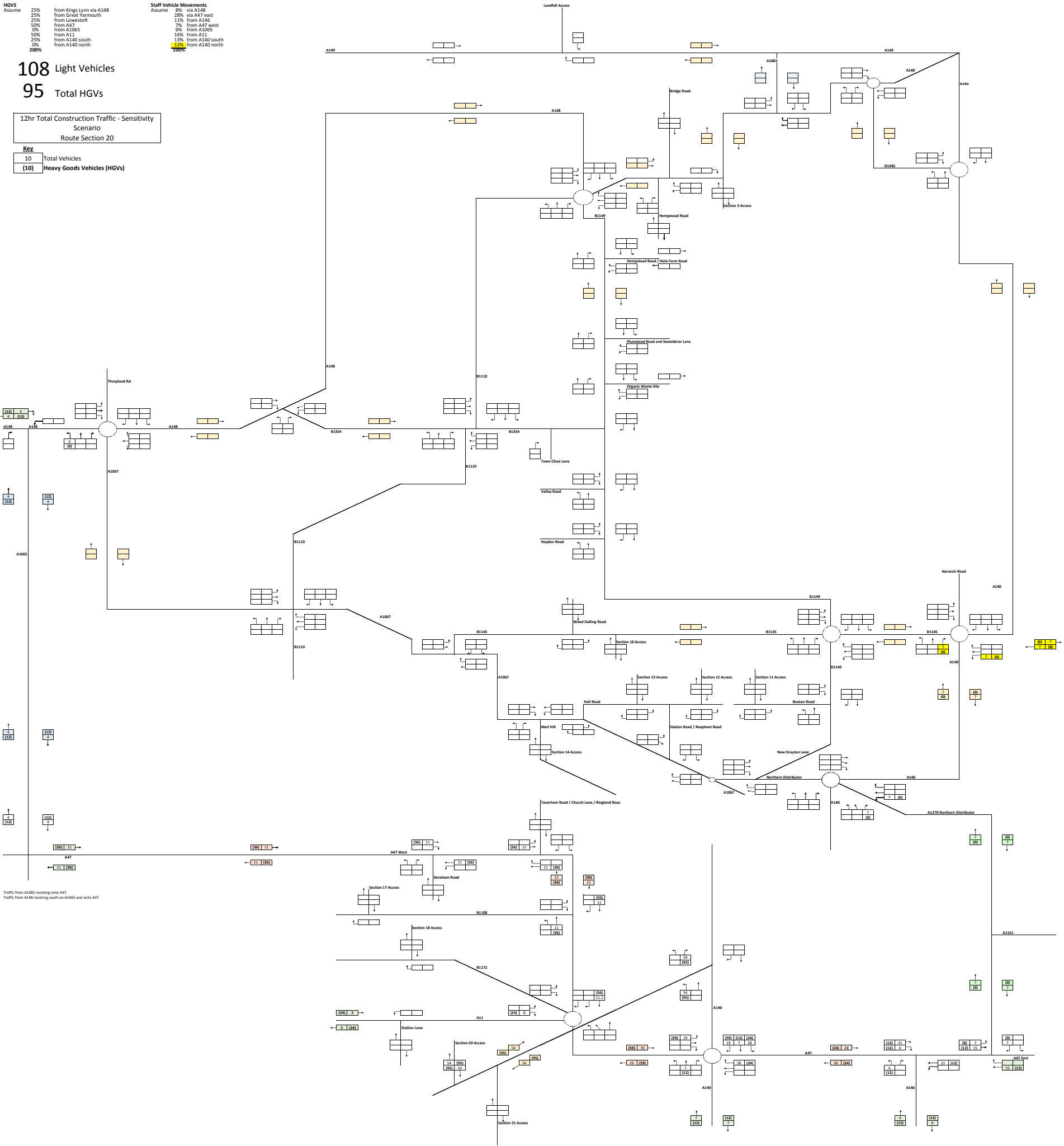

HGVS		Staff Vehicle Movements	
Assume	25%	Assume	28%
	25%		13%
	25%		7%
	0%		0%
	50%		10%
	25%		3%
	20%		12%
	200%		100%

128 Light Vehicles
140 Total HGVs

12hr Total Construction Traffic - Sensitivity Scenario
Route Section 21

Key	
10	Total Vehicles
(10)	Heavy Goods Vehicles (HGVs)

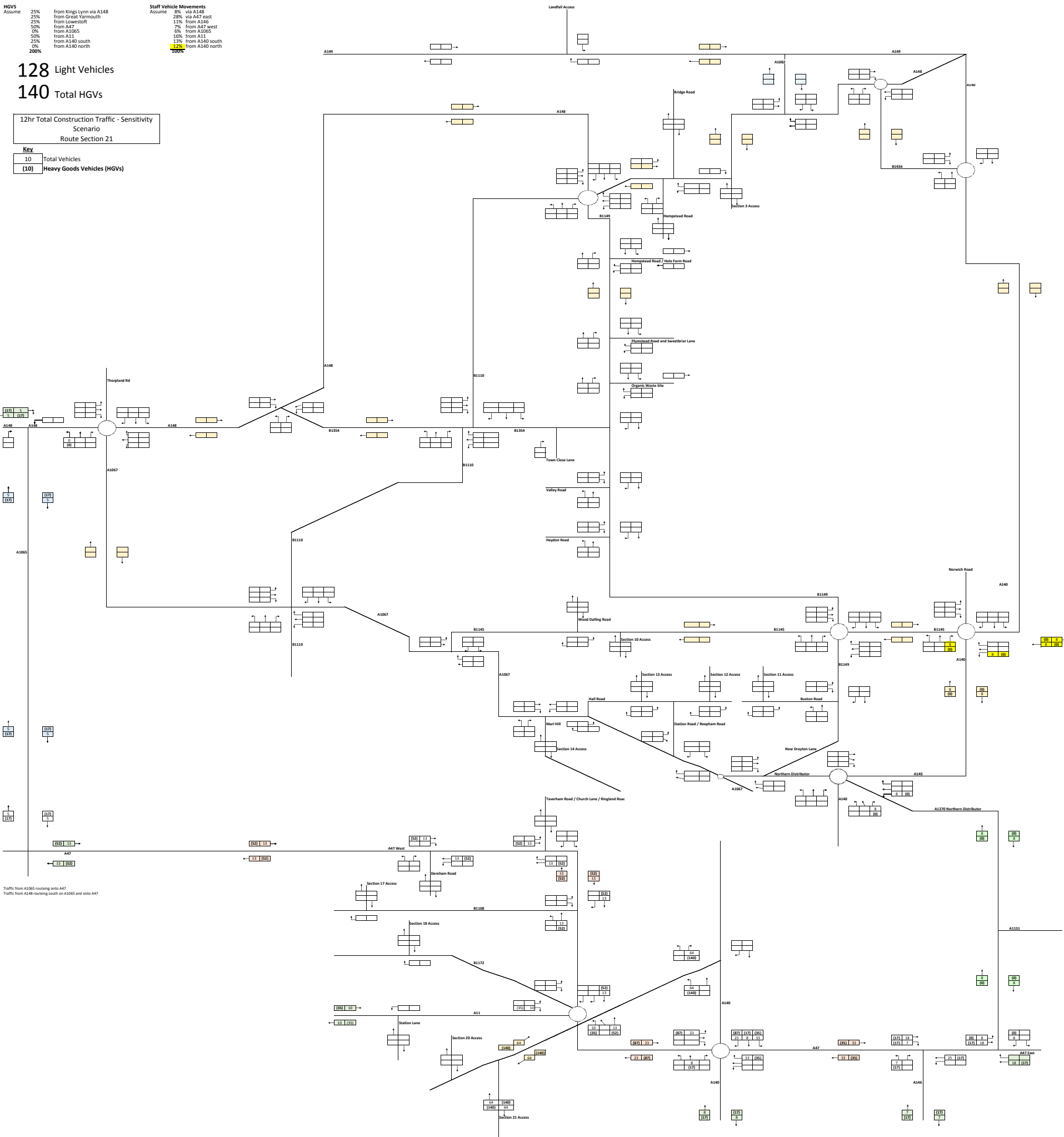

Traffic from A1050 reaching onto A47
Traffic from A148 reaching onto A1055 and onto A47

12hr Total Construction Traffic - Sensitivity Scenario Phase 4 Total

699 Light Vehicles

520 Total HGVs

Total Vehicles

Key
10 Total Vehicles
(10) Heavy Goods Vehicles (HGVs)

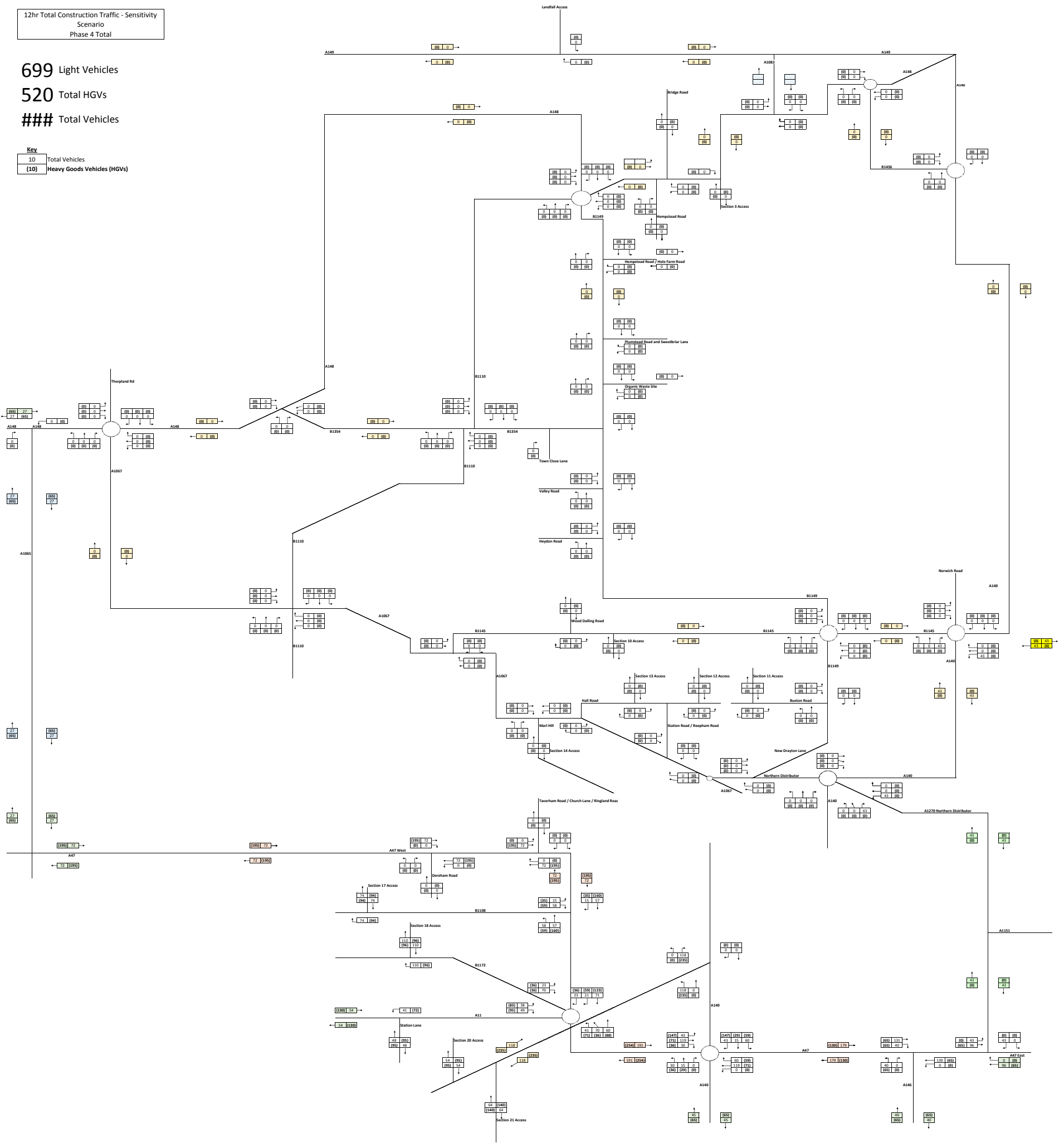

HGVs		
Assume	25%	from Kings Lynn via A148
	25%	from Great Yarmouth
	25%	from Lowestoft
	50%	from A47
	0%	from A1065
	50%	from A11
	25%	from A140 south
	0%	from A140 north
	200%	

Staff Vehicle Movements		
Assume	8%	via A148
	28%	via A47 east
	11%	from A146
	7%	from A47 west
	6%	from A1065
	16%	from A11
	13%	from A140 south
	12%	from A140 north
	100%	

10 Light Vehicles
5 Total HGVs

12hr Total Construction Traffic - Sensitivity Scenario Landfall

Key
10 Total Vehicles
10 Heavy Goods Vehicles (HGVs)

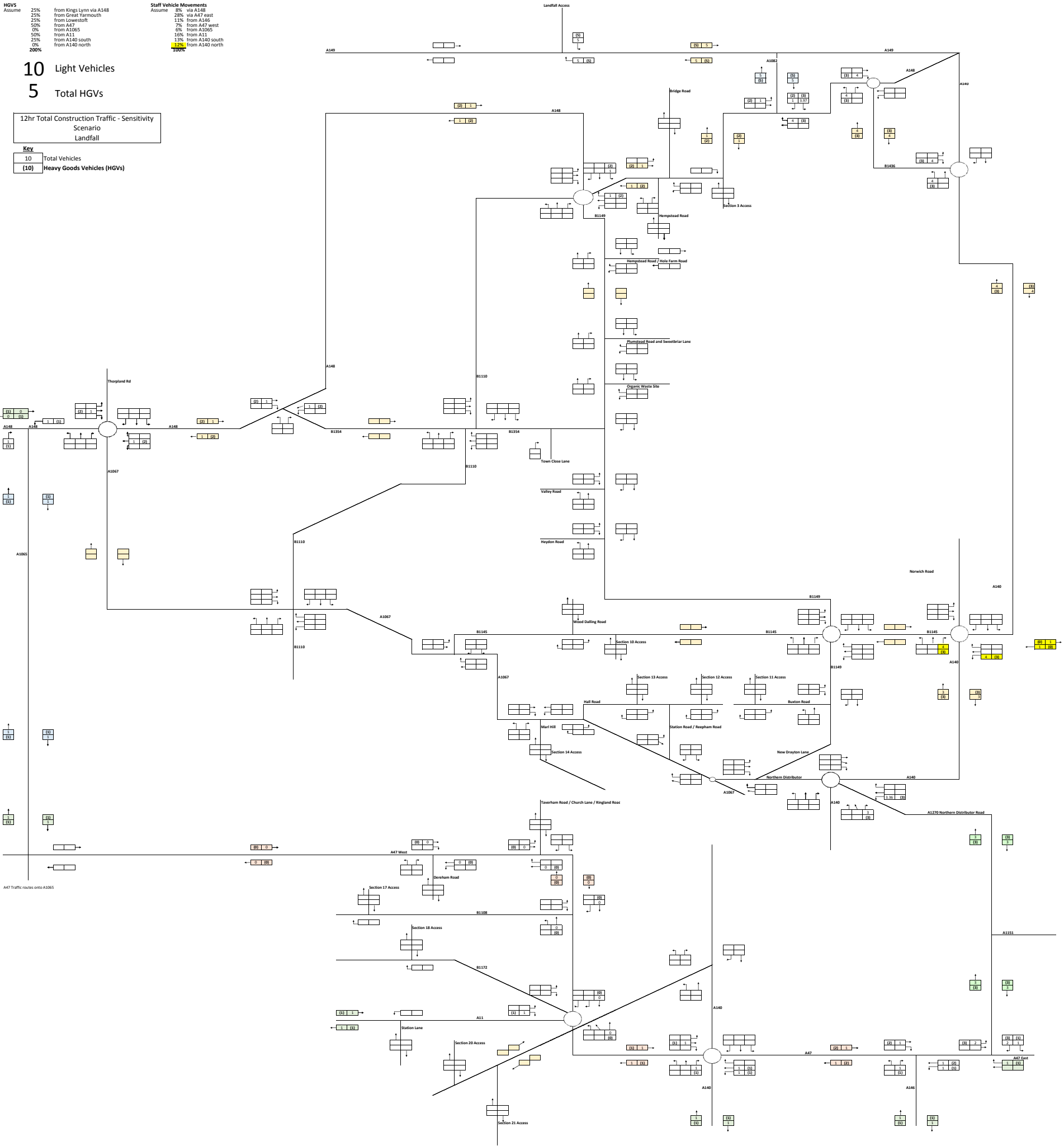

HGVs			
Assume	25%	from Kings Lynn via A148	
	25%	from Great Yarmouth	
	25%	from Lowestoft	
	50%	from A47	
	0%	from A1005	
	50%	from A11	
	25%	from A140 south	
	0%	from A140 north	
	200%		

Staff Vehicle Movements		
Assume	8%	via A148
	28%	via A47 east
	11%	from A146
	7%	from A47 west
	6%	from A1005
	16%	from A11
	13%	from A140 south
	12%	from A140 north
	100%	

34 Light Vehicles

12 Total HGVs

12hr Total Construction Traffic - Sensitivity Scenario
Booster Station

Key
10 Total Vehicles
(10) Heavy Goods Vehicles (HGVs)

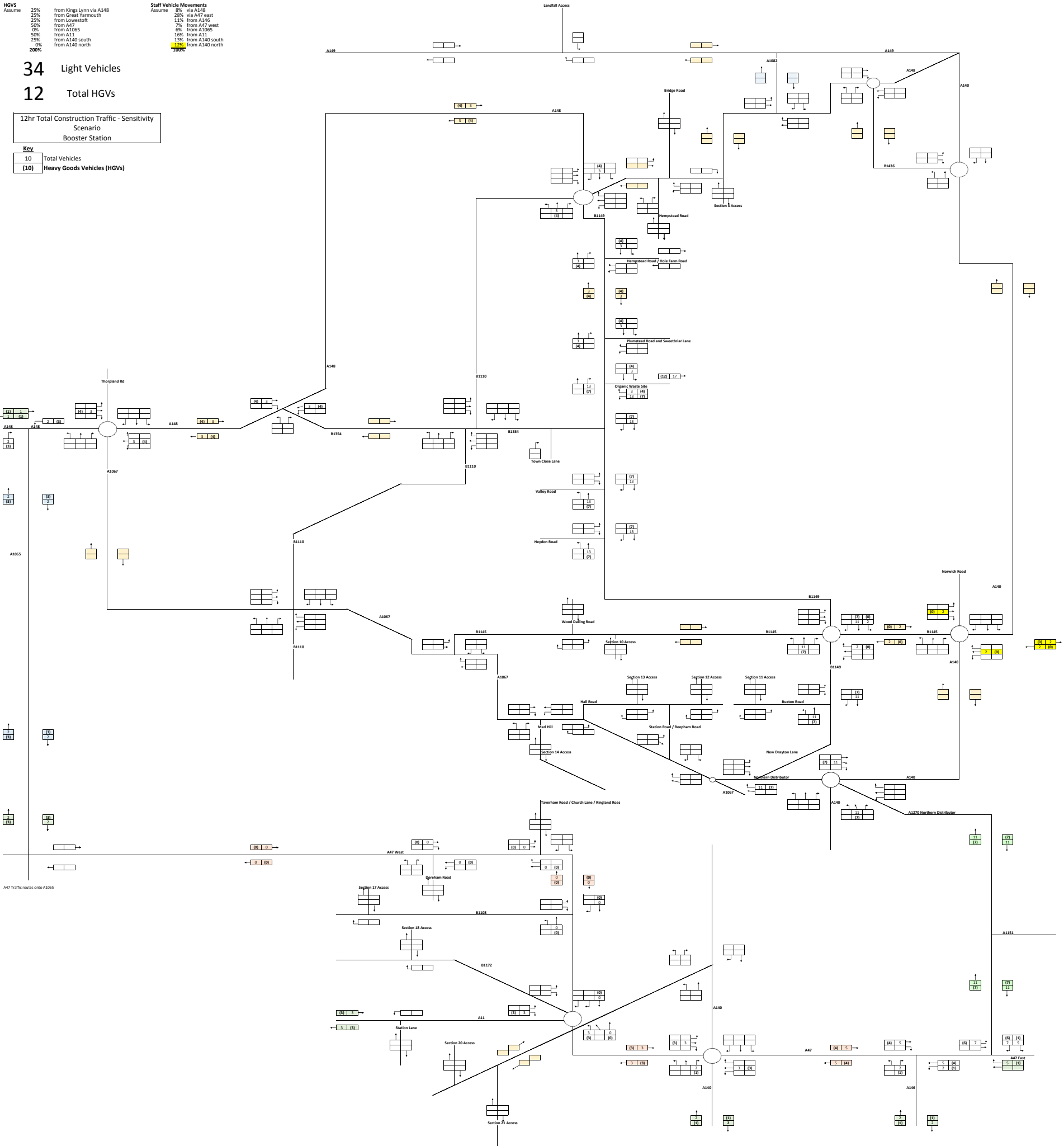

HGVs		Staff Vehicle Movements	
Assume	25%	Assume	30% via A148
	25%		28% via A47 east
	25%		11% from A146
	50%		7% from A47 west
	0%		6% from A105
	50%		16% from A11
	25%		13% from A140 south
	0%		12% from A140 north
	20%		10%

82 Light Vehicles
29 Total HGVs

12hr Total Construction Traffic - Sensitivity Scenario
HVAC Substation

Key
10 Total Vehicles
10 Heavy Goods Vehicles (HGVs)

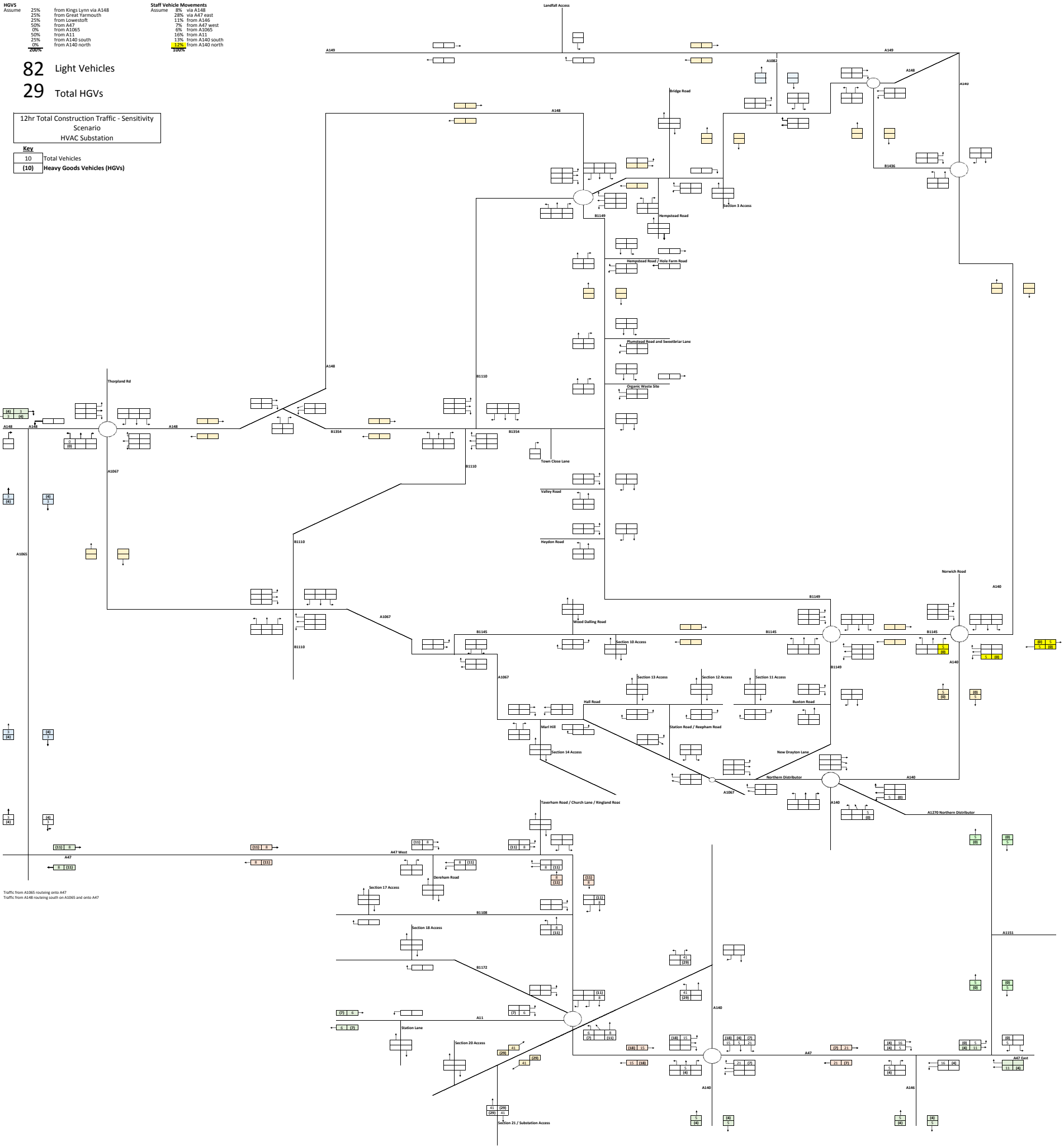

Traffic from A105 routing onto A47
Traffic from A148 routing south on A105 and onto A47

12hr Total Construction Traffic - Sensitivity Scenario
Maximum Construction Traffic

2,469 Light Vehicles
2,019 Total HGVs
4,488 Total Vehicles

Key
10 Total Vehicles
10 Heavy Goods Vehicles (HGVs)

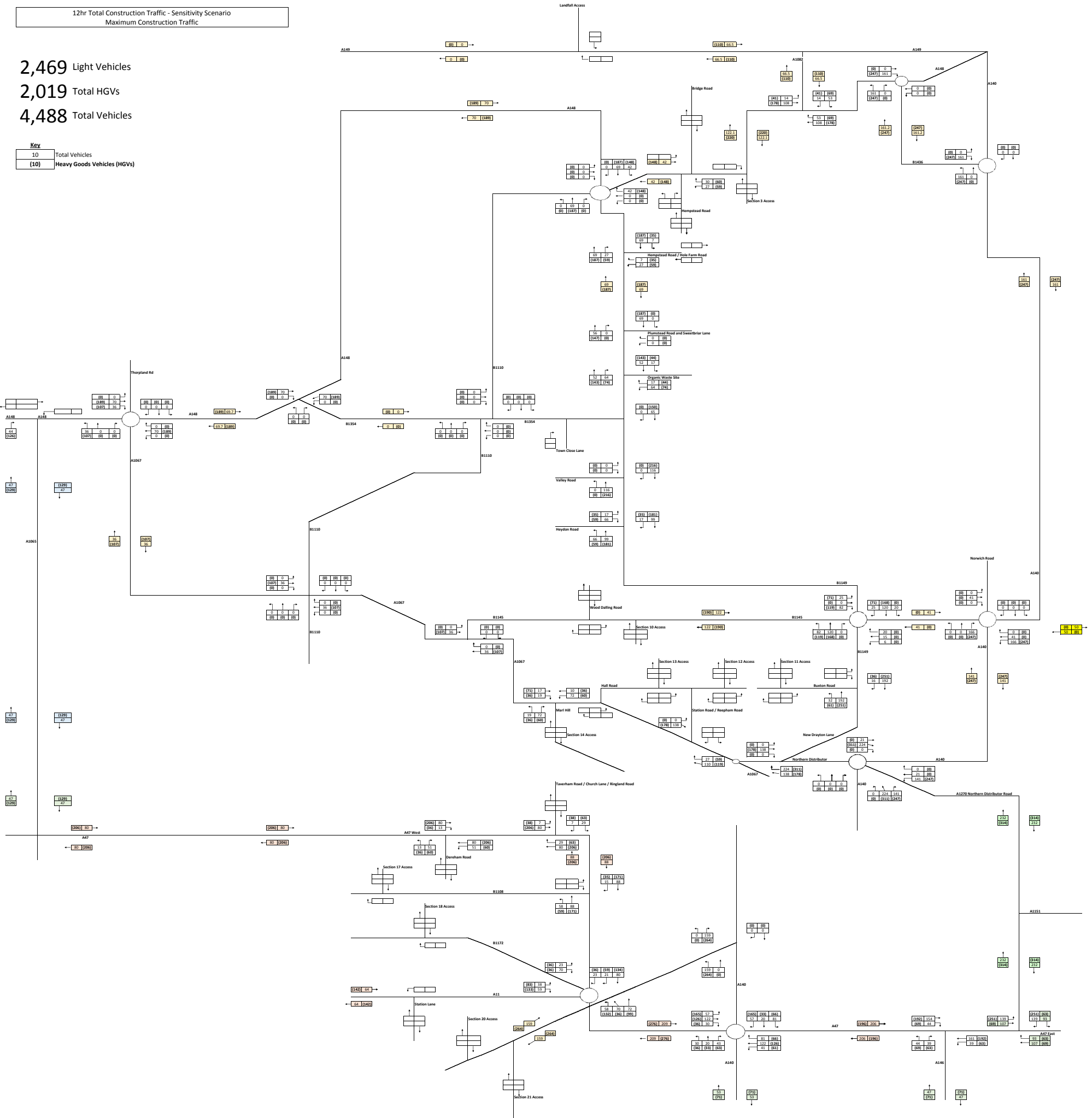

12hr Total Construction Traffic - Sensitivity Scenario
Total Construction Traffic

2,469 Light Vehicles
2,019 Total HGVs
4,488 Total Vehicles

Key
10 Total Vehicles
(10) Heavy Goods Vehicles (HGVs)

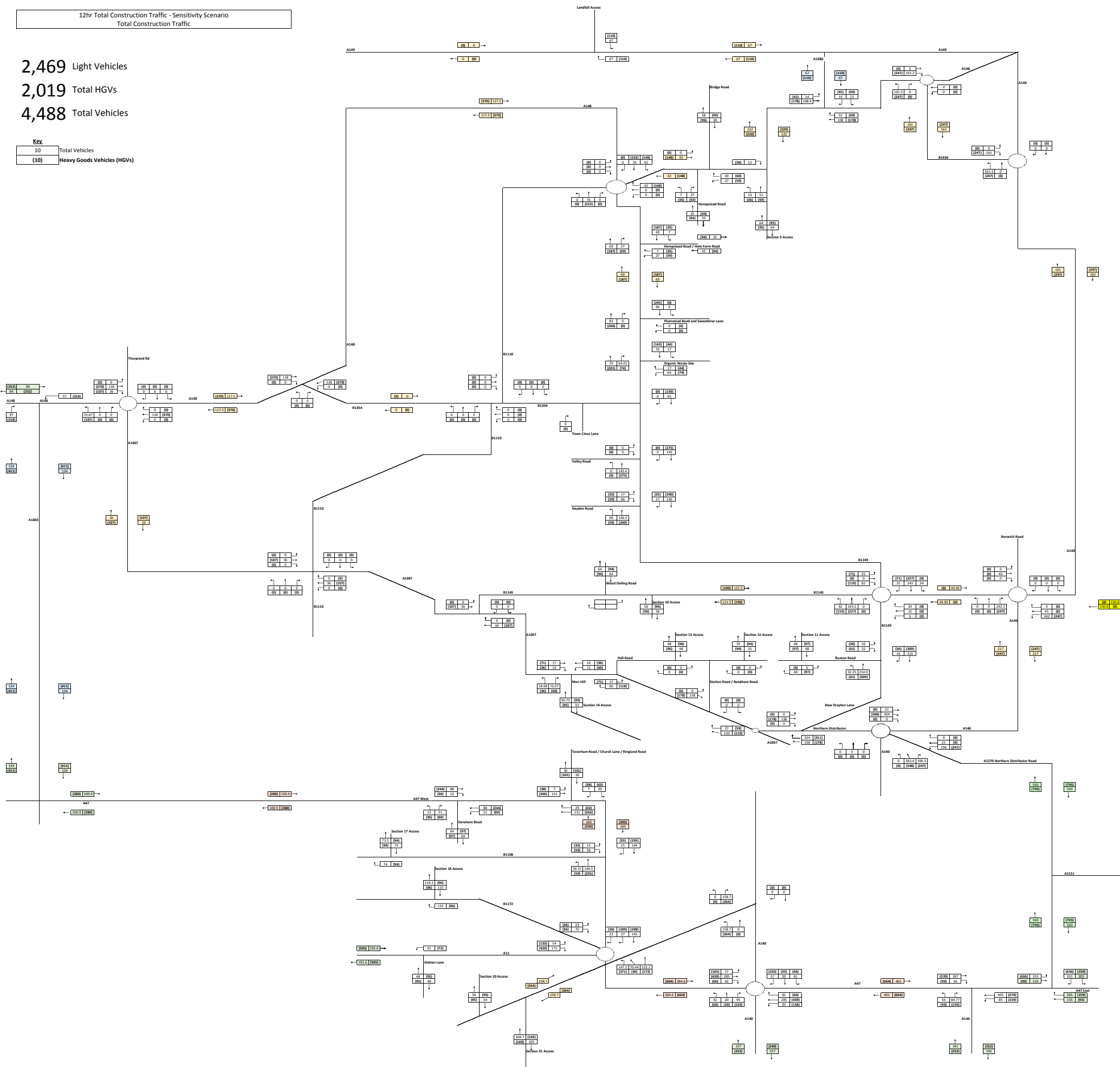

Traffic Flow Diagrams

Construction Staff Traffic Flows
AM (07:00-08:00)

2017 Observed Traffic Flows

07:00-08:00

Key

10	Total Vehicles
(10)	Heavy Goods Vehicles (HGVs)

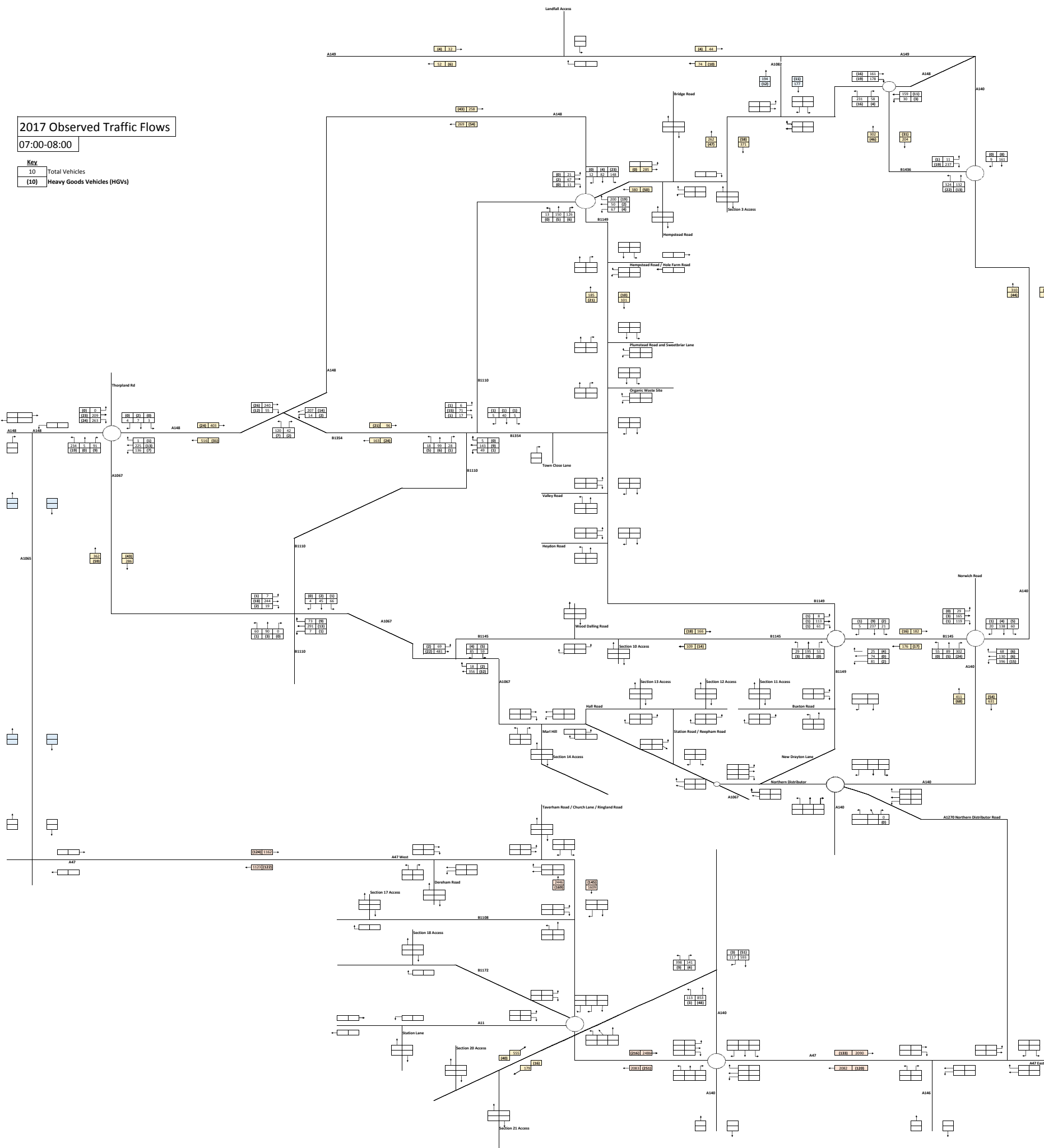

TEMPRO	
Average Weekday	
Thurs	1.30 growth 2017-2022
Principal	1.00 growth 2017-2022
Minor	1.00 growth 2017-2022

2022 Base Traffic Flows

07:00-08:00

Key	
10	Total Vehicles
10	Heavy Goods Vehicles (HGVs)

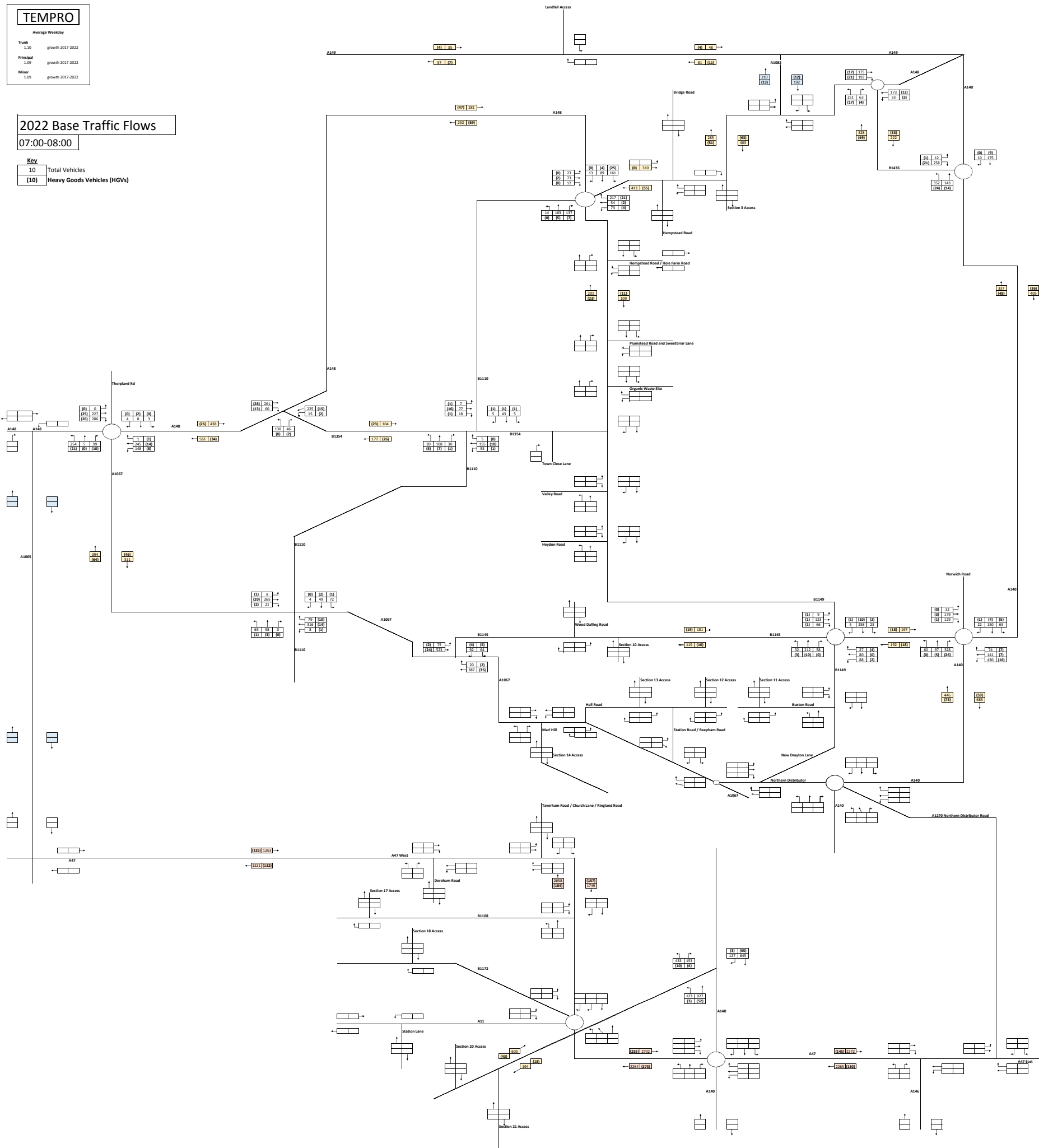

Tables Linked to Construction Vehicle Movements Spreadsheet

Route Section	Description	Staff Peak Hour Vehicle Flows			
		Total	HGV	Lights	Phase
1	Landfall to Holgate Hill	68	0	68	1
2	Holgate Hill to woodland north east of High Kelling	38	0	38	1
3	Woodland northeast of High Kelling to woodland south of Church Road	58	0	58	1
4	Woodland south of Church Road to woodland south and east of School Lane	35	0	35	1
5	Woodland east of School Lane to Plumstead Road	35	0	35	1
6	Plumstead Road to the B1149	64	0	64	2
7	B1149 to land South of Town Close Lane	38	0	38	-
8	Land south of Town Close Lane to woodland north of Reepham Road	83	0	83	2
9	Land north of Reepham Road to woodland north of Reepham	64	0	64	2
10	Woodland north of Reepham to woodland at Booton Common	58	0	58	2
11	Woodland east of Reepham to The Grove	48	0	48	2
12	The Grove to woodland south of Church Farm Lane	35	0	35	3
13	Woodland south of Church Farm Lane to River Wensum	48	0	48	3
14	River Wensum to woodland south west of Ringland	97	0	97	3
15	Woodland south west of Ringland to A47	42	0	42	3
16	A47 to Bawburgh Road	64	0	64	3
17	Bawburgh Road to woodland west of Little Melton	68	0	68	4
18	Woodland west of Little Melton to A11	116	0	116	4
19	A11 to woodland north west of Swardeston	54	0	54	4
20	Woodland north west of Swardeston to B1113	54	0	54	4
21	B1113 to end of cable route	64	0	64	4
Landfall	Landfall	5	0	5	
Booster Station	Booster Station	17	0	17	
Converter / Sub Station	Converter / Sub Station	41	0	41	
Total:		1,294	0	1,294	1,294

HGVs Assume	25%	from Kings Lynn via A148	Staff Vehicle Movements Assume	8%	via A148
	25%	from Great Yarmouth		28%	via A47 east
	25%	from Lowestoft		11%	from A146
	50%	from A47		7%	from A47 west
	0%	from A1065		6%	from A1065
	50%	from A11		16%	from A11
25%	from A140 south	13%	from A140 south		
25%	from A140 north	12%	from A140 north		
25%		10%			

68 Light Vehicles
0 Total HGVs

AM Construction Staff Traffic Flows
 Route Section 1

Key
10 Light Vehicles
(10) Heavy Goods Vehicles (HGVs)

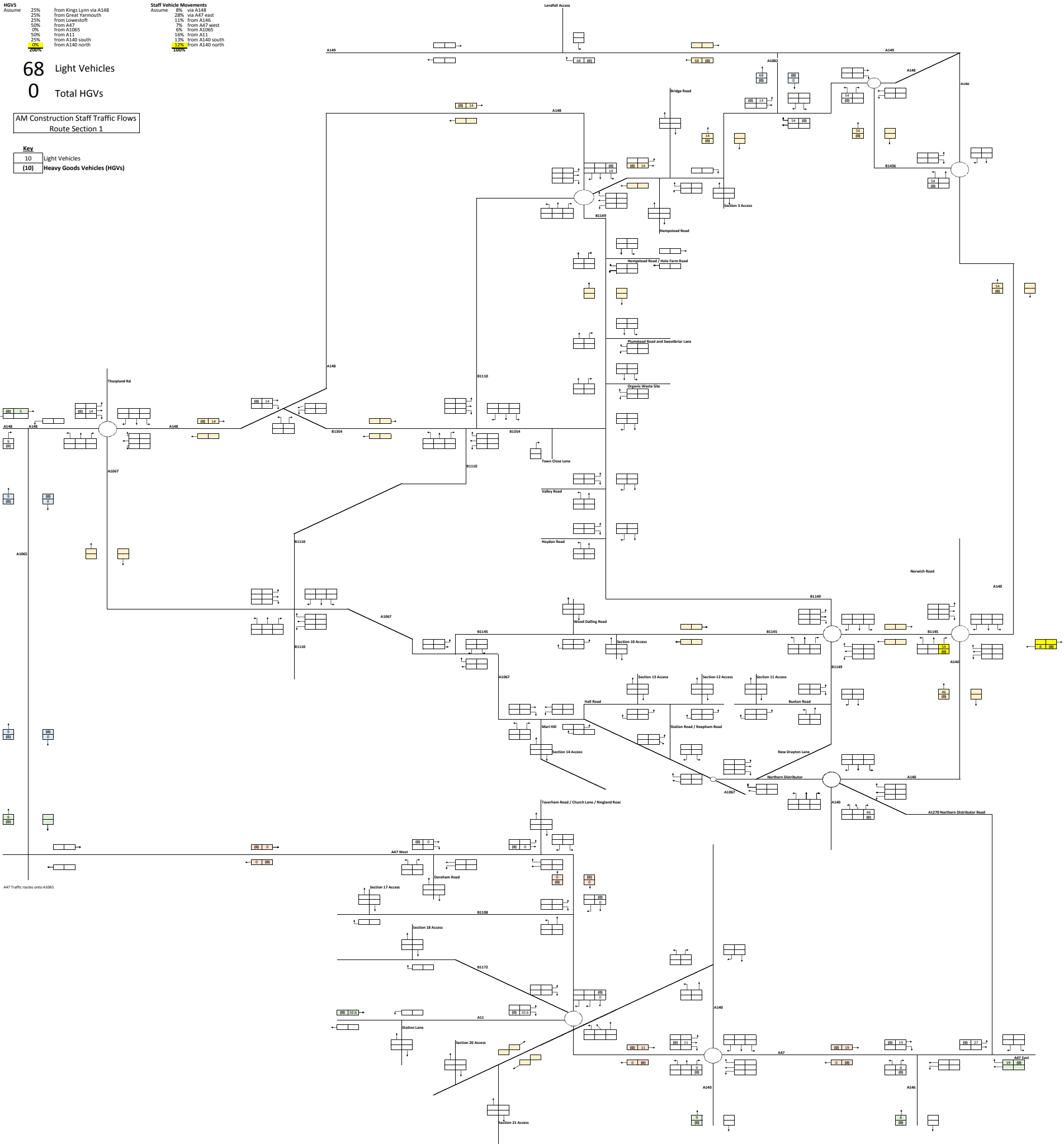

HGVs		
Assume	25%	from Kings Lynn via A148
	25%	from Great Yarmouth
	25%	from Lowestoft
	50%	from A47
	0%	from A1065
	50%	from A11
	25%	from A140 south
	25%	from A140 north
	25%	from A140 north
	25%	from A140 north

Staff Vehicle Movements		
Assume	8%	via A148
	28%	via A47 east
	11%	from A148
	7%	from A47 west
	6%	from A1065
	16%	from A11
	13%	from A140 south
	12%	from A140 north
	10%	from A140 north

38 Light Vehicles
0 Total HGVs

AM Construction Staff Traffic Flows
Route Section 2

Key	
10	Light Vehicles
10	Heavy Goods Vehicles (HGVs)

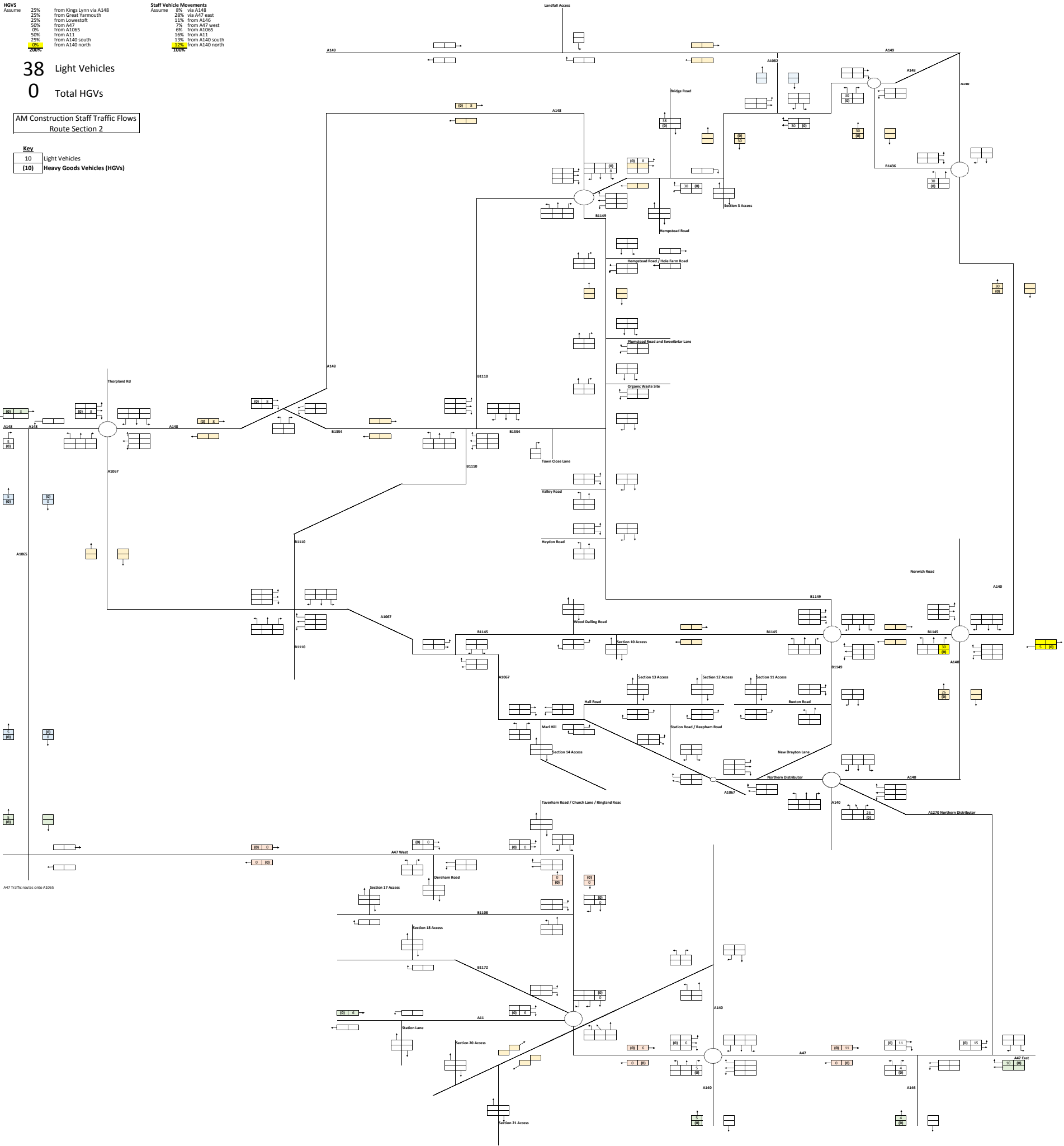

HGVs

Assume	25%	from Kings Lynn via A148
	25%	from Great Yarmouth
	25%	from Lowestoft
	50%	from A47
	0%	from A1065
	50%	from A11
	25%	from A140 south
	25%	from A140 north
	25%	from A140 north

Staff Vehicle Movements

Assume	8%	via A148
	28%	via A47 east
	11%	from A146
	7%	from A47 west
	6%	from A1065
	16%	from A11
	13%	from A140 south
	12%	from A140 north
	10%	from A140 north

58 Light Vehicles
0 Total HGVs

AM Construction Staff Traffic Flows
Route Section 3

Key
10 Light Vehicles
10 Heavy Goods Vehicles (HGVs)

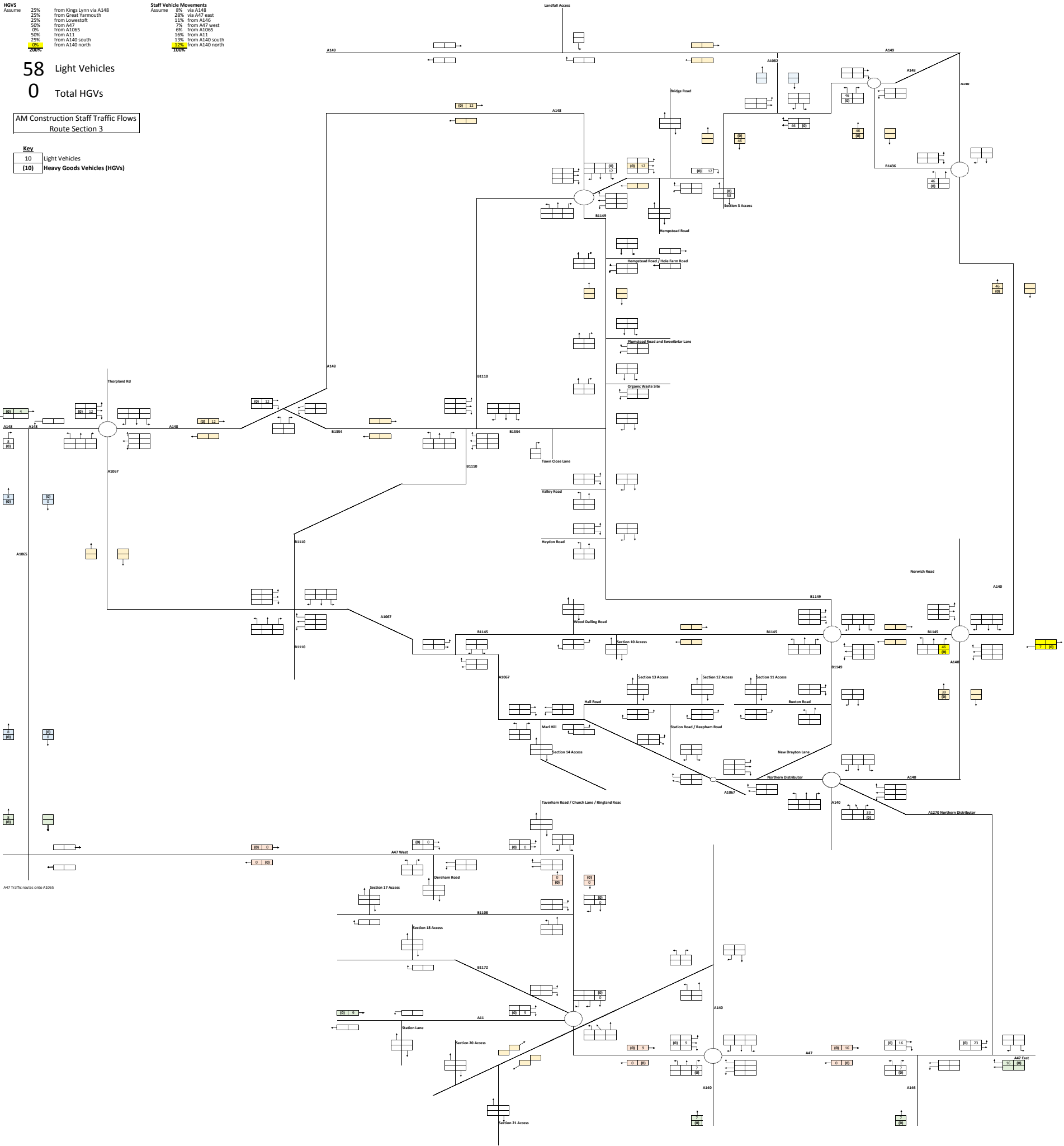

HGVs	Assume	25%	from Kings Lynn via A148
	Assume	25%	from Great Yarmouth
	Assume	25%	from Lowestoft
	Assume	50%	from A47
	Assume	0%	from A1065
	Assume	50%	from A11
	Assume	25%	from A140 south
	Assume	25%	from A140 north
	Assume	25%	from A140 north

Staff Vehicle Movements	Assume	8%	via A148
	Assume	28%	via A47 east
	Assume	11%	from A146
	Assume	7%	from A47 west
	Assume	6%	from A1065
	Assume	16%	from A11
	Assume	13%	from A140 south
	Assume	12%	from A140 north
	Assume	10%	from A140 north

35 Light Vehicles
0 Total HGVs

AM Construction Staff Traffic Flows
Route Section 4

Key
10 Light Vehicles
(10) Heavy Goods Vehicles (HGVs)

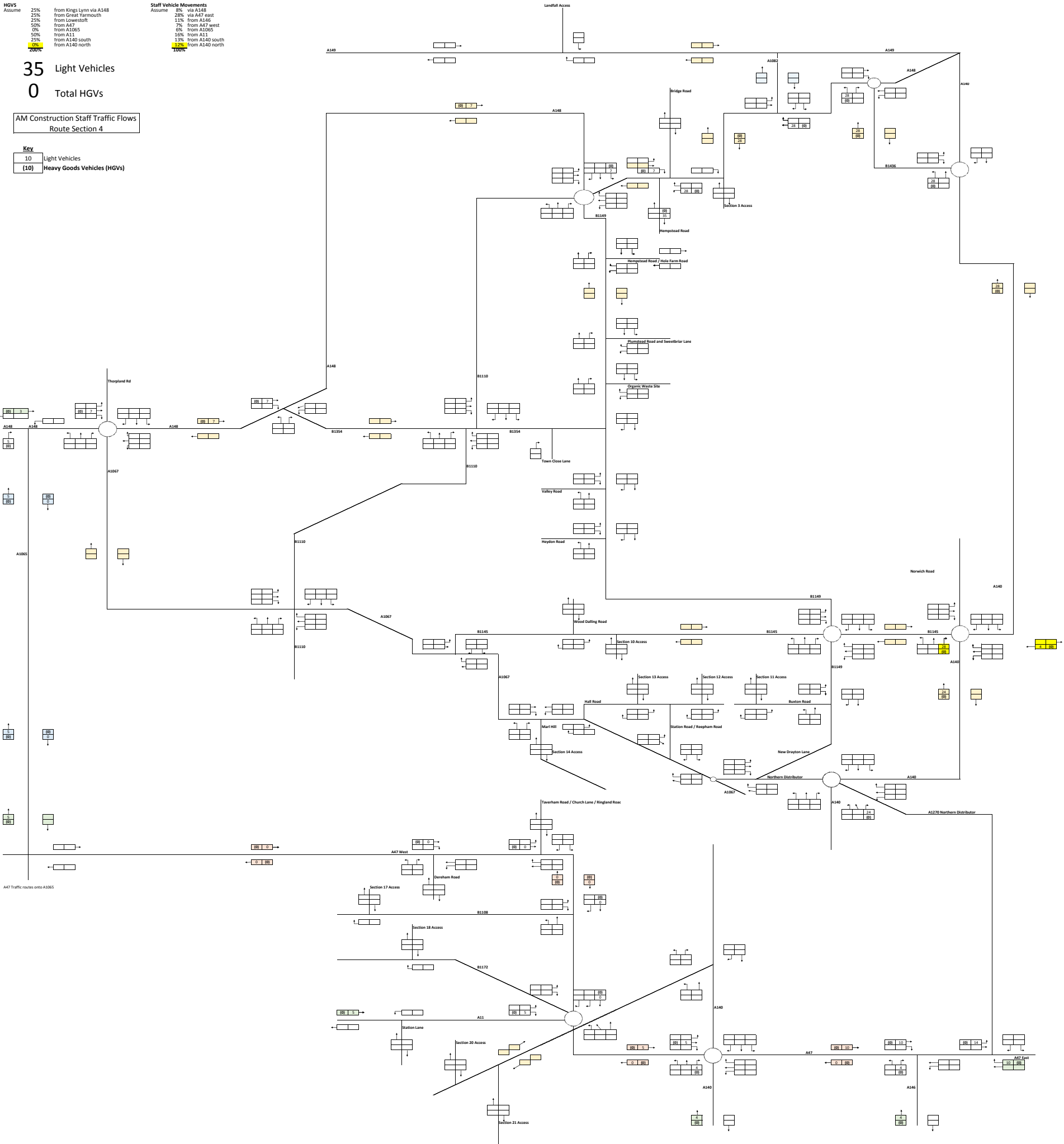

HGVs		Staff Vehicle Movements	
Assume	25%	Assume	25%
	from Kings Lynn via A148		via A148
	25%		28%
	from Great Yarmouth		via A47 east
	25%		11%
	from Lowestoft		11%
	50%		7%
	from A47		6%
	0%		16%
	from A1065		1%
	50%		1%
	from A11		12%
	25%		12%
	from A140 south		12%
	25%		12%
	from A140 north		12%

35 Light Vehicles

0 Total HGVs

AM Construction Staff Traffic Flows
Route Section 5

Key	
10	Light Vehicles
(10)	Heavy Goods Vehicles (HGVs)

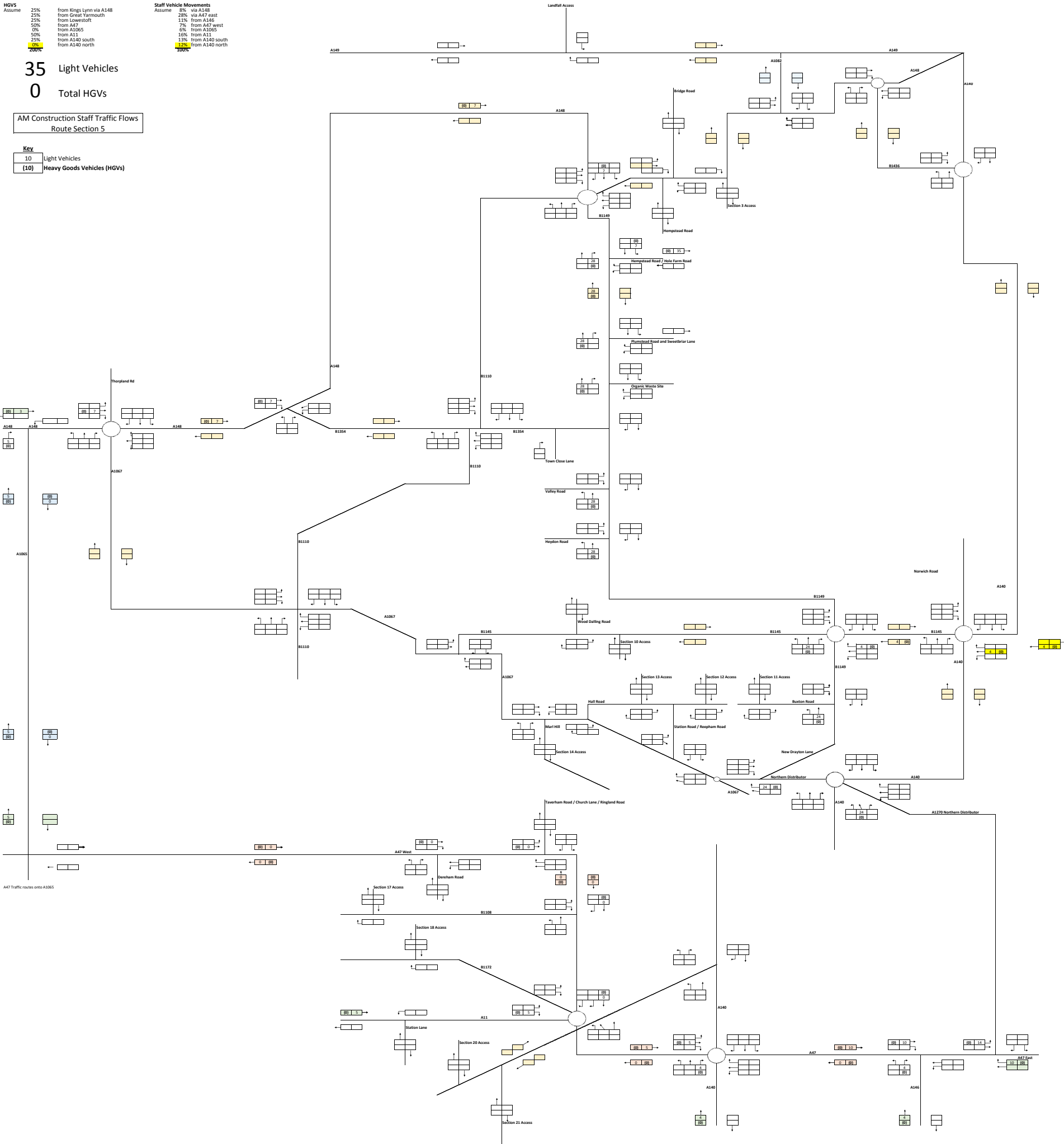

AM Construction Staff Traffic Flows
Phase 1 Total

234 Light Vehicles

0 Total HGVs

234 Total Vehicles

Key
 10 Light Vehicles
 (10) Heavy Goods Vehicles (HGVs)

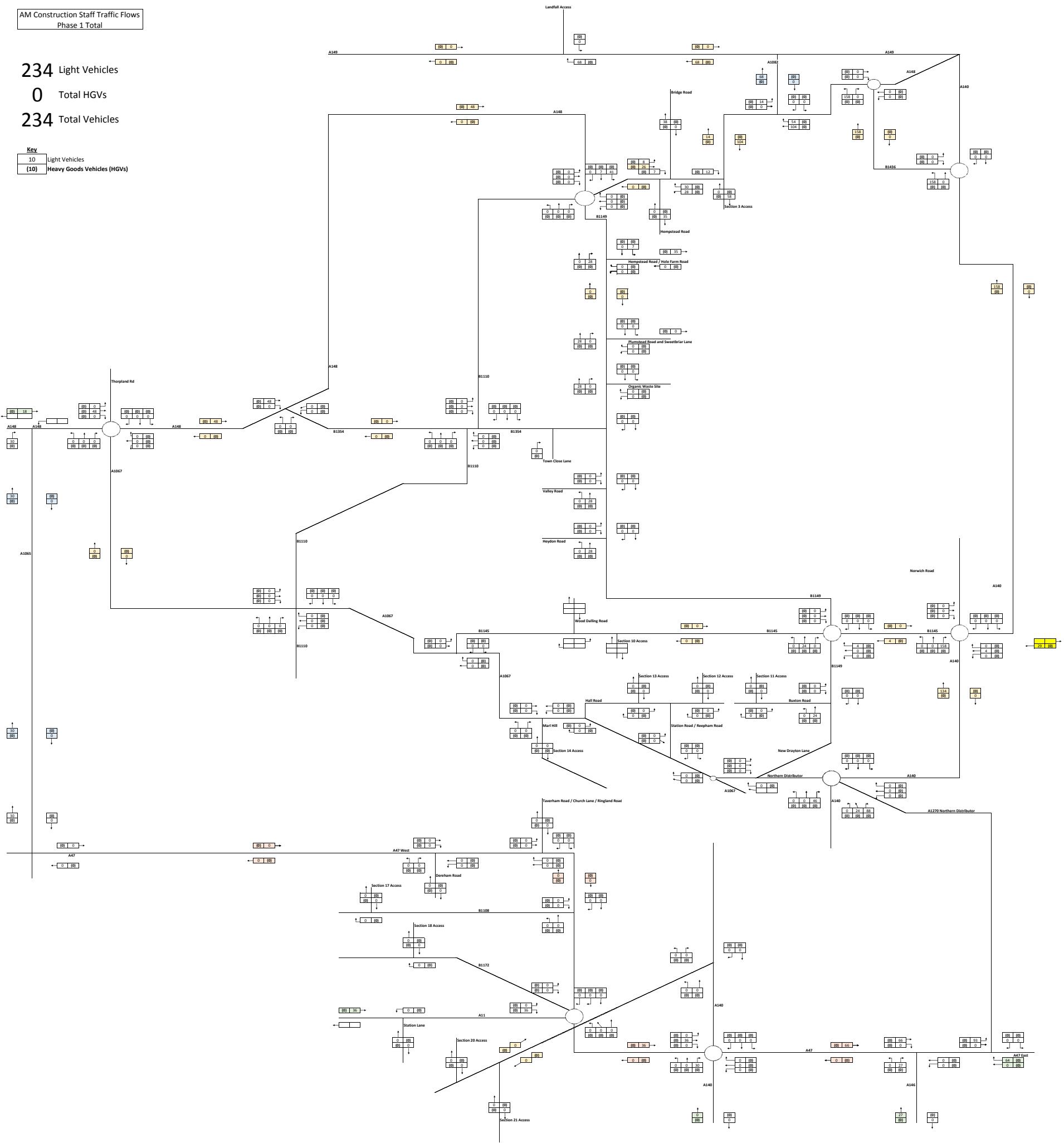

HGVS		Staff Vehicle Movements	
Assume		Assume	
25%	from Kings Lynn via A148	8%	via A148
25%	from Great Yarmouth	28%	via A47 east
25%	from Lowestoft	11%	from A146
50%	from A47	7%	from A47 west
0%	from A1065	6%	from A1065
50%	from A11	16%	from A11
25%	from A140 south	13%	from A140 south
25%	from A140 north	12%	from A140 north
25%		10%	

64 Light Vehicles
0 Total HGVs

AM Construction Staff Traffic Flows
Route Section 6

Key	
10	Light Vehicles
(10)	Heavy Goods Vehicles (HGVs)

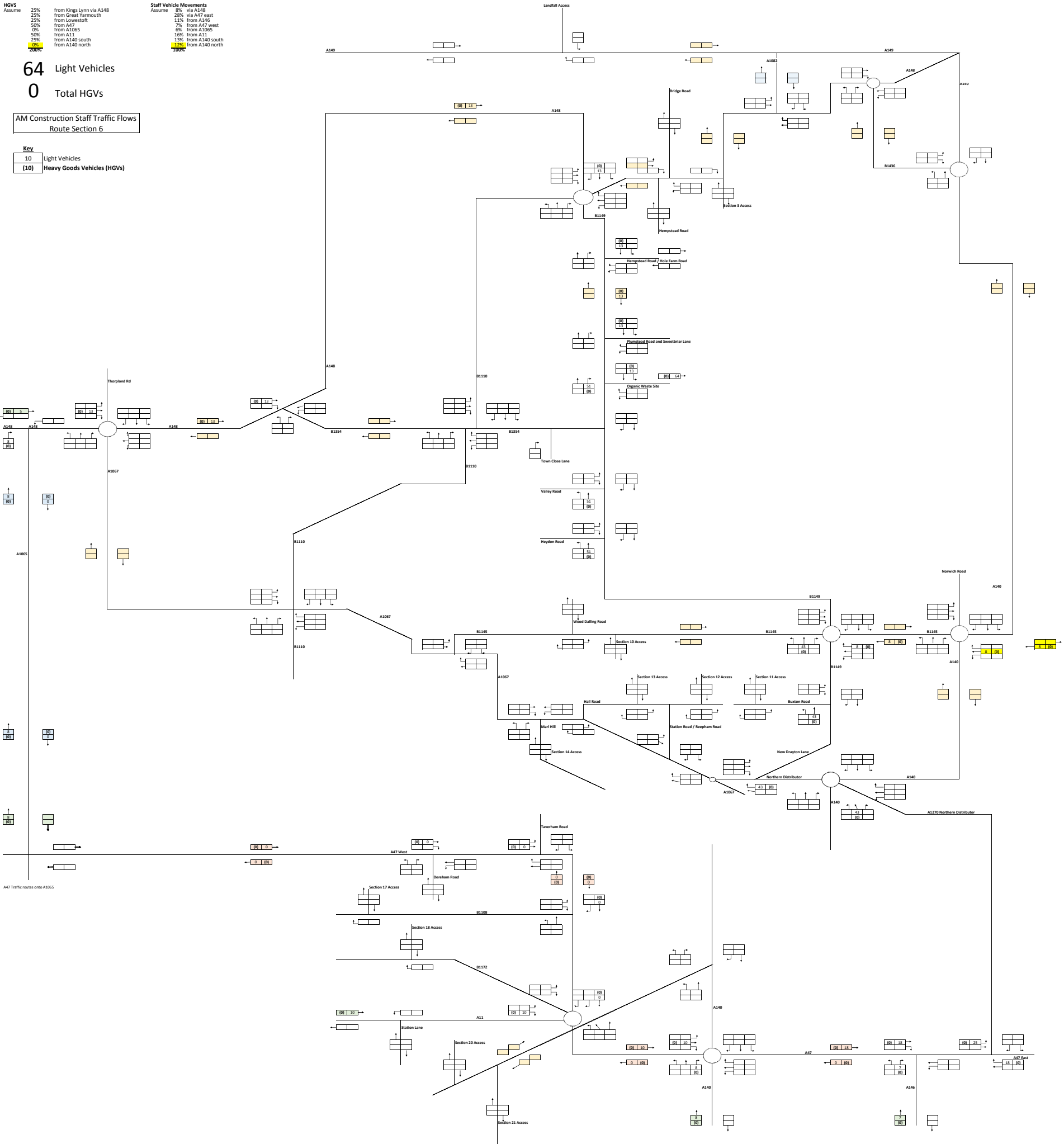

HGVs		
Assume	25%	from Kings Lynn via A148
	25%	from Great Yarmouth
	25%	from Lowestoft
	50%	from A47
	0%	from A1065
	50%	from A11
	25%	from A140 south
	25%	from A140 north
	25%	from A140 north
	25%	from A140 north

Staff Vehicle Movements		
Assume	8%	via A148
	28%	via A47 east
	11%	from A146
	7%	from A47 west
	6%	from A1065
	16%	from A11
	13%	from A140 south
	12%	from A140 north
	12%	from A140 north

83 Light Vehicles

0 Total HGVs

AM Construction Staff Traffic Flows
Route Section 8

Key	
10	Light Vehicles
(10)	Heavy Goods Vehicles (HGVs)

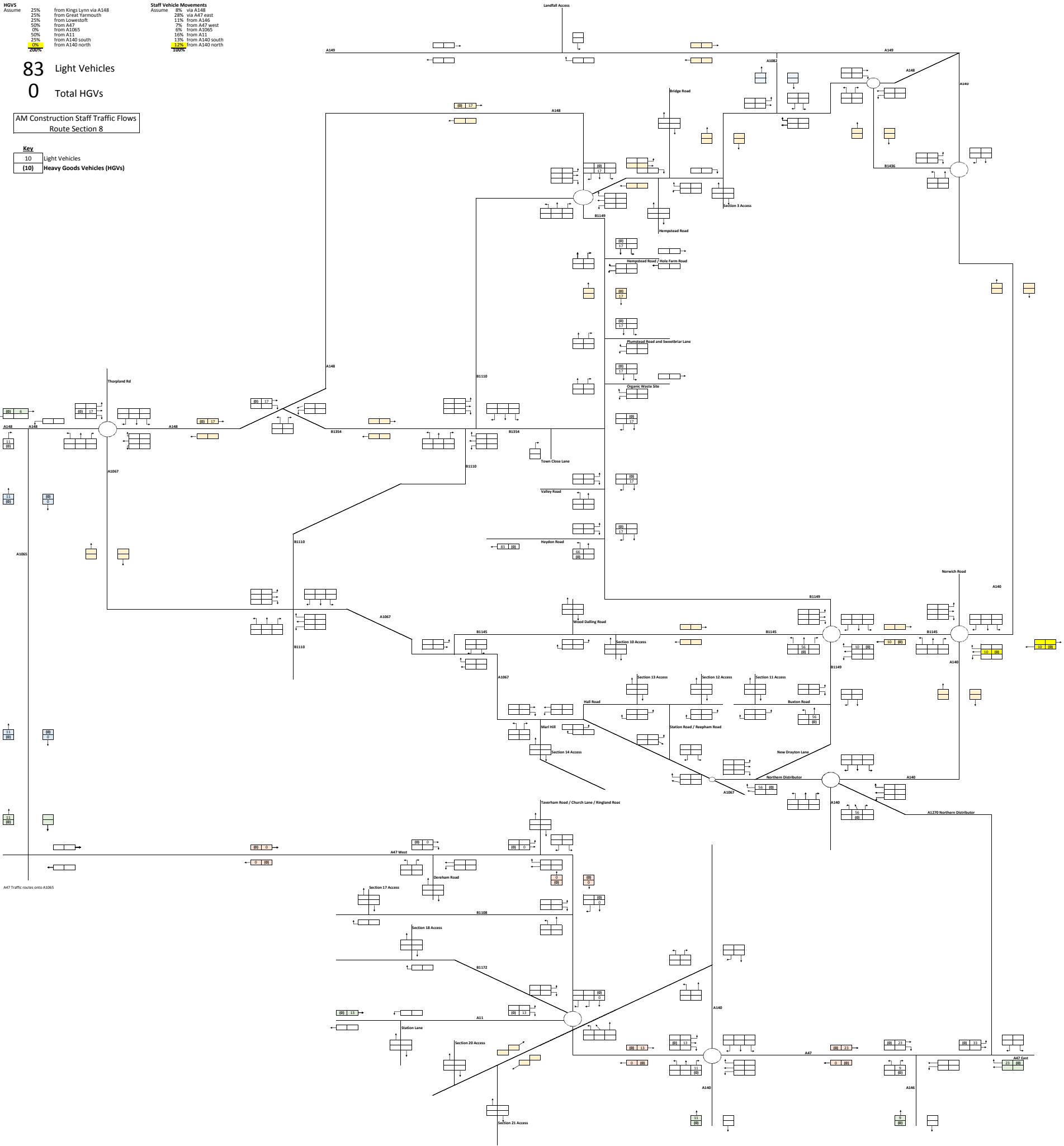

HGVs	Staff Vehicle Movements
Assume 25% from Kings Lynn via A148	Assume 82% via A148
25% from Great Yarmouth	28% via A47 east
25% from Lowestoft	11% from A146
50% from A47	7% from A47 west
0% from A1065	8% from A1065
50% from A11	16% from A11
25% from A140 south	13% from A140 south
25% from A140 north	13% from A140 north
25%	100%

64 Light Vehicles
0 Total HGVs

AM Construction Staff Traffic Flows
Route Section 9

Key
10 Light Vehicles
(10) Heavy Goods Vehicles (HGVs)

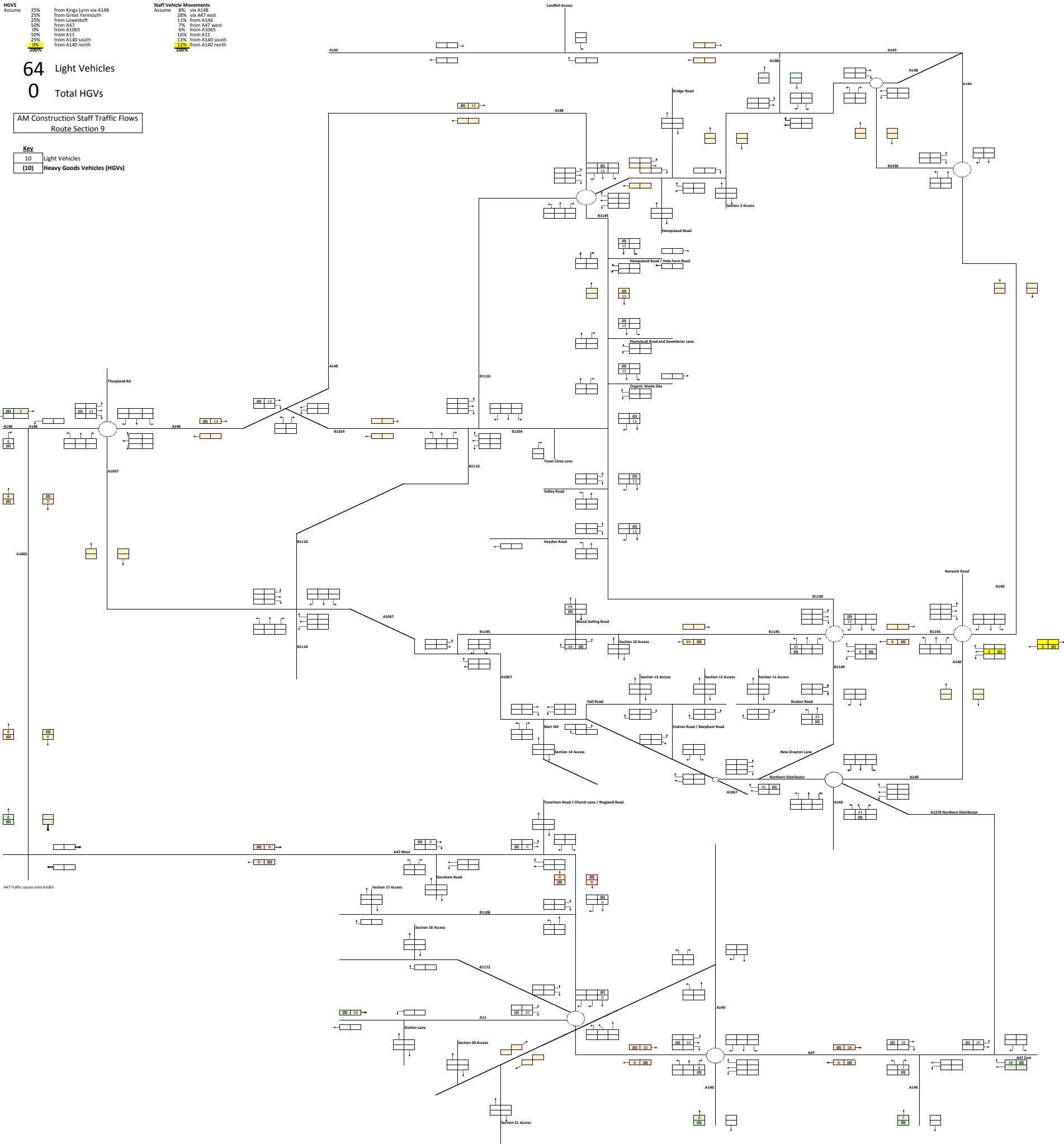

HGVs	25%	from Kings Lynn via A148	Staff Vehicle Movements	28%	via A148
Assume	25%	from Great Yarmouth	Assume	13%	from A146
	25%	from A147		7%	from A147 west
	50%	from A1065		6%	from A1065
	0%	from A11		10%	from A11
	25%	from A140 south		13%	from A140 south
	0%	from A140 north		12%	from A140 north
	25%			10%	

58 Light Vehicles
0 Total HGVs

AM Construction Staff Traffic Flows
 Route Section 10

Key	
10	Light Vehicles
(10)	Heavy Goods Vehicles (HGVs)

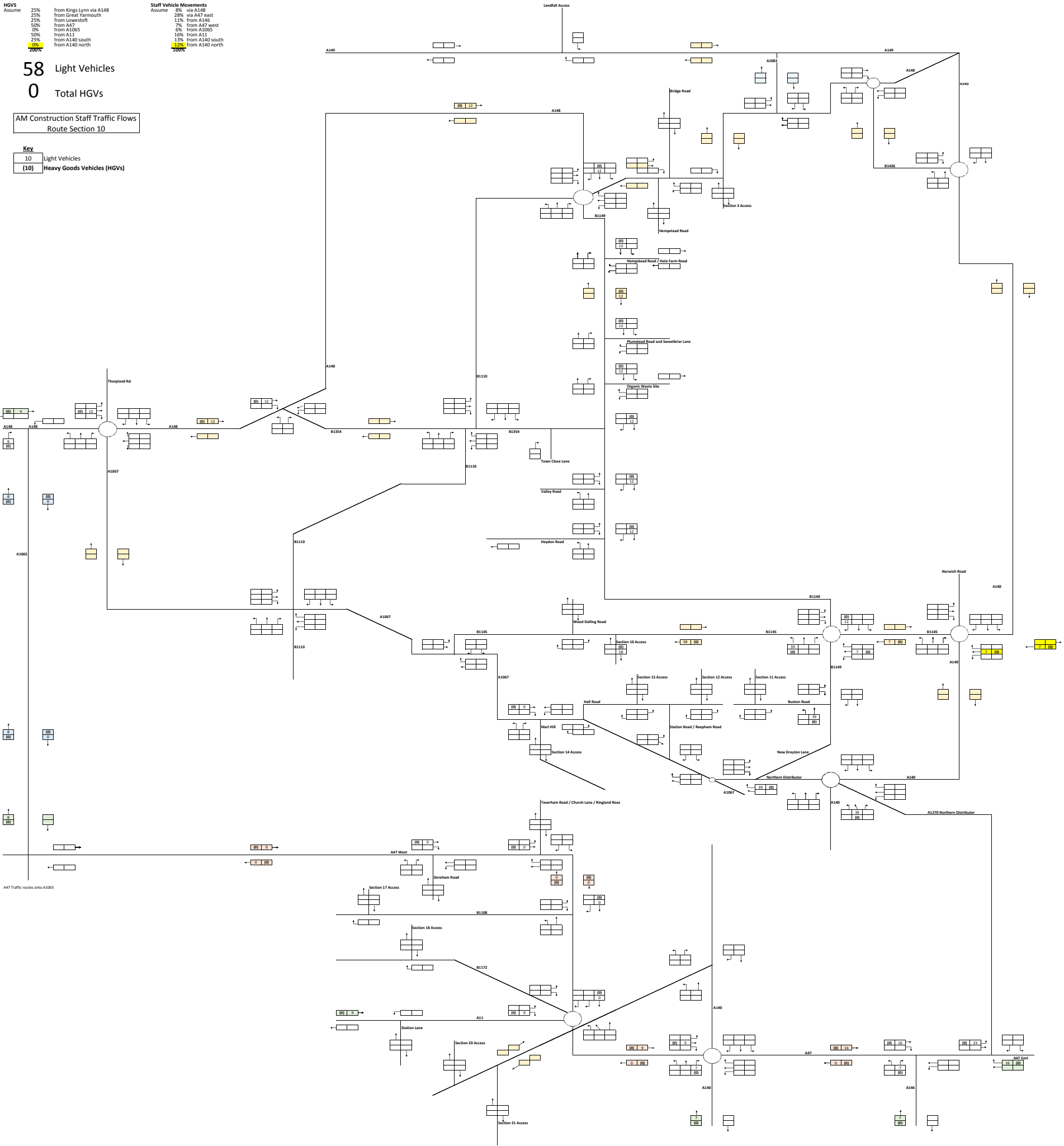

HGVs	25%	from Kings Lynn via A148	Staff Vehicle Movements	25%	via A148
Assume	25%	from Great Yarmouth	Assume	28%	via A47 east
	25%	from Lowestoft		11%	from A146
	50%	from A47		7%	from A47 west
	0%	from A1065		6%	from A1065
	50%	from A11		10%	from A11
	25%	from A140 south		13%	from A140 south
	25%	from A140 north		12%	from A140 north
	25%			12%	

48 Light Vehicles

0 Total HGVs

AM Construction Staff Traffic Flows
Route Section 11

Key	
10	Light Vehicles
(10)	Heavy Goods Vehicles (HGVs)

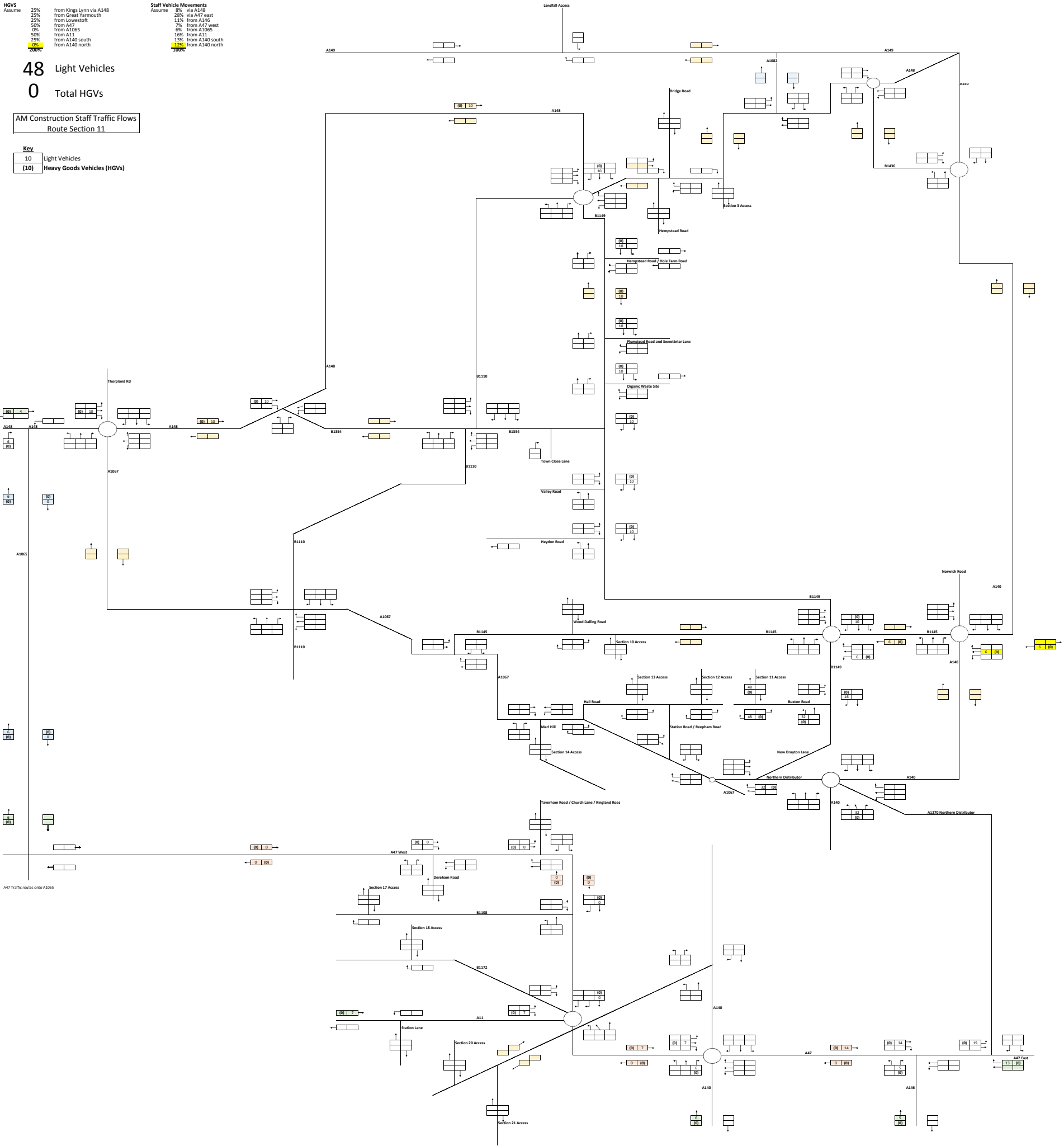

AM Construction Staff Traffic Flows
Phase 2 Total

317 Light Vehicles

0 Total HGVs

317 Total Vehicles

Key	
10	Light Vehicles
10	Heavy Goods Vehicles (HGVs)

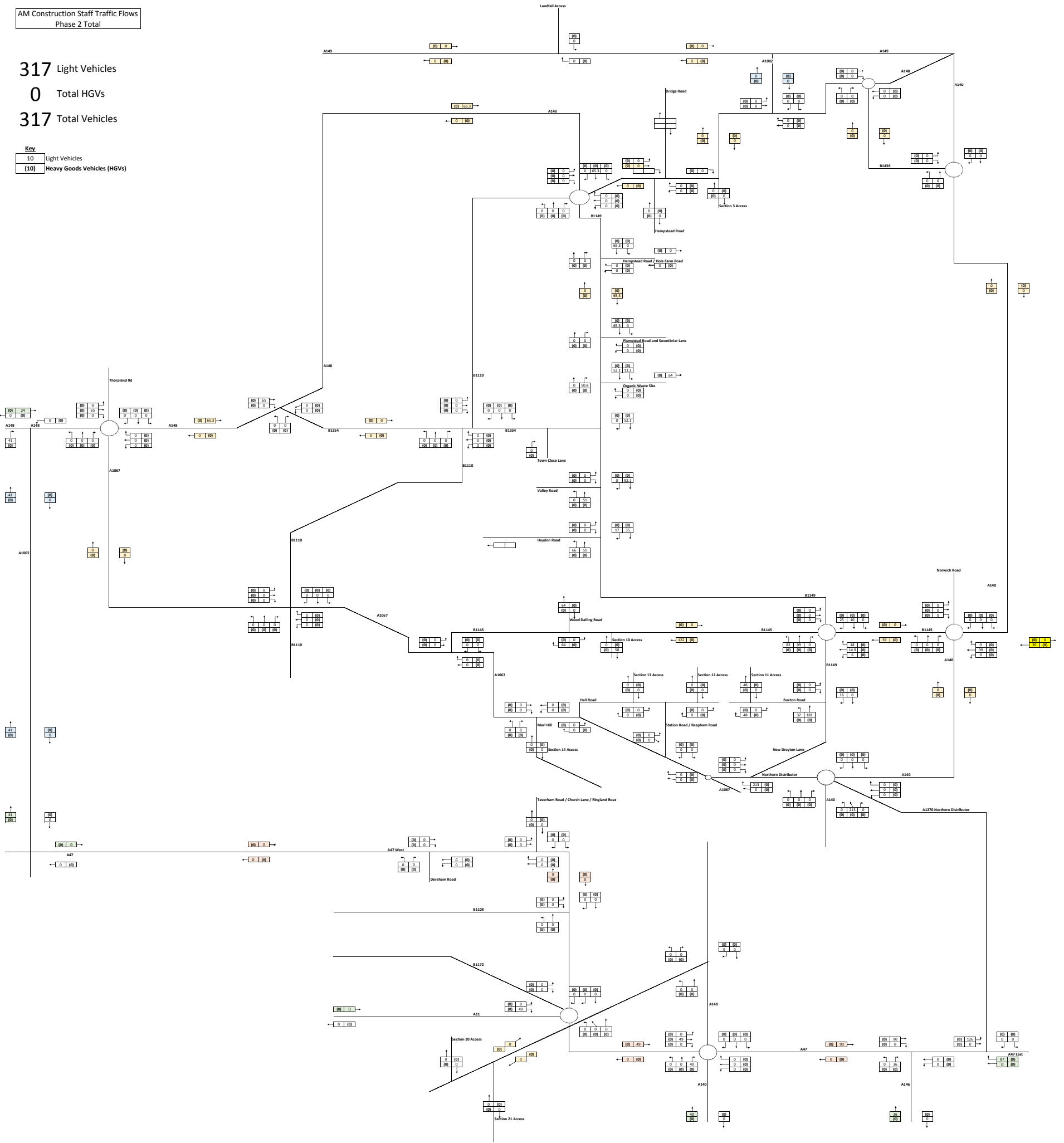

HGVS		Staff Vehicle Movements	
Assume		Assume	
25%	from Kings Lynn via A148	28%	via A148
25%	from Great Yarmouth	28%	via A47 east
25%	from Lowestoft	13%	from A146
50%	from A47	7%	from A47 west
0%	from A1065	0%	from A1065
50%	from A11	10%	from A11
25%	from A140 south	13%	from A140 south
25%	from A140 north	12%	from A140 north
		12%	from A140 north

35 Light Vehicles

0 Total HGVs

AM Construction Staff Traffic Flows
Route Section 12

Key	
10	Light Vehicles
(10)	Heavy Goods Vehicles (HGVs)

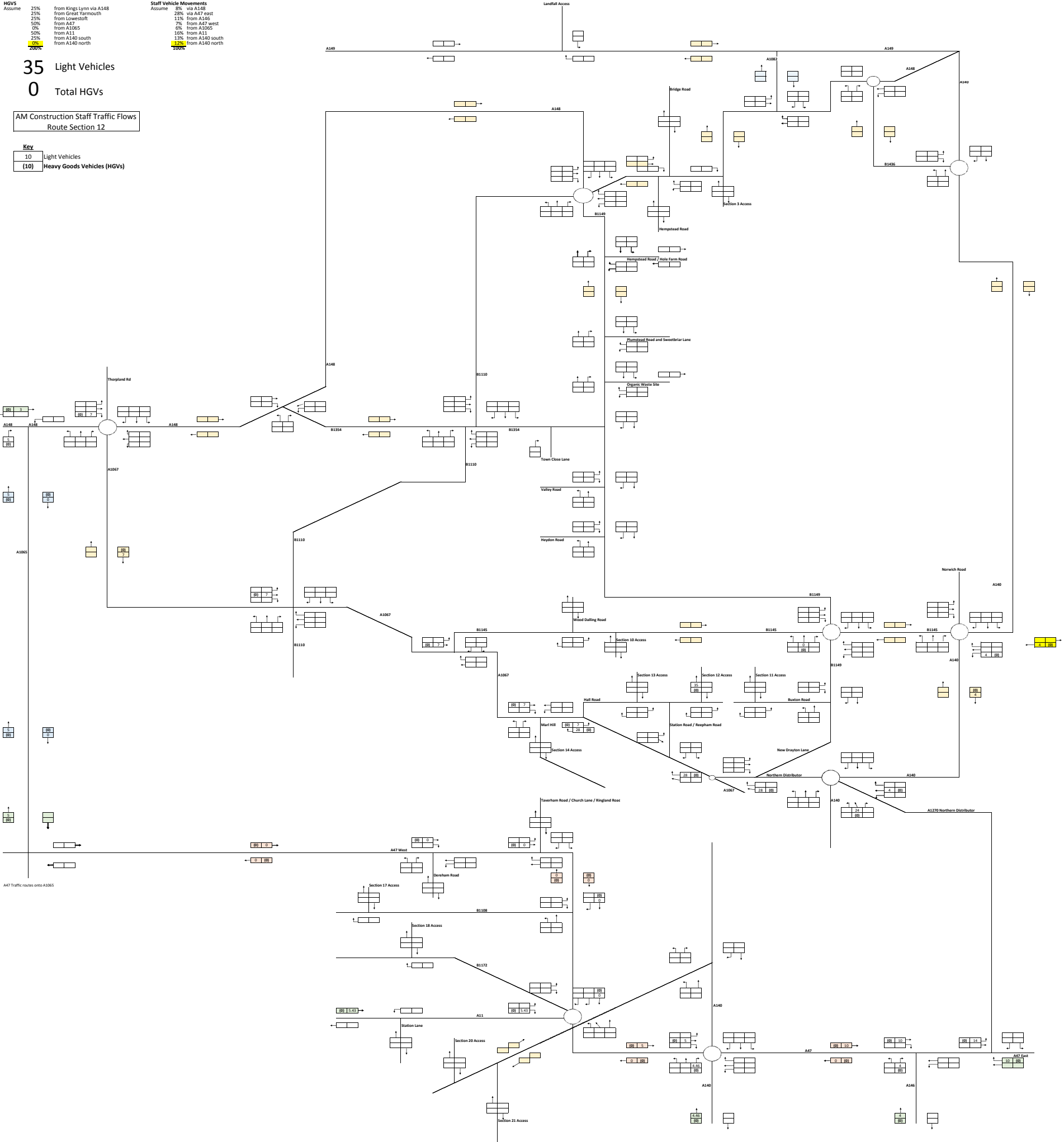

HGVS		Staff Vehicle Movements	
Assume		Assume	
25%	from Kings Lynn via A148	30%	via A148
25%	from Great Yarmouth	28%	via A47 east
25%	from Lowestoft	13%	from A146
50%	from A47	7%	from A47 west
0%	from A1065	0%	from A1065
50%	from A11	10%	from A11
25%	from A140 south	13%	from A140 south
25%	from A140 north	12%	from A140 north
25%		12%	

48 Light Vehicles
0 Total HGVs

AM Construction Staff Traffic Flows
 Route Section 13

Key	
10	Light Vehicles
(10)	Heavy Goods Vehicles (HGVs)

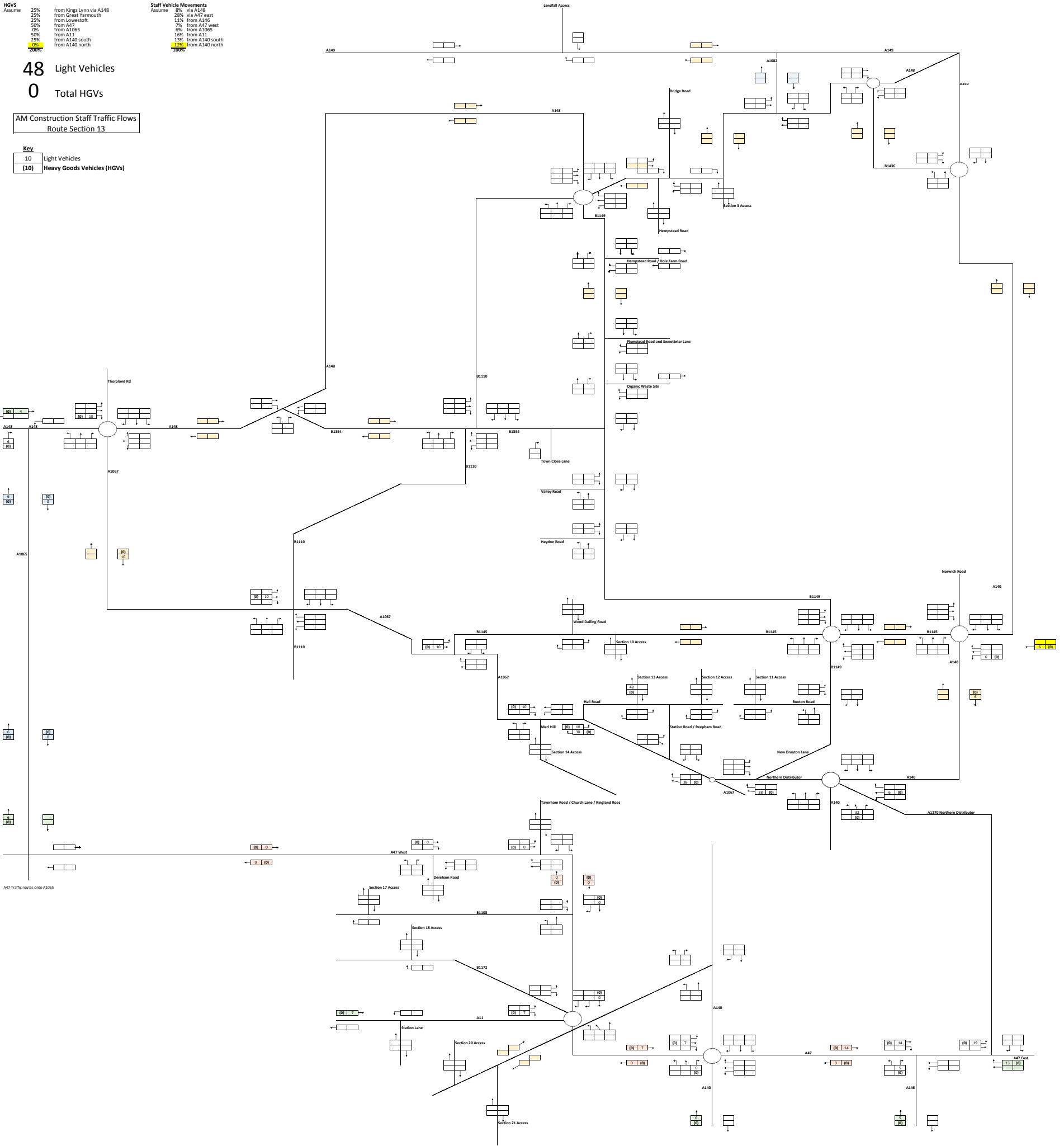

HGVs		Staff Vehicle Movements	
Assume	25%	Assume	8%
	from Kings Lynn via A148		via A148
	25%		28%
	from Great Yarmouth		via A47 east
	25%		11%
	from Lowestoft		from A146
	50%		7%
	from A47		from A47 west
	0%		6%
	from A1065		from A11
	50%		10%
	from A11		13%
	25%		from A140 south
	from A140 south		12%
	from A140 north		12%
	from A140 north		12%

97 Light Vehicles

0 Total HGVs

AM Construction Staff Traffic Flows
Route Section 14

Key	
10	Light Vehicles
(10)	Heavy Goods Vehicles (HGVs)

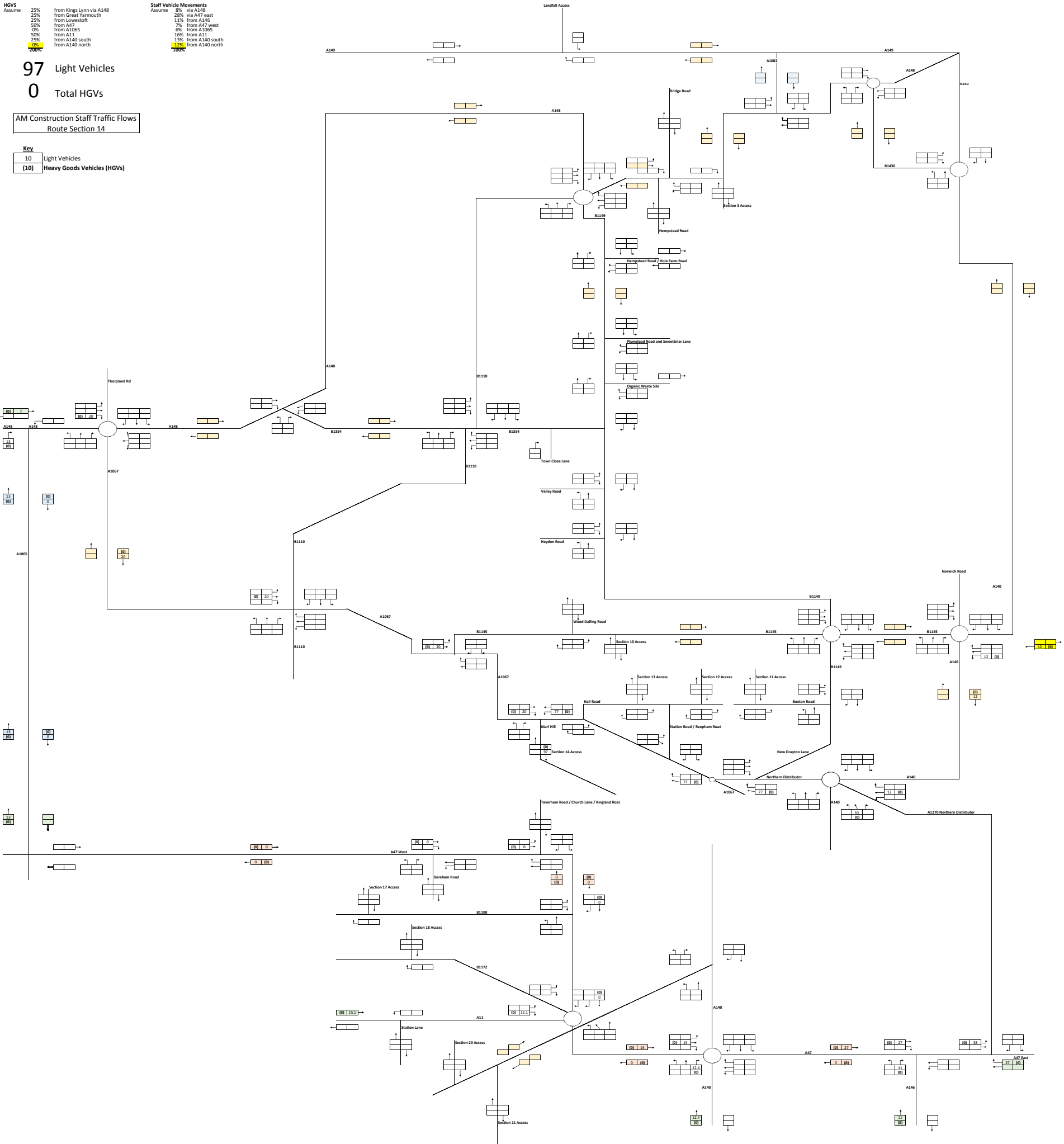

HGVs		Staff Vehicle Movements	
Assume	25%	Assume	25%
	from Kings Lynn via A148		via A148
	25%		28%
	from Great Yarmouth		via A47 east
	25%		11%
	from Lowestoft		from A146
	50%		7%
	from A47		from A47 west
	0%		6%
	from A1065		from A11
	50%		10%
	from A11		13%
	25%		from A140 south
	from A140 south		12%
	from A140 north		from A140 north
	25%		10%

42 Light Vehicles

0 Total HGVs

AM Construction Staff Traffic Flows
Route Section 15

Key	
10	Light Vehicles
(10)	Heavy Goods Vehicles (HGVs)

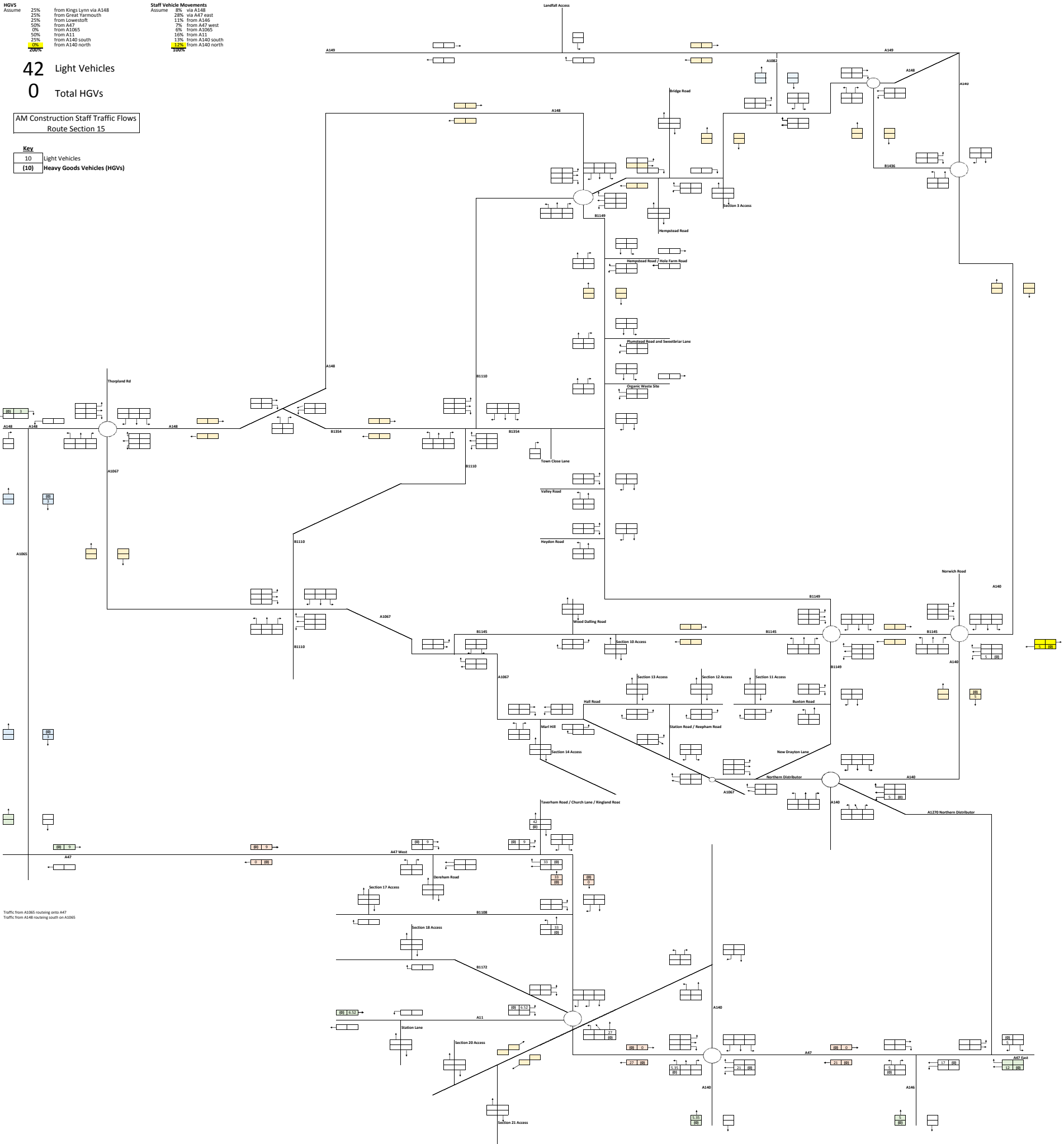

Traffic from A1065 routing onto A47
Traffic from A148 routing south via A1065

HGVs	25%	from Kings Lynn via A148	
Assume	25%	from Great Yarmouth	
	25%	from Lowestoft	
	50%	from A47	
	0%	from A1065	
	50%	from A11	
	25%	from A140 south	
	75%	from A140 north	
	25%	via A148	
	28%	via A47 east	
	11%	from A146	
	7%	from A47 west	
	0%	from A1065	
	10%	from A11	
	13%	from A140 south	
	12%	from A140 north	
	12%	via A148	

Staff Vehicle Movements	Assume	25%	via A148
		28%	via A47 east
		11%	from A146
		7%	from A47 west
		0%	from A1065
		10%	from A11
		13%	from A140 south
		12%	from A140 north
		12%	via A148

64 Light Vehicles

0 Total HGVs

AM Construction Staff Traffic Flows
Route Section 16

Key	
10	Light Vehicles
(10)	Heavy Goods Vehicles (HGVs)

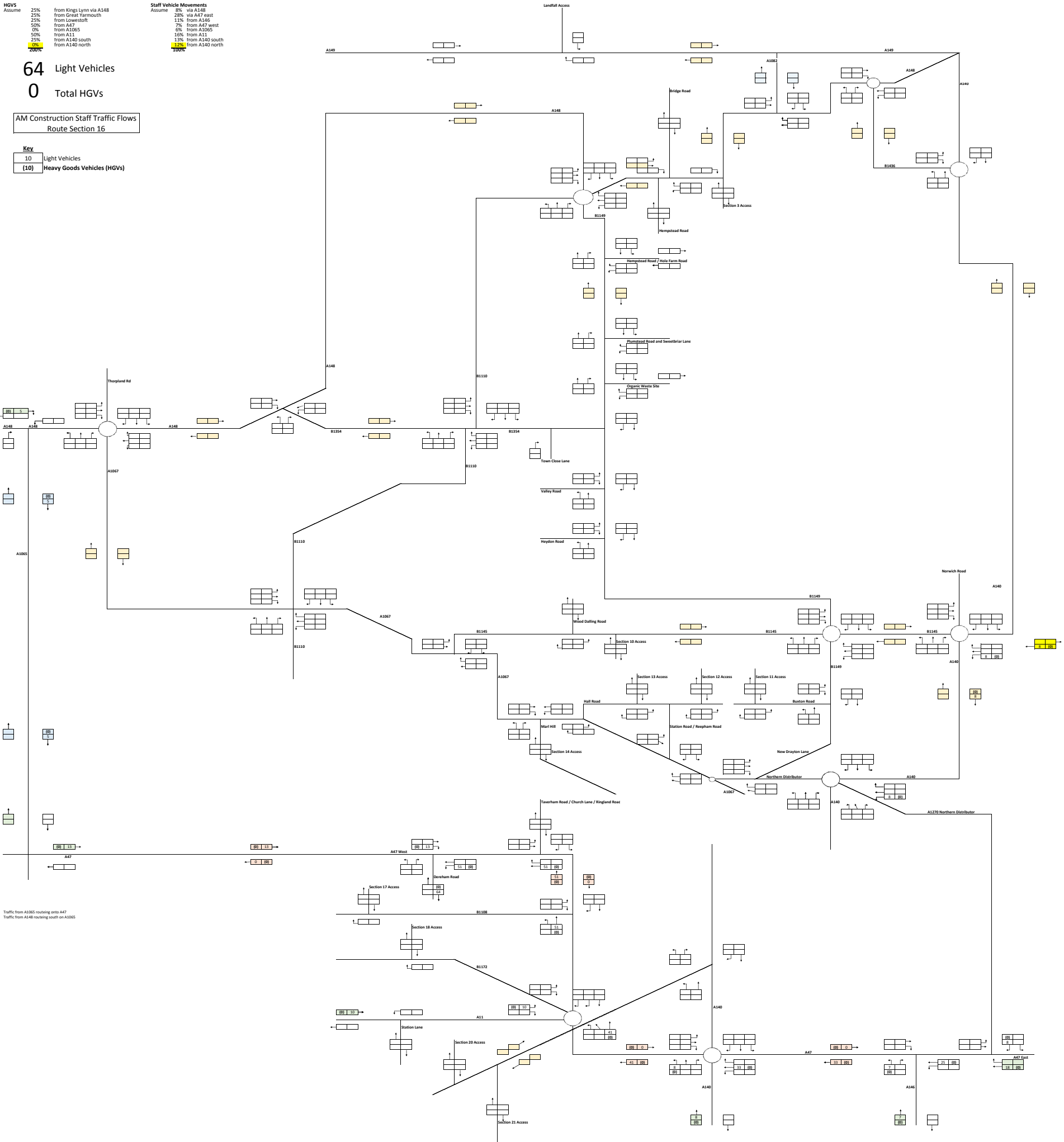

Traffic from A1065 routing onto A47
Traffic from A146 routing north via A1065

AM Construction Staff Traffic Flows
Phase 3 Total

286 Light Vehicles

0 Total HGVs

286 Total Vehicles

Key
 10 Light Vehicles
 (10) Heavy Goods Vehicles (HGVs)

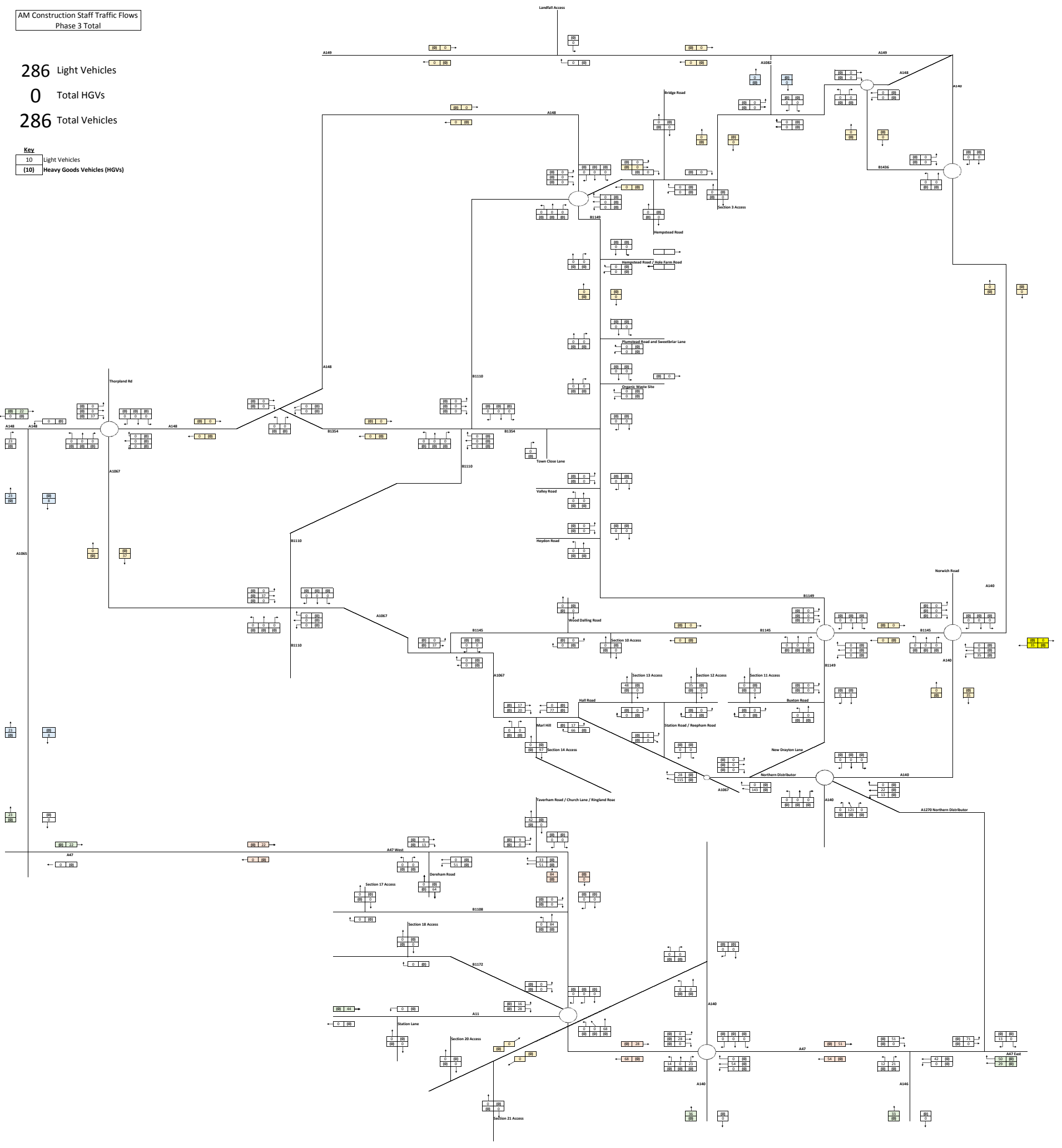

HGVS		Staff Vehicle Movements	
Assume	25%	Assume	25%
	from Kings Lynn via A148		via A148
	25%		28%
	from Great Yarmouth		via A47 east
	25%		11%
	from Lowestoft		from A146
	50%		7%
	from A47		from A47 west
	0%		6%
	from A1065		from A1065
	50%		10%
	from A11		from A11
	25%		13%
	from A140 south		from A140 south
	0%		12%
	from A140 north		from A140 north
	25%		10%

68 Light Vehicles

0 Total HGVs

AM Construction Staff Traffic Flows
Route Section 17

Key	
10	Light Vehicles
10	Heavy Goods Vehicles (HGVs)

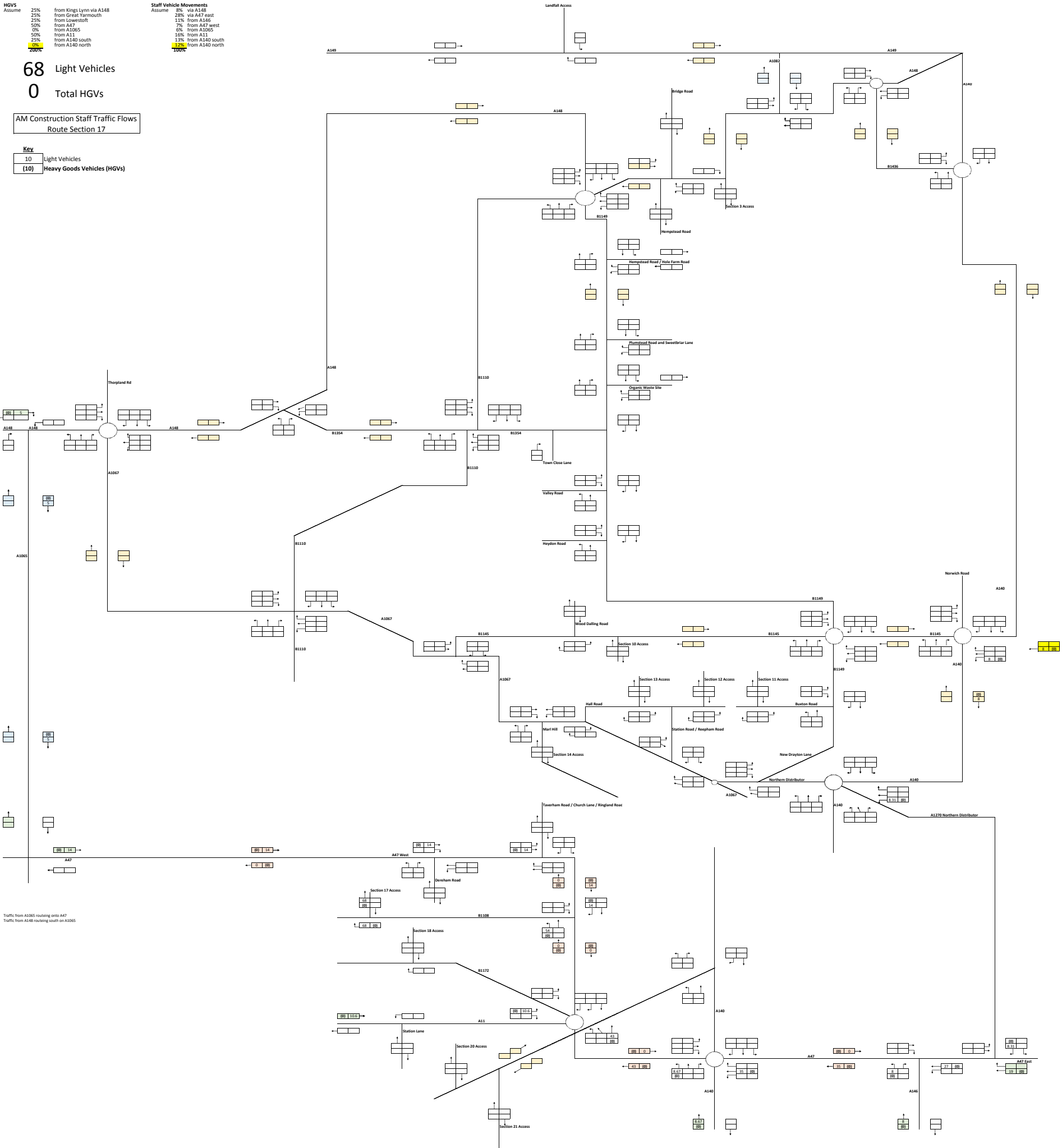

HGVs		Staff Vehicle Movements	
Assume	25%	Assume	25%
	from Kings Lynn via A148		via A148
	25%		28%
	from Great Yarmouth		via A47 east
	25%		11%
	from Lowestoft		from A146
	50%		7%
	from A47		from A47 west
	0%		6%
	from A1065		from A1065
	50%		10%
	from A11		from A11
	25%		13%
	from A140 south		from A140 south
	0%		12%
	from A140 north		from A140 north
	25%		10%

116 Light Vehicles

0 Total HGVs

AM Construction Staff Traffic Flows
Route Section 18

Key	
10	Light Vehicles
(10)	Heavy Goods Vehicles (HGVs)

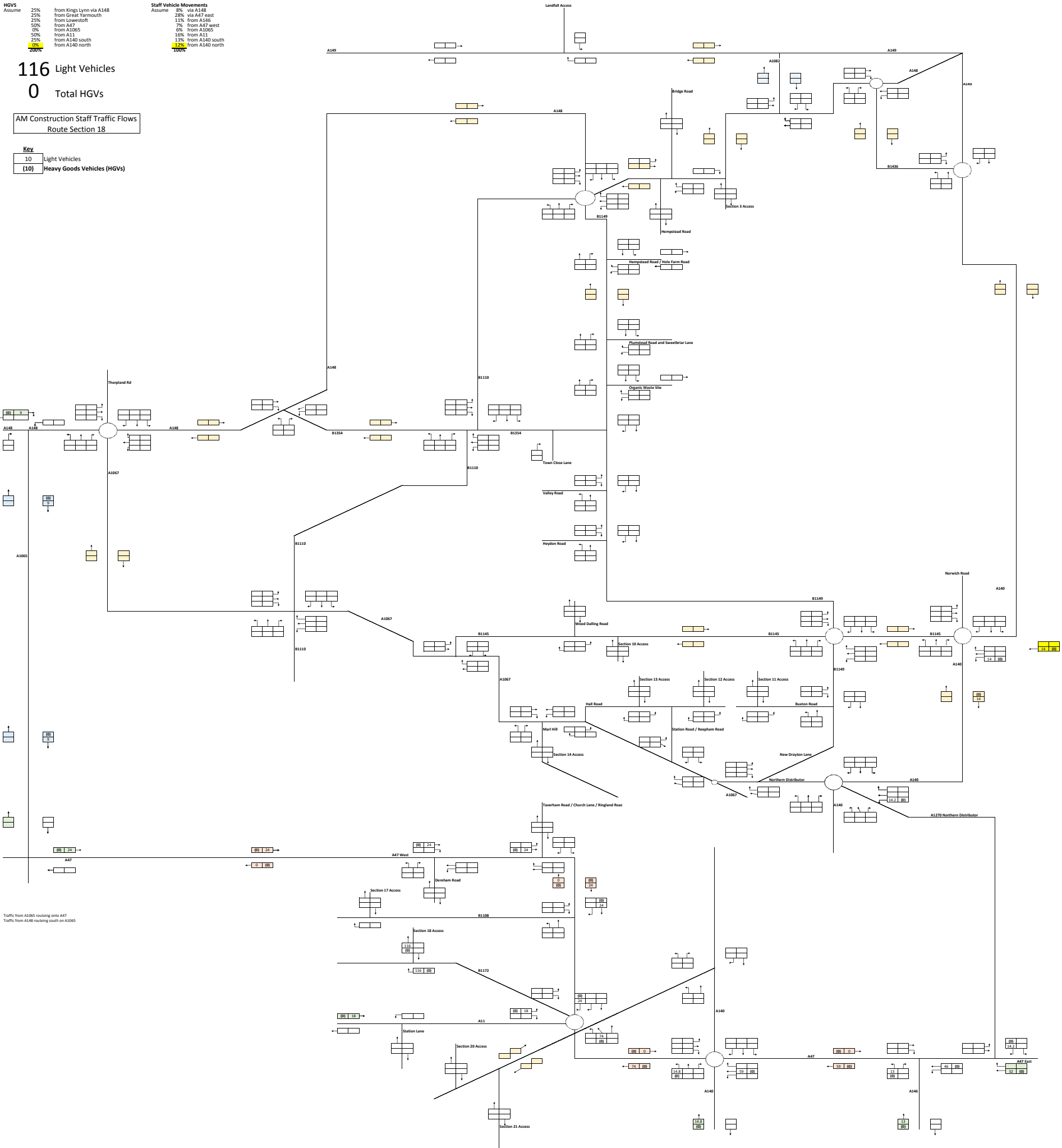

HGVS		Staff Vehicle Movements	
Assume	25%	Assume	8%
	from Kings Lynn via A148		via A148
	25%		28%
	from Great Yarmouth		via A47 east
	25%		11%
	from Lowestoft		from A146
	50%		7%
	from A47		from A47 west
	0%		6%
	from A1065		10%
	50%		from A11
	25%		13%
	from A140 south		from A140 south
	0%		12%
	from A140 north		from A140 north
	25%		10%

54 Light Vehicles

0 Total HGVs

AM Construction Staff Traffic Flows
Route Section 19

Key	
10	Light Vehicles
(10)	Heavy Goods Vehicles (HGVs)

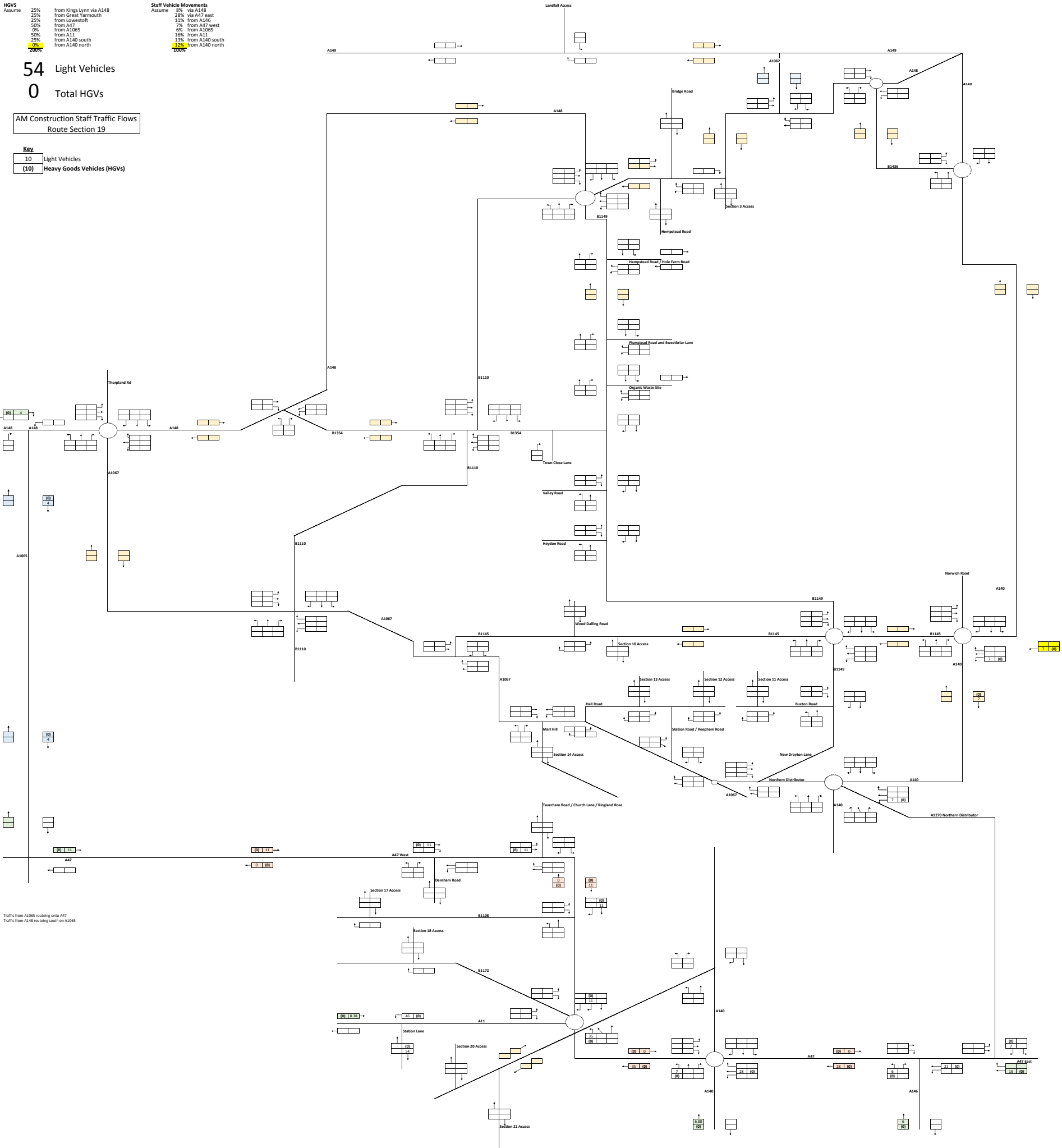

HGVs		Staff Vehicle Movements	
Assume	25%	Assume	25%
	from Kings Lynn via A148		via A148
	25%		28%
	from Great Yarmouth		via A47 east
	25%		11%
	from Lowestoft		from A146
	50%		7%
	from A47		from A47 west
	0%		6%
	from A1065		from A1065
	50%		10%
	from A11		from A11
	25%		13%
	from A140 south		from A140 south
	0%		12%
	from A140 north		from A140 north
	25%		10%

54 Light Vehicles

0 Total HGVs

AM Construction Staff Traffic Flows
Route Section 20

Key	
10	Light Vehicles
10	Heavy Goods Vehicles (HGVs)

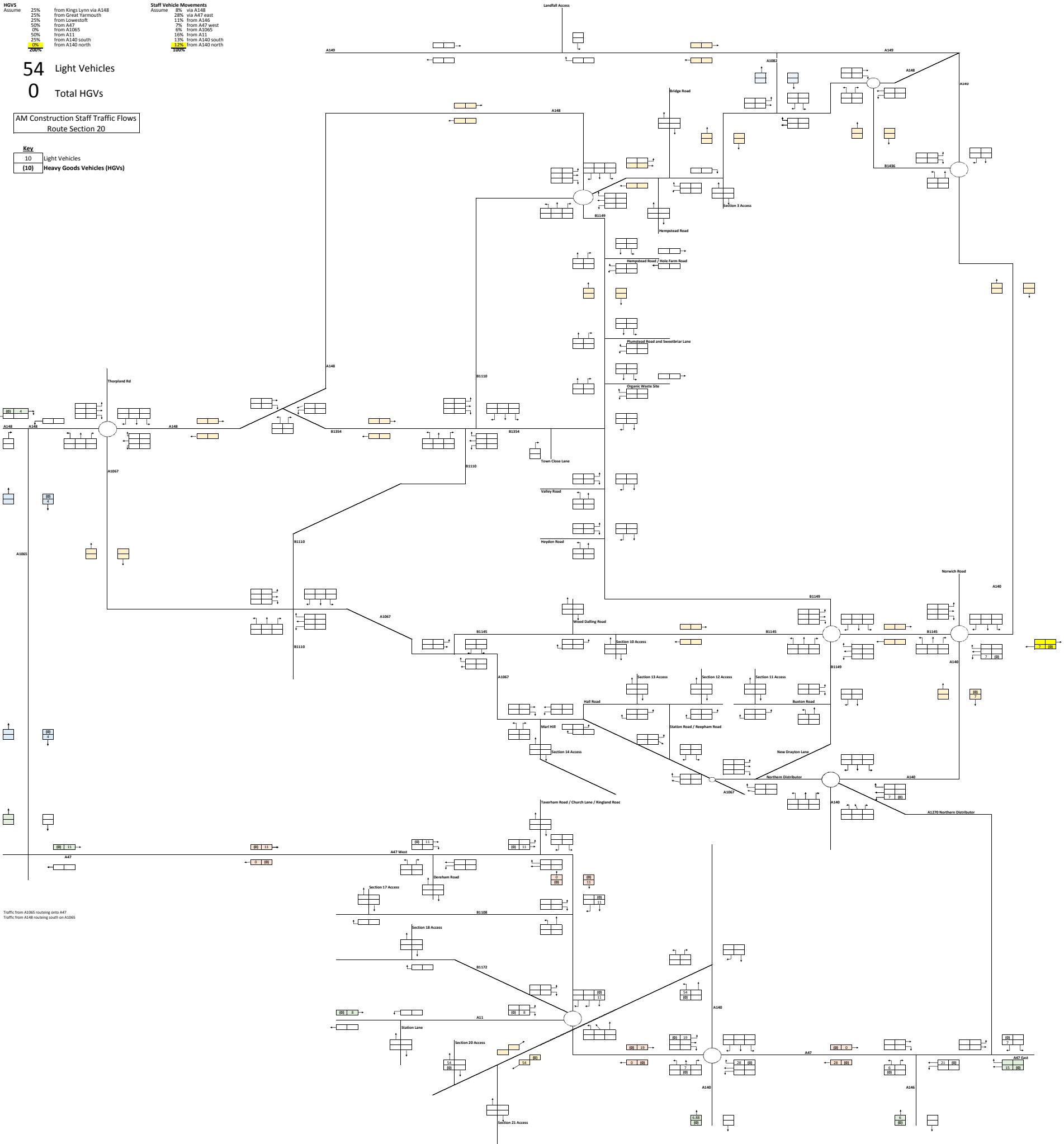

Traffic from A1065 routing onto A47
Traffic from A148 routing south via A1065

HGVs		Staff Vehicle Movements	
Assume	25%	Assume	8%
	from Kings Lynn via A148		via A148
	25%		28%
	from Great Yarmouth		via A47 east
	25%		11%
	from Lowestoft		from A146
	50%		7%
	from A47		from A47 west
	0%		6%
	from A1065		from A1065
	50%		10%
	from A11		from A11
	25%		13%
	from A140 south		from A140 south
	0%		12%
	from A140 north		from A140 north
	25%		10%

64 Light Vehicles
0 Total HGVs

AM Construction Staff Traffic Flows
Route Section 21

Key	
10	Light Vehicles
10	Heavy Goods Vehicles (HGVs)

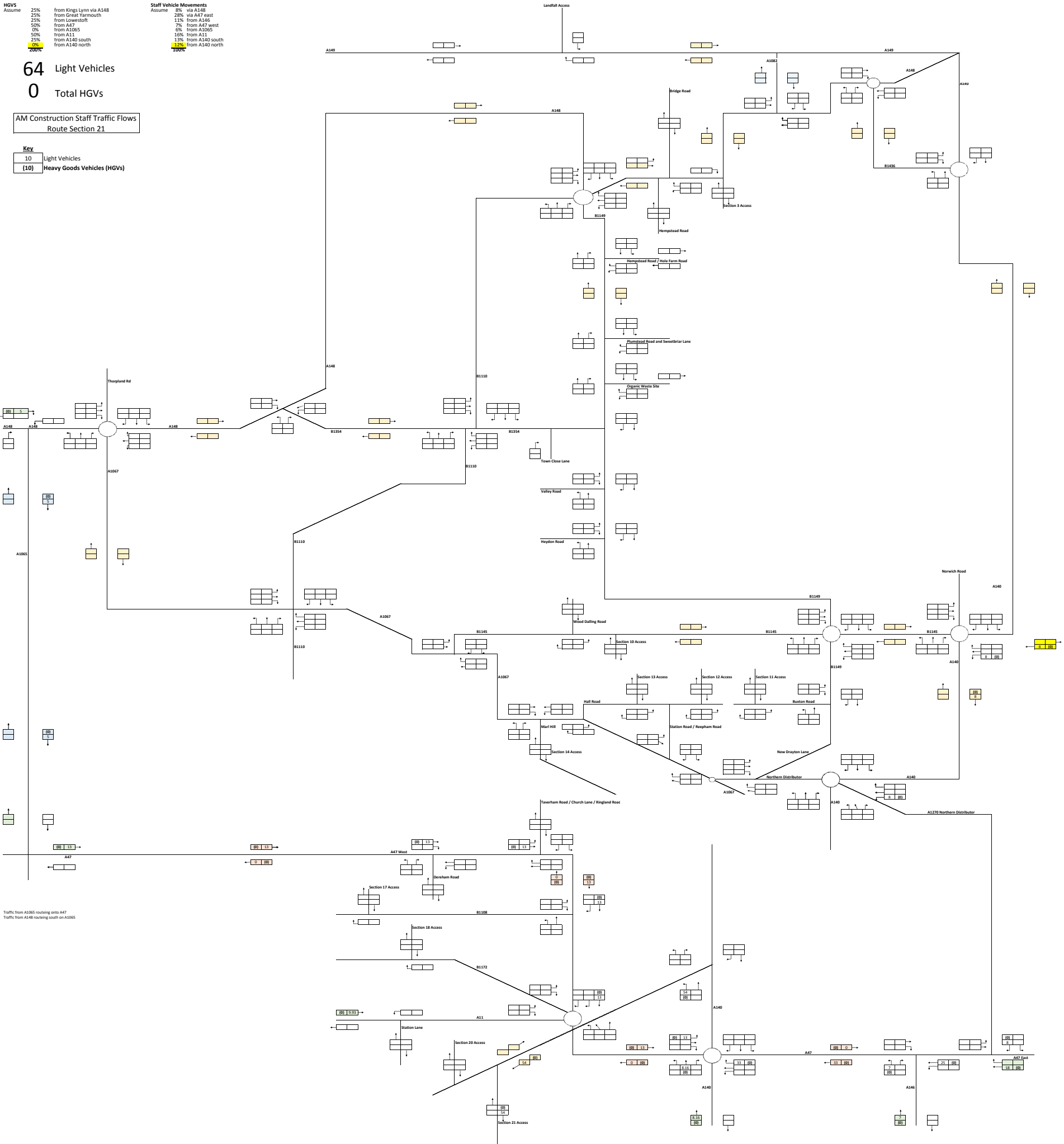

Traffic from A1065 routing onto A47
Traffic from A148 routing south via A1065

HGVs	Assume	25%	from Kings Lynn via A148
		25%	from Great Yarmouth
		25%	from Lowestoft
		50%	from A47
		0%	from A1065
		50%	from A11
		25%	from A140 south
		25%	from A140 north
		25%	from A140 north
		25%	from A140 north

Staff Vehicle Movements	Assume	8%	via A148
		28%	via A47 east
		11%	from A146
		7%	from A47 west
		6%	from A1065
		16%	from A11
		13%	from A140 south
		12%	from A140 north
		12%	from A140 north

5 Light Vehicles
0 Total HGVs

AM Construction Staff Traffic Flows
Landfall

Key	
10	Light Vehicles
10	Heavy Goods Vehicles (HGVs)

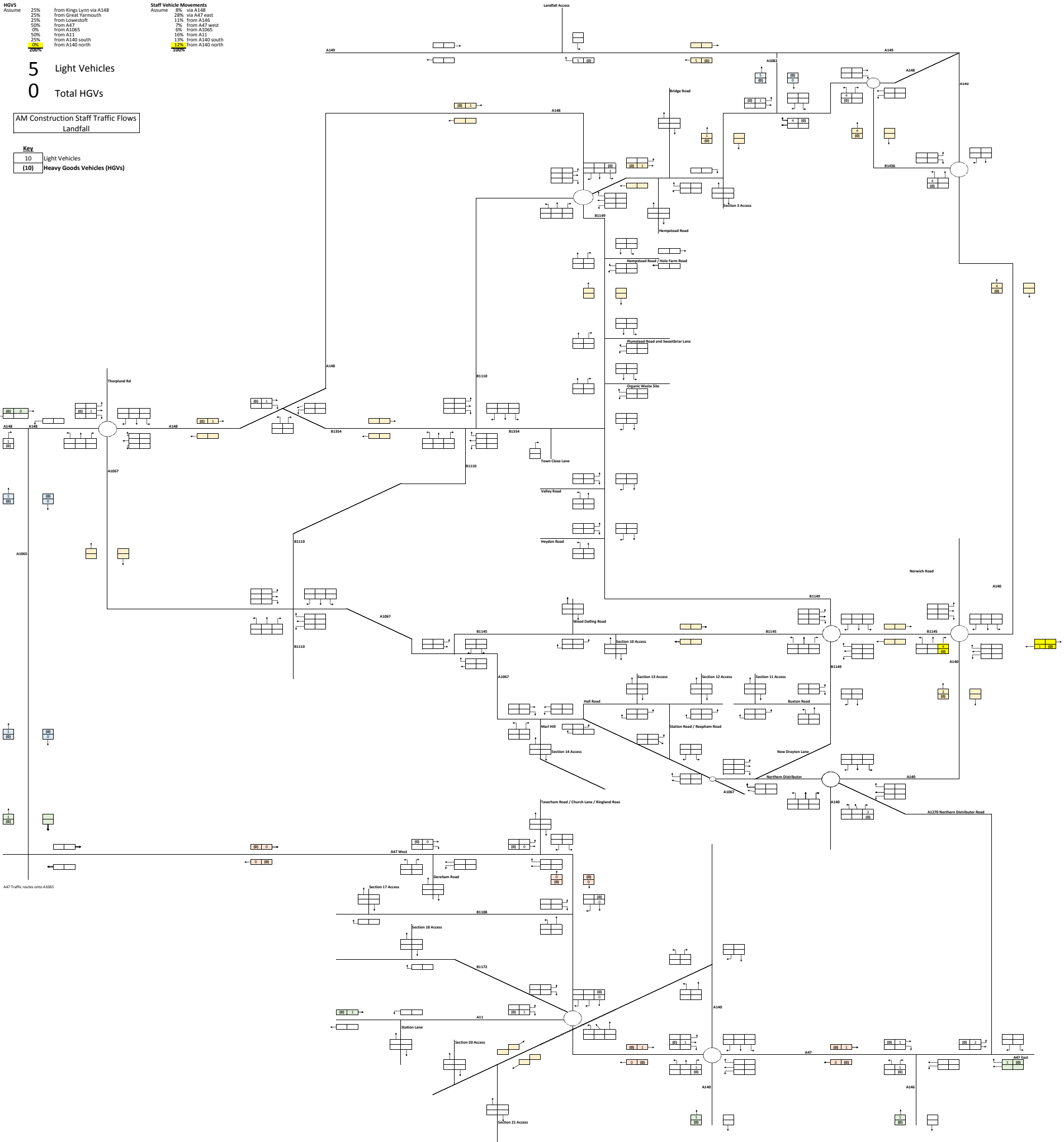

A47 Traffic routes onto A1065

HGVs	25%	from Kings Lynn via A148	Staff Vehicle Movements	28%	via A148
Assume	25%	from Great Yarmouth	Assume	11%	from A146
	25%	from Lowestoft		7%	from A47 west
	50%	from A47		6%	from A105
	0%	from A105		10%	from A11
	50%	from A140 south		13%	from A140 south
	25%	from A140 north		12%	from A140 north
	25%	from A140 north		12%	from A140 north

17 Light Vehicles

0 Total HGVs

AM Construction Staff Traffic Flows
HVAC Booster Station

Key	
10	Light Vehicles
(10)	Heavy Goods Vehicles (HGVs)

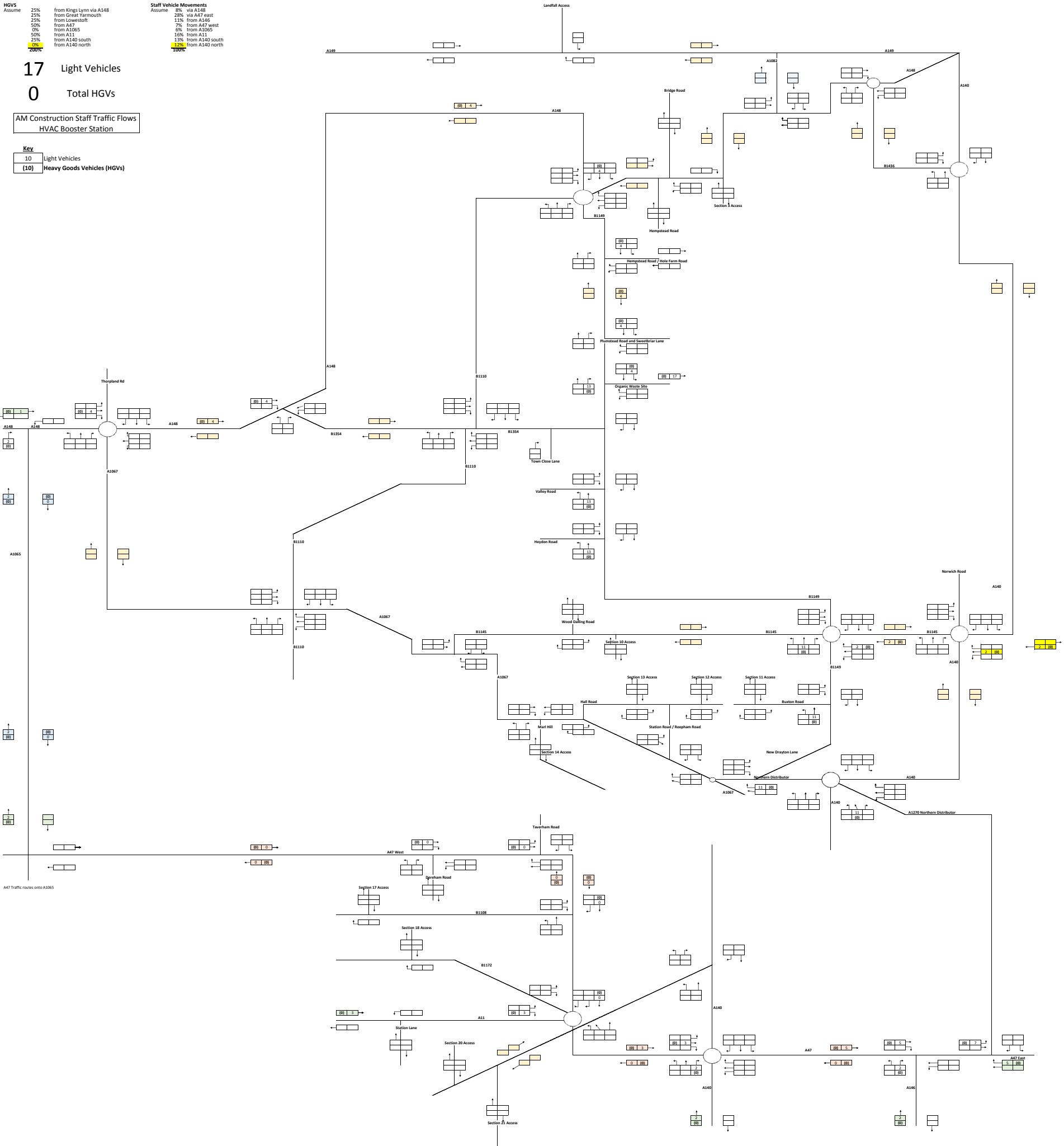

HGVs		Staff Vehicle Movements	
Assume		Assume	
25%	from Kings Lynn via A148	8%	via A148
25%	from Great Yarmouth	28%	via A47 east
25%	from Lowestoft	11%	from A146
50%	from A47	7%	from A47 west
0%	from A1065	0%	from A1065
50%	from A11	10%	from A11
25%	from A140 south	13%	from A140 south
25%	from A140 north	12%	from A140 north
200%		100%	

41 Light Vehicles

0 Total HGVs

AM Construction Staff Traffic Flows
HVAC Substation

Key	
10	Light Vehicles
10	Heavy Goods Vehicles (HGVs)

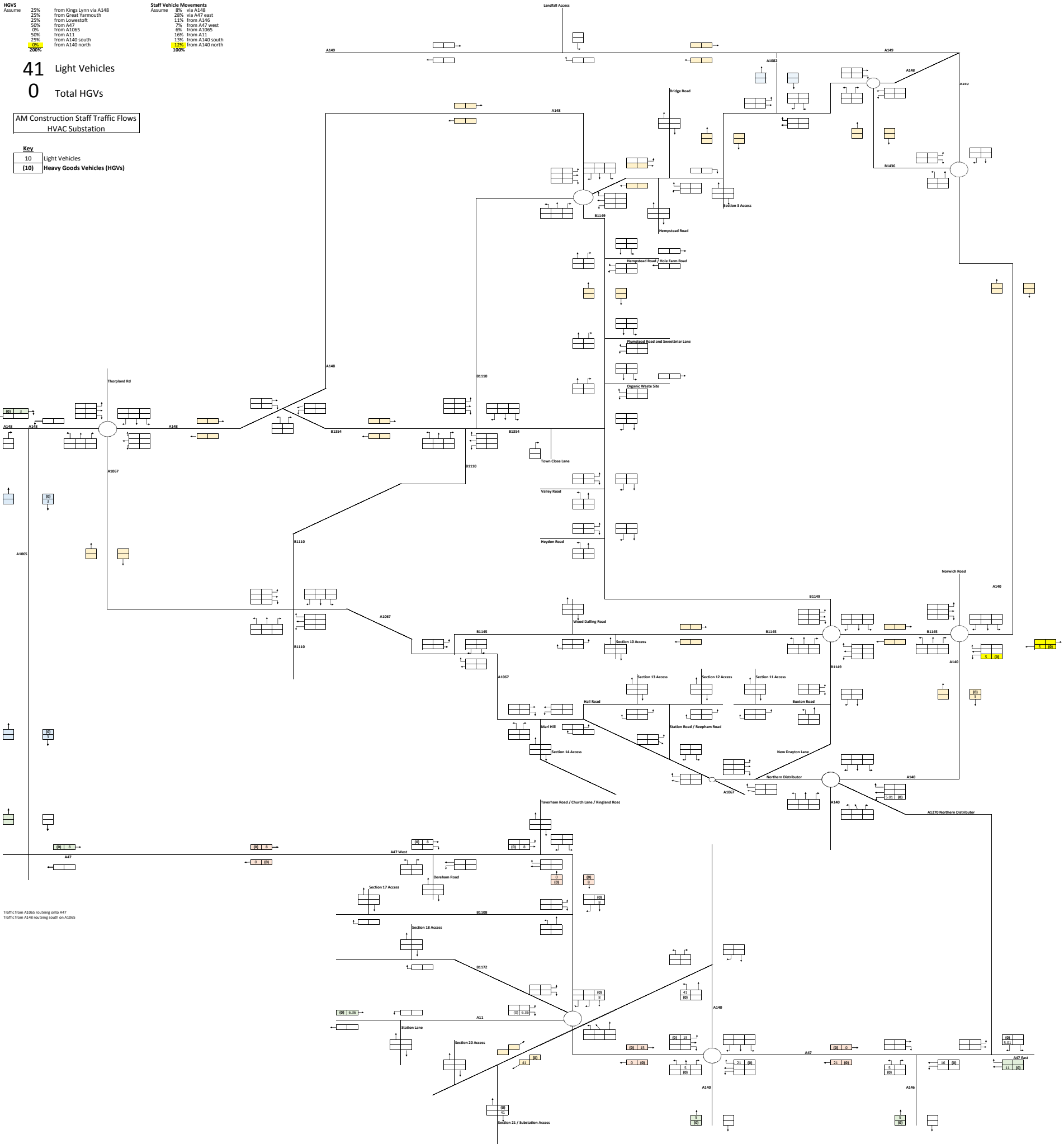

Traffic from A1065 routing onto A47
Traffic from A148 routing south via A1065

AM Construction Staff Traffic Flows
Maximum Construction Traffic

Light Vehicles

0 Total HGVs

Total Vehicles

Key	
10	Light Vehicles
10	Heavy Goods Vehicles (HGVs)

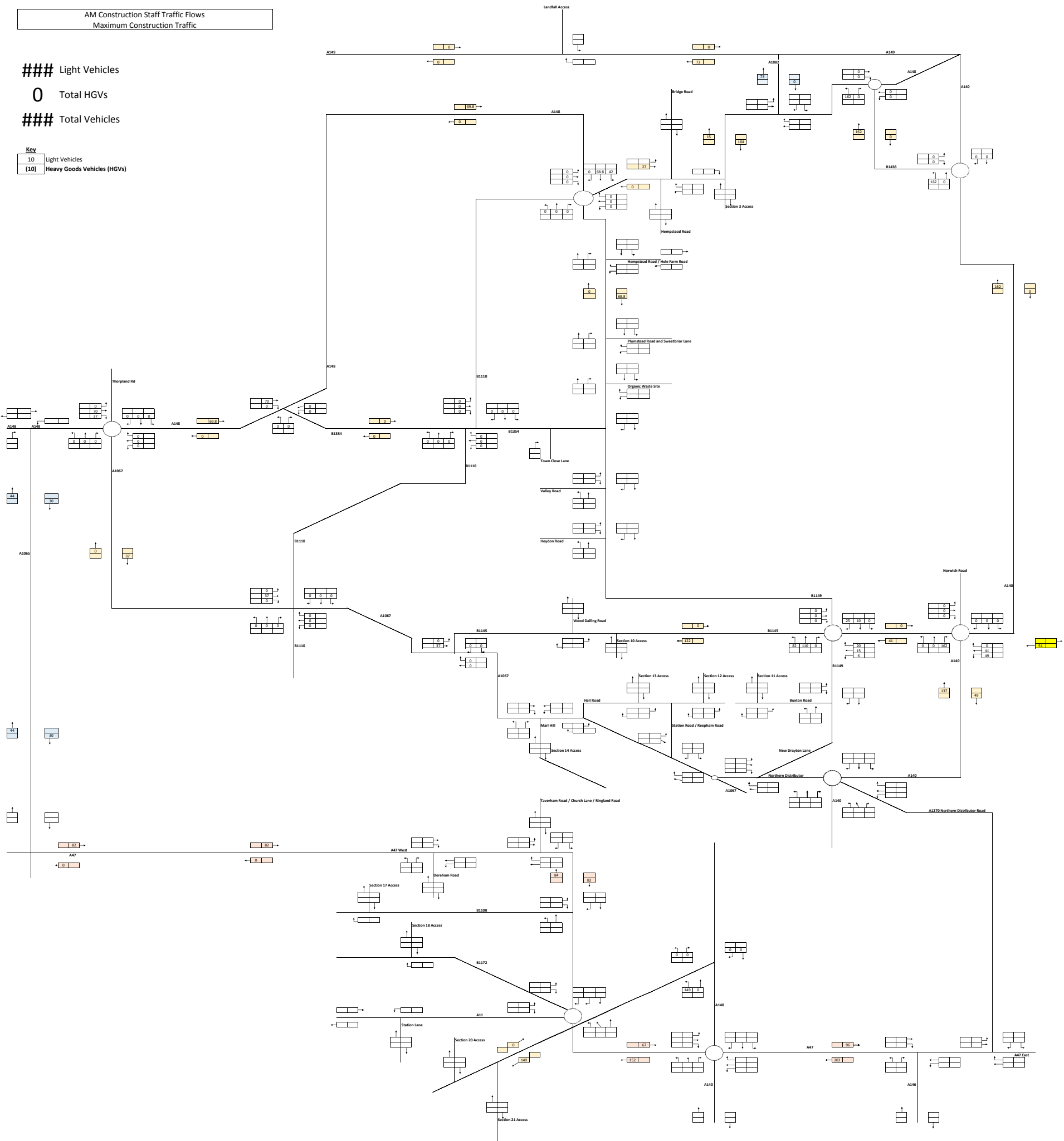

AM Construction Staff Traffic Flows
Total Construction Traffic

1,193 Light Vehicles
0 Total HGVs
1,193 Total Vehicles

Key	
10	Light Vehicles
(10)	Heavy Goods Vehicles (HGVs)

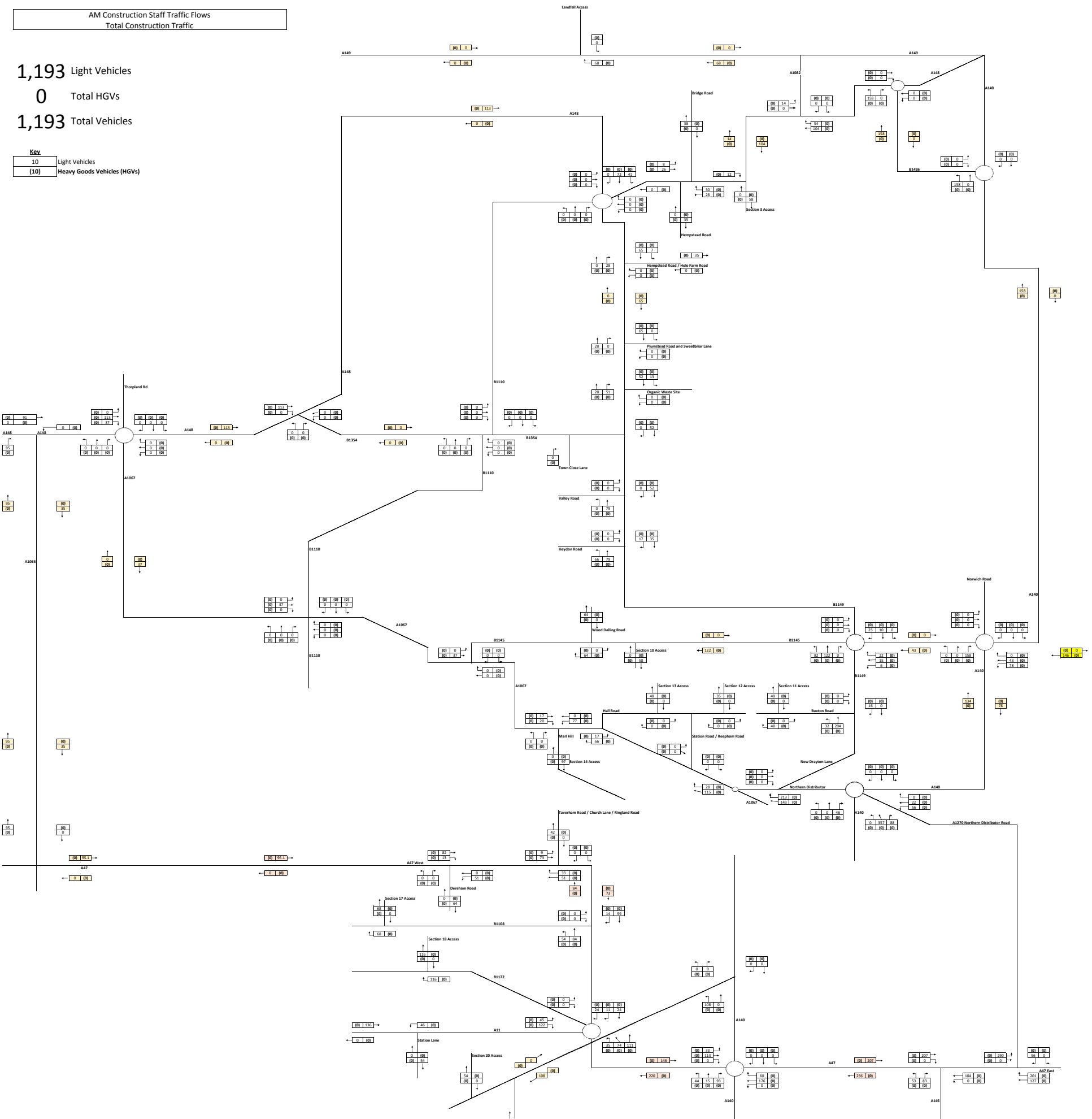

Traffic Flow Diagrams

Construction Staff Traffic Flows
PM (18:00-19:00)

2017 Observed Traffic Flows

18:00-19:00

Key
10 Total Vehicles
(10) Heavy Goods Vehicles (HGVs)

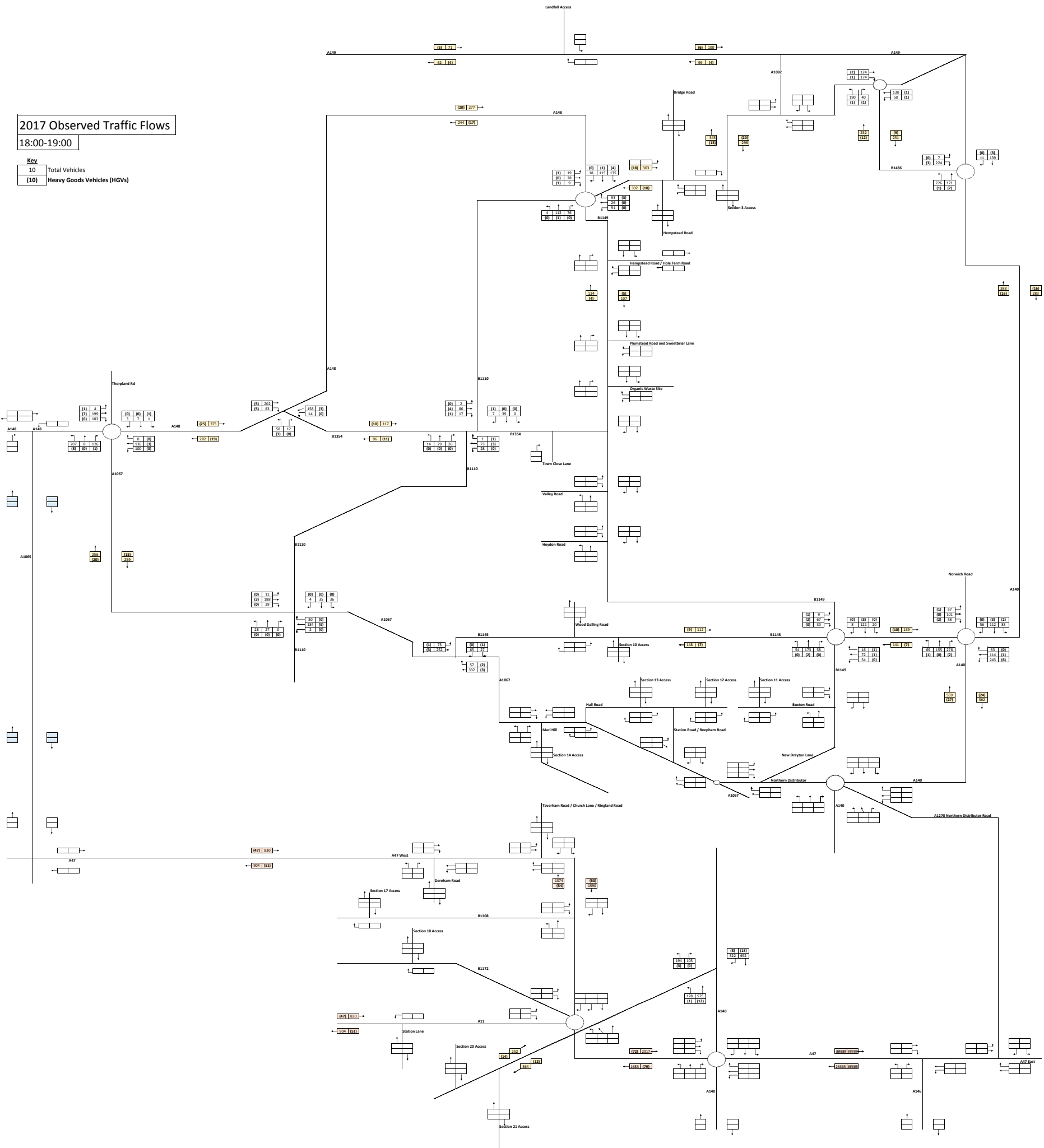

TEMPRO	
Average Weekday	
Thurs	growth 2017-2022
Principal	growth 2017-2022
Minor	growth 2017-2022

2022 Base Traffic Flows
18:00-19:00

Key	
10	Total Vehicles
10	Heavy Goods Vehicles (HGVs)

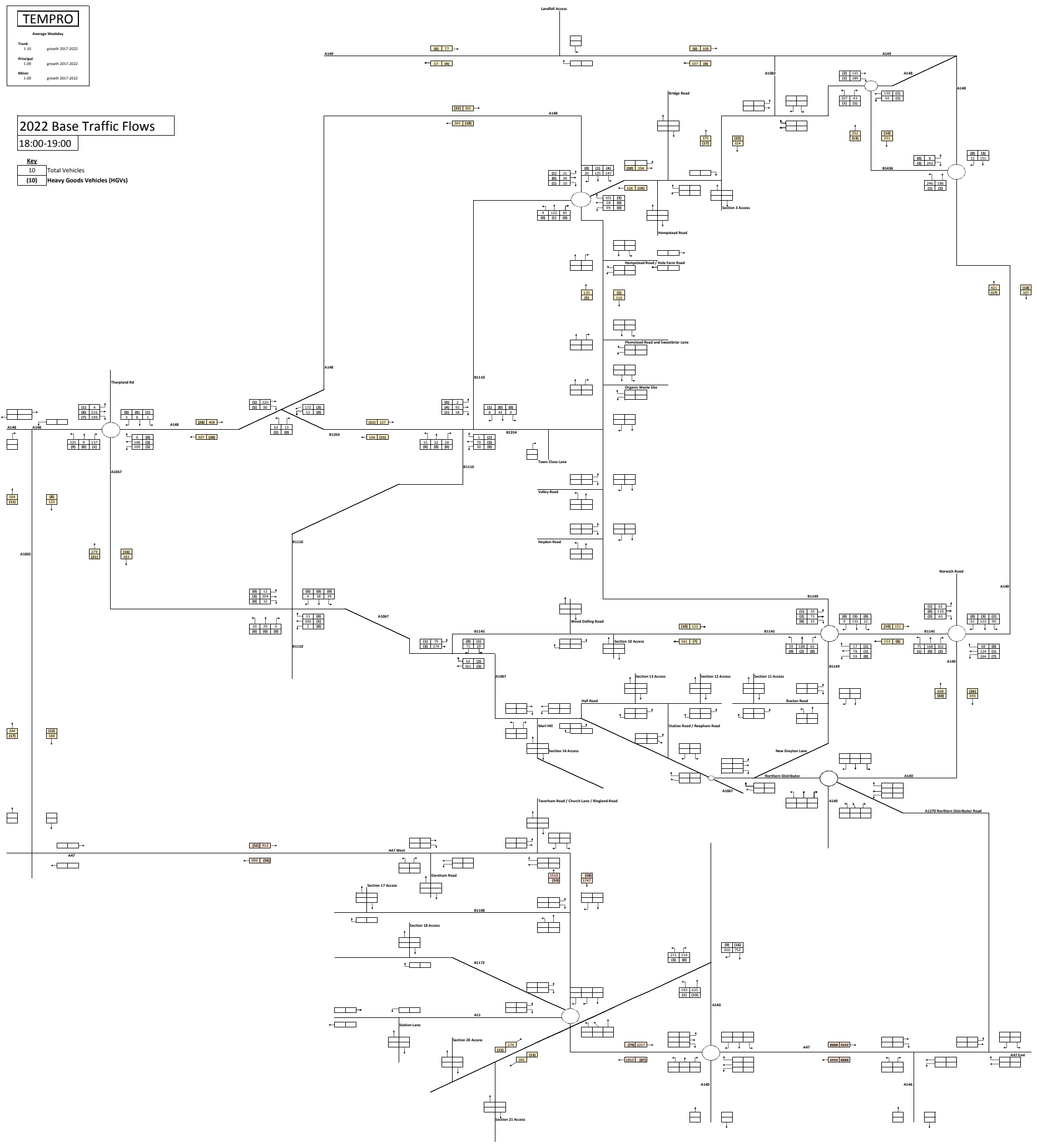

Construction Vehicle Movements Spreadsheet

Route Section	Description	Staff Peak Hour Vehicle Flows			Phase
		Total	HGV	Lights	
1	Landfall to Holgate Hill	68	0	68	1
2	Holgate Hill to woodland north east of High Kelling	38	0	38	1
3	Woodland northeast of High Kelling to woodland south of Church Road	58	0	58	1
4	Woodland south of Church Road to woodland south and east of School Lane	35	0	35	1
5	Woodland east of School Lane to Plumstead Road	35	0	35	1
6	Plumstead Road to the B1149	64	0	64	2
7	B1149 to land South of Town Close Lane	38	0	38	-
8	Land south of Town Close Lane to woodland north of Reepham Road	83	0	83	2
9	Land north of Reepham Road to woodland north of Reepham	64	0	64	2
10	Woodland north of Reepham to woodland at Booton Common	58	0	58	2
11	Woodland east of Reepham to The Grove	48	0	48	2
12	The Grove to woodland south of Church Farm Lane	35	0	35	3
13	Woodland south of Church Farm Lane to River Wensum	48	0	48	3
14	River Wensum to woodland south west of Ringland	97	0	97	3
15	Woodland south west of Ringland to A47	42	0	42	3
16	A47 to Bawburgh Road	64	0	64	3
17	Bawburgh Road to woodland west of Little Melton	68	0	68	4
18	Woodland west of Little Melton to A11	116	0	116	4
19	A11 to woodland north west of Swardeston	54	0	54	4
20	Woodland north west of Swardeston to B1113	54	0	54	4
21	B1113 to end of cable route	64	0	64	4
Landfall	Landfall	5	0	5	
Booster Station	Booster Station	17	0	17	
Converter / Sub Station	Converter / Sub Station	41	0	41	
Total:		1,294	0	1,294	1,294

HGVS		Staff Vehicle Movements	
Assume	25%	Assume	8%
	25%		28%
	25%		11%
	50%		7%
	0%		6%
	50%		16%
	25%		13%
	25%		12%
	25%		10%

68 Light Vehicles
0 Total HGVs

PM Construction Staff Traffic Flows
Route Section 1

Key	
10	Light Vehicles
(10)	Heavy Goods Vehicles (HGVs)

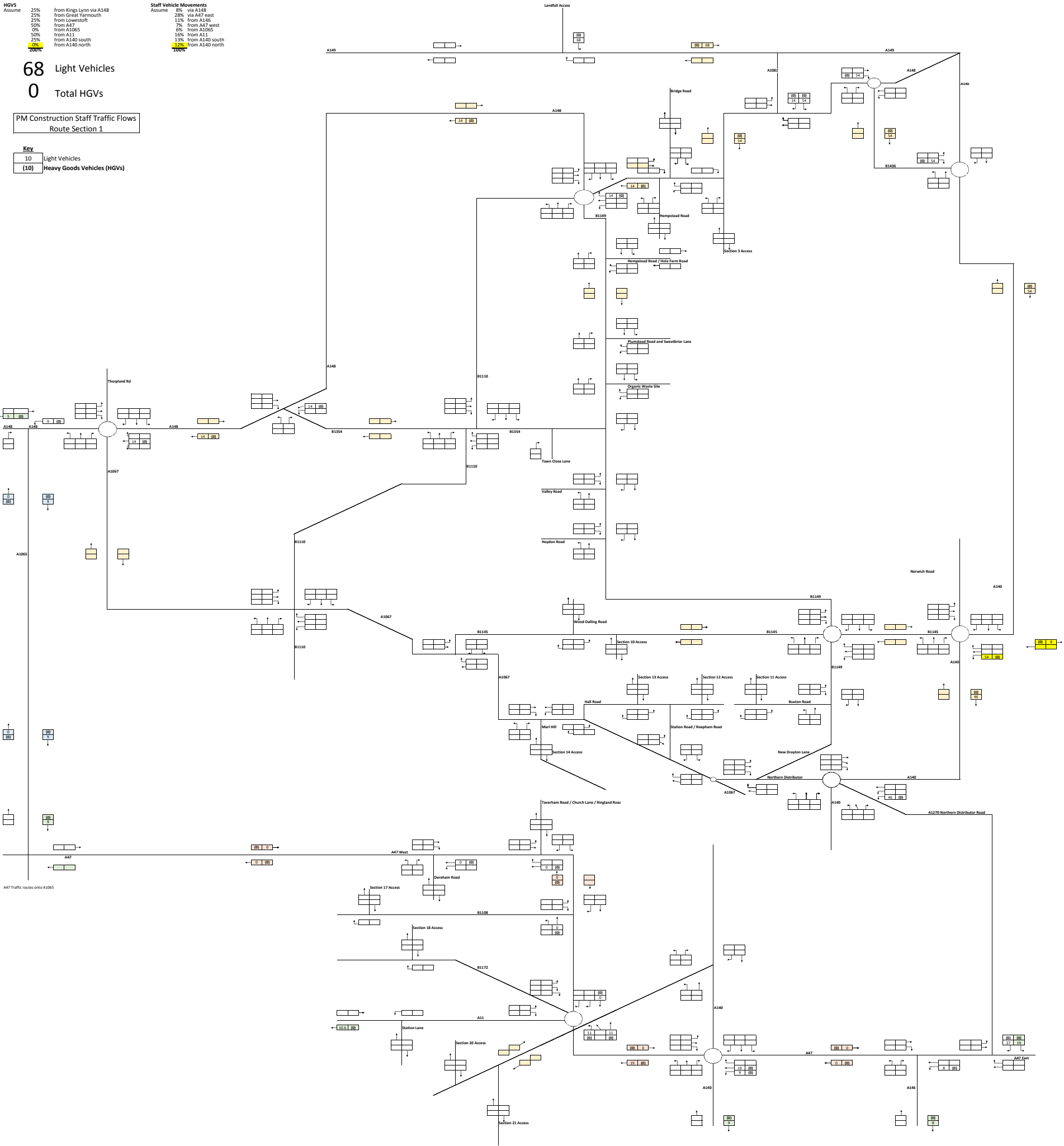

MVS Assume		Staff Vehicle Movements	
25%	from Kings Lynn via A148	8%	via A148
25%	from Great Yarmouth	28%	via A47 east
25%	from Lowestoft	11%	from A146
50%	from A47	7%	from A47 west
0%	from A1065	0%	from A1065
50%	from A11	16%	from A11
25%	from A140 south	13%	from A140 south
25%	from A140 north	12%	from A140 north
25%		10%	

38 Light Vehicles
0 Total HGVs

PM Construction Staff Traffic Flows
Route Section 2

Key	
10	Light Vehicles
(10)	Heavy Goods Vehicles (HGVs)

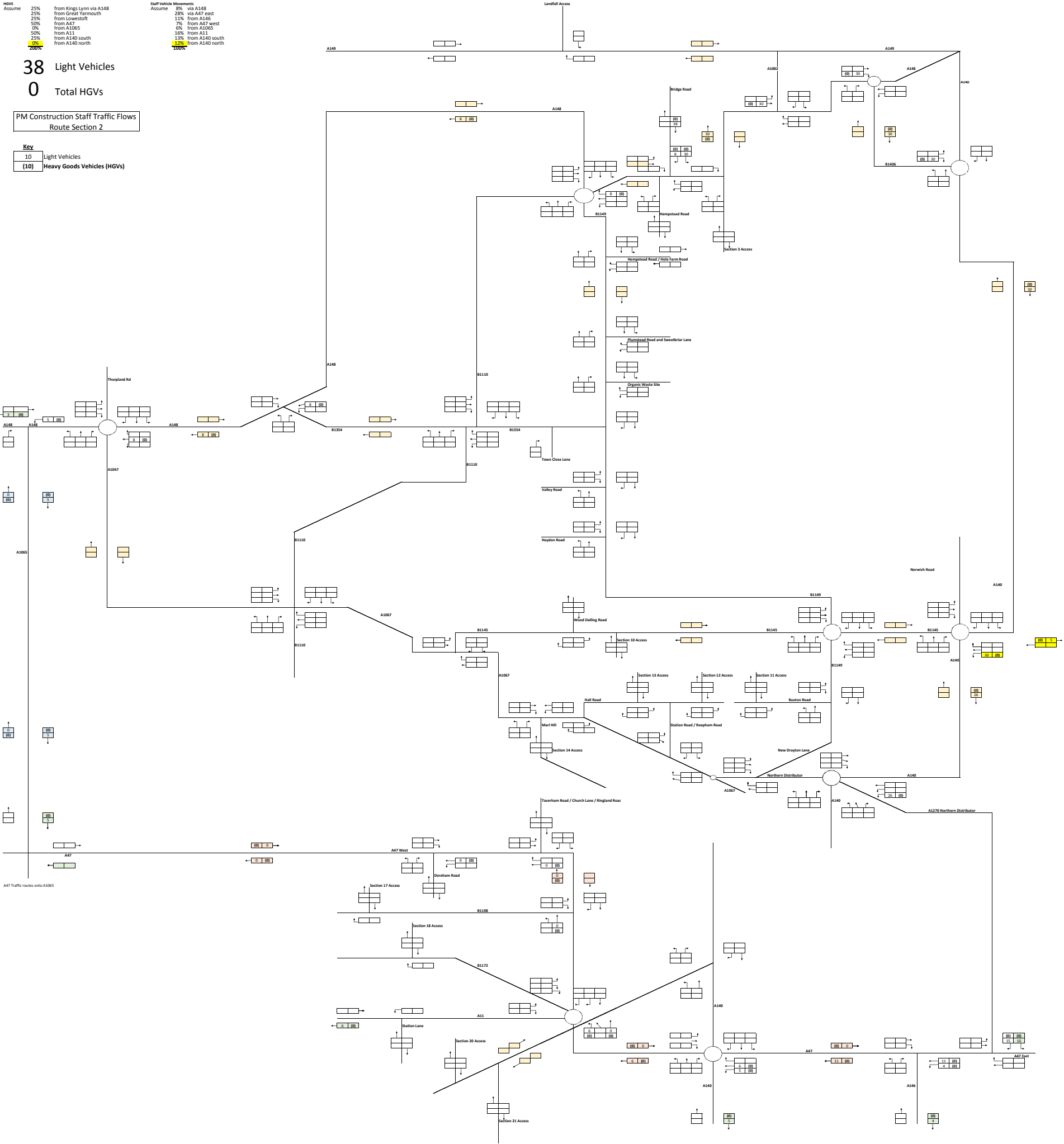

HGVS Assume	25%	from Kings Lynn via A148	Staff Vehicle Movements Assume	8%	via A148
	25%	from Great Yarmouth		28%	via A27 east
	25%	from Lowestoft	11%	from A148	
	50%	from A27	7%	from A27 west	
	0%	from A1085	6%	from A1085	
25%	50%	from A11	16%	from A11	
	25%	from A140 south	13%	from A140 south	
	25%	from A140 north	12%	from A140 north	
	25%		10%		
	25%				

58 Light Vehicles

0 Total HGVs

PM Construction Staff Traffic Flows Route Section 3

Key

10	Light Vehicles
(10)	Heavy Goods Vehicles (HGVs)

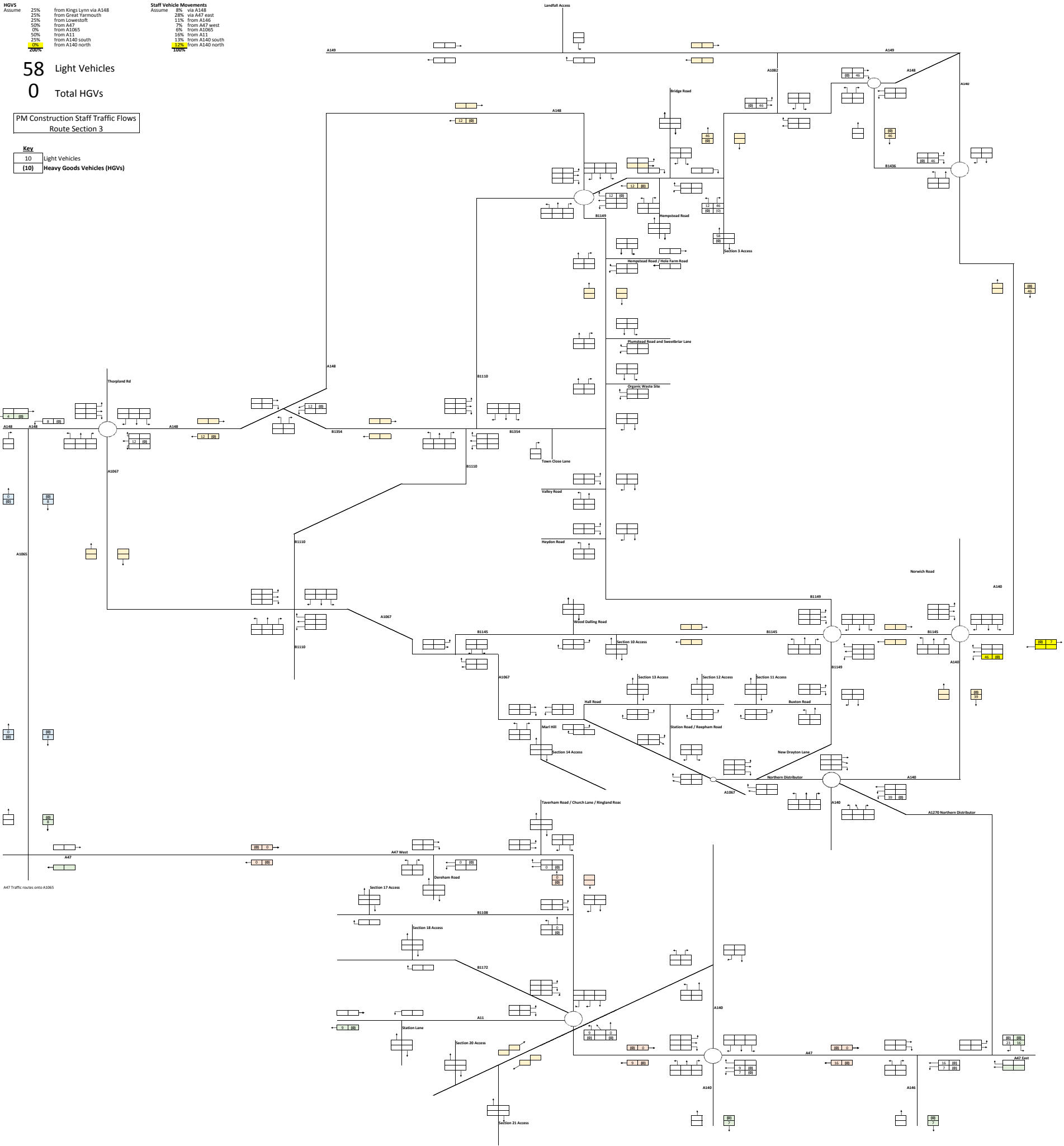

HGVS		Staff Vehicle Movements	
Assume	25%	Assume	8%
	25%		28%
	25%		11%
	50%		7%
	0%		6%
	50%		16%
	25%		13%
	25%		12%
	25%		10%

35 Light Vehicles
0 Total HGVs

PM Construction Staff Traffic Flows
Route Section 4

Key	
10	Light Vehicles
(10)	Heavy Goods Vehicles (HGVs)

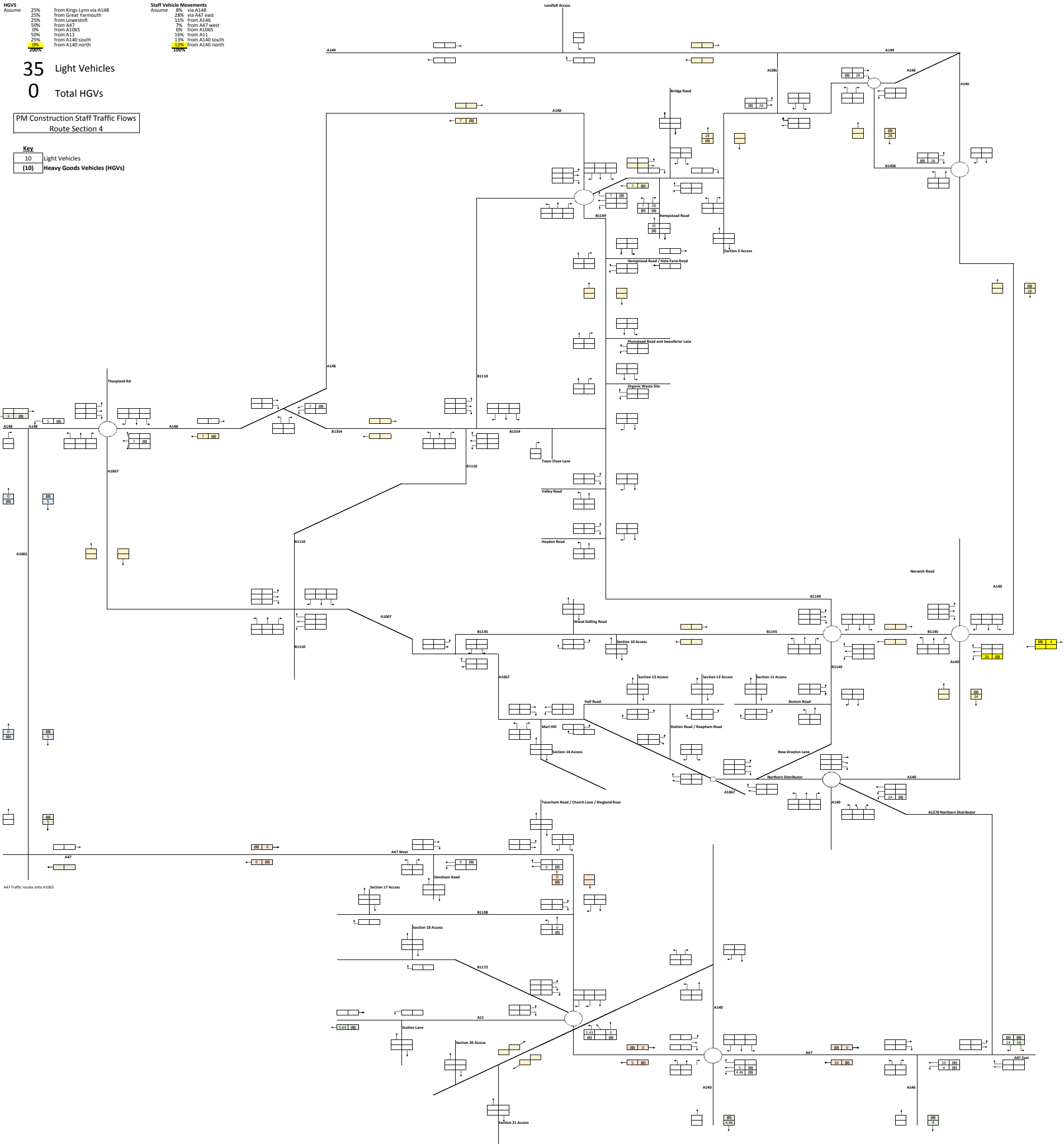

HGVS		Staff Vehicle Movements	
Assume	25%	Assume	8%
	from Kings Lynn via A148		via A148
	25%		28%
	from Great Yarmouth		via A27 east
	25%		11%
	from Lowestoft		from A146
	50%		7%
	from A27		from A27 west
	0%		6%
	from A1065		from A11
	50%		16%
	from A11		13%
	25%		from A140 south
	from A140 south		12%
	from A140 north		10%

35 Light Vehicles
0 Total HGVs

PM Construction Staff Traffic Flows
Route Section 5

Key
 10 Light Vehicles
 10 Heavy Goods Vehicles (HGVs)

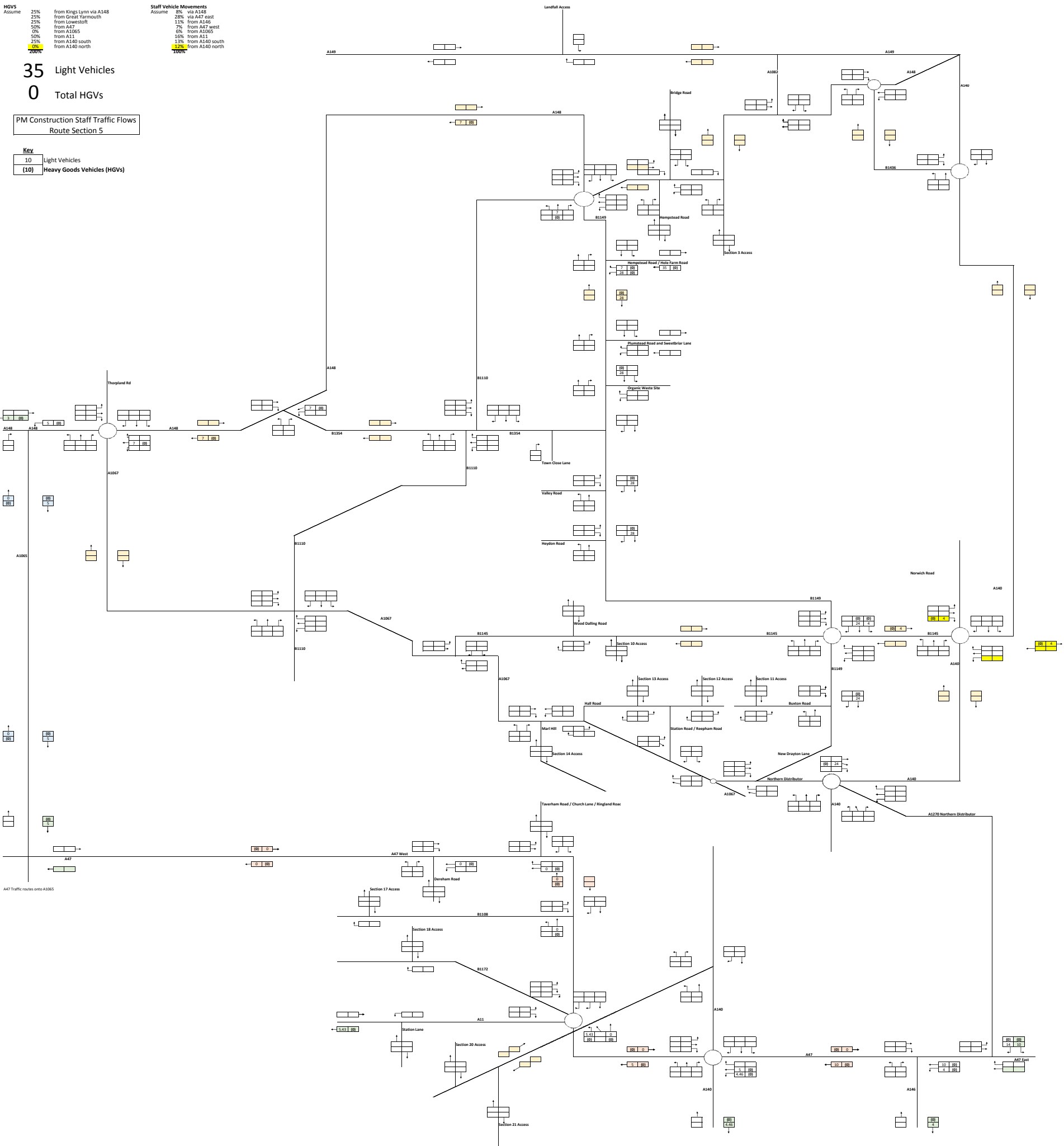

PM Construction Staff Traffic Flows
Phase 1 Total

234 Light Vehicles
0 Total HGVs
234 Total Vehicles

Key
10 Light Vehicles
10 Heavy Goods Vehicles (HGVs)

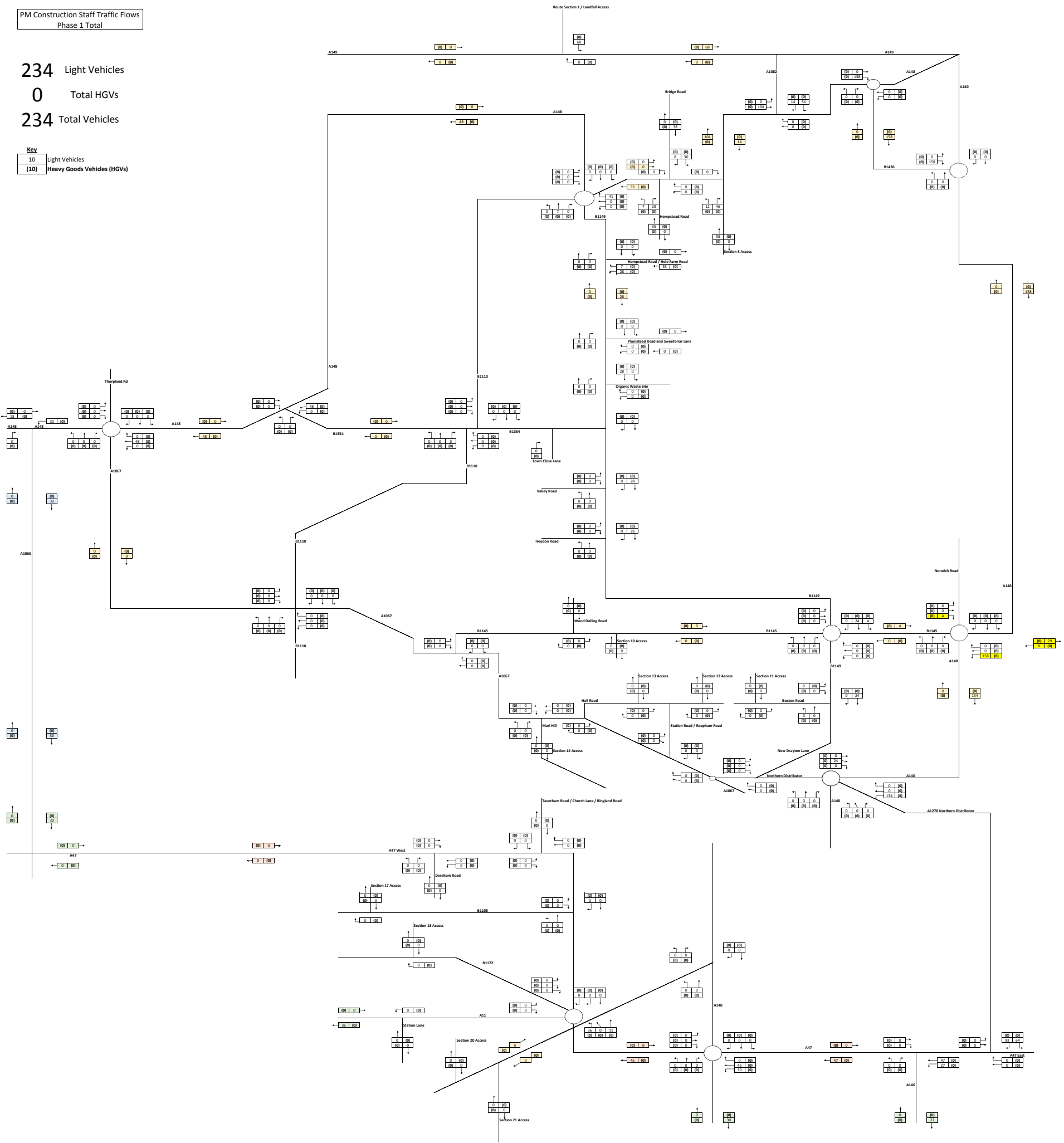

Heavy Goods Vehicle (HGV) Movements		Staff Vehicle Movements	
Assume	25%	Assume	8%
	from Kings Lynn via A148		via A148
	25%		28%
	from Great Yarmouth		via A47 east
	25%		11%
	from Lowestoft		from A146
	50%		7%
	from A47		from A47 west
	0%		6%
	from A1065		10%
	50%		from A11
	from A11		13%
	25%		from A140 south
	from A140 south		12%
	from A140 north		from A140 north
	25%		12%
	from A140 north		12%
	25%		12%

64 Light Vehicles

0 Total HGVs

PM Construction Staff Traffic Flows
Route Section 6

Key	
10	Light Vehicles
(10)	Heavy Goods Vehicles (HGVs)

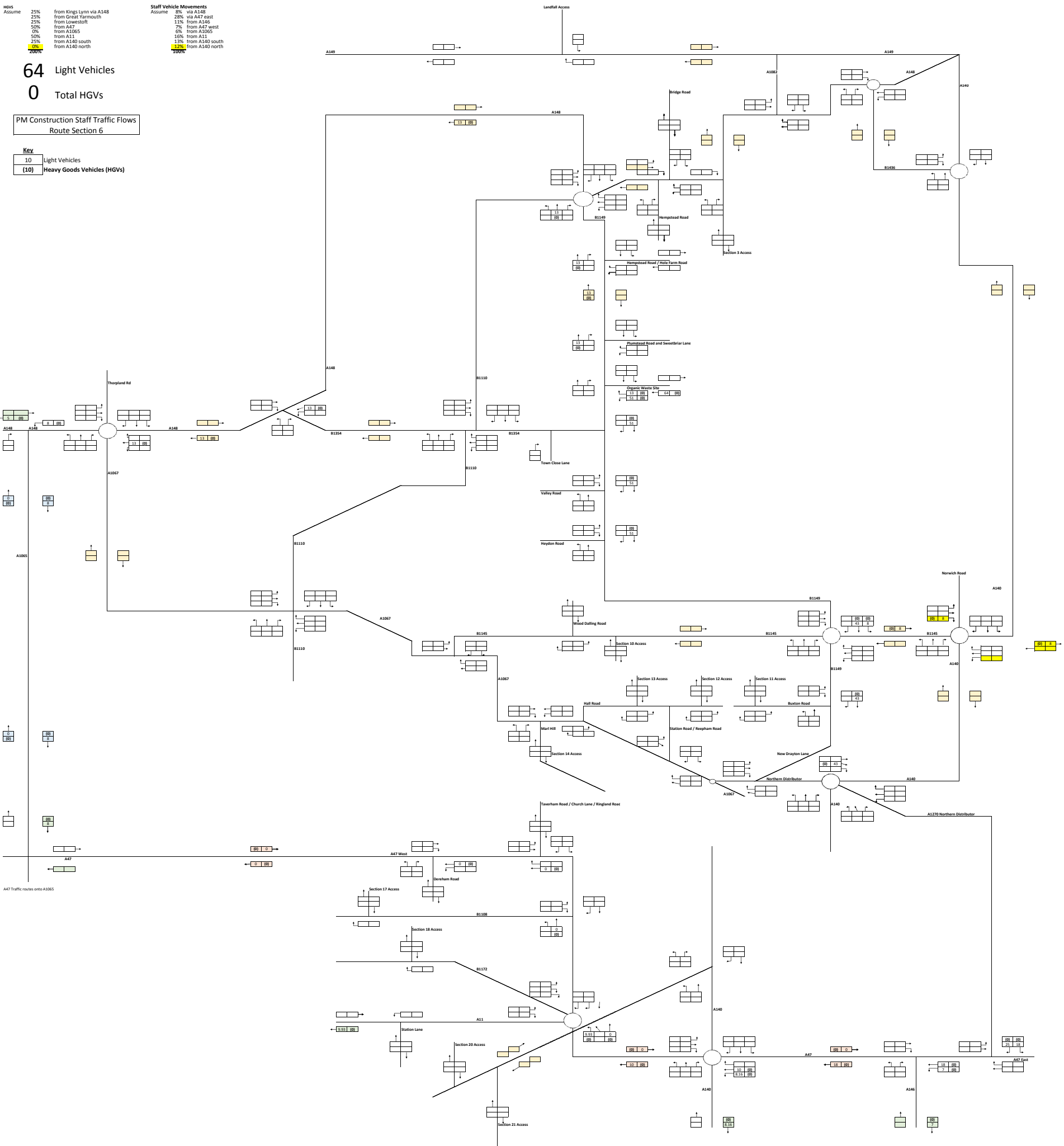

HGVs	25%	from Kings Lynn via A148	Staff Vehicle Movements	28%	via A148
Assume	25%	from Great Yarmouth	Assume	11%	from A146
	25%	from Lowestoft		7%	from A147 west
	50%	from A47		6%	from A105
	0%	from A105		10%	from A11
	50%	from A140 south		13%	from A140 south
	25%	from A140 north		12%	from A140 north
	25%	from A140 north		10%	from A140 north

83 Light Vehicles

0 Total HGVs

PM Construction Staff Traffic Flows
Route Section 8

Key	
10	Light Vehicles
(10)	Heavy Goods Vehicles (HGVs)

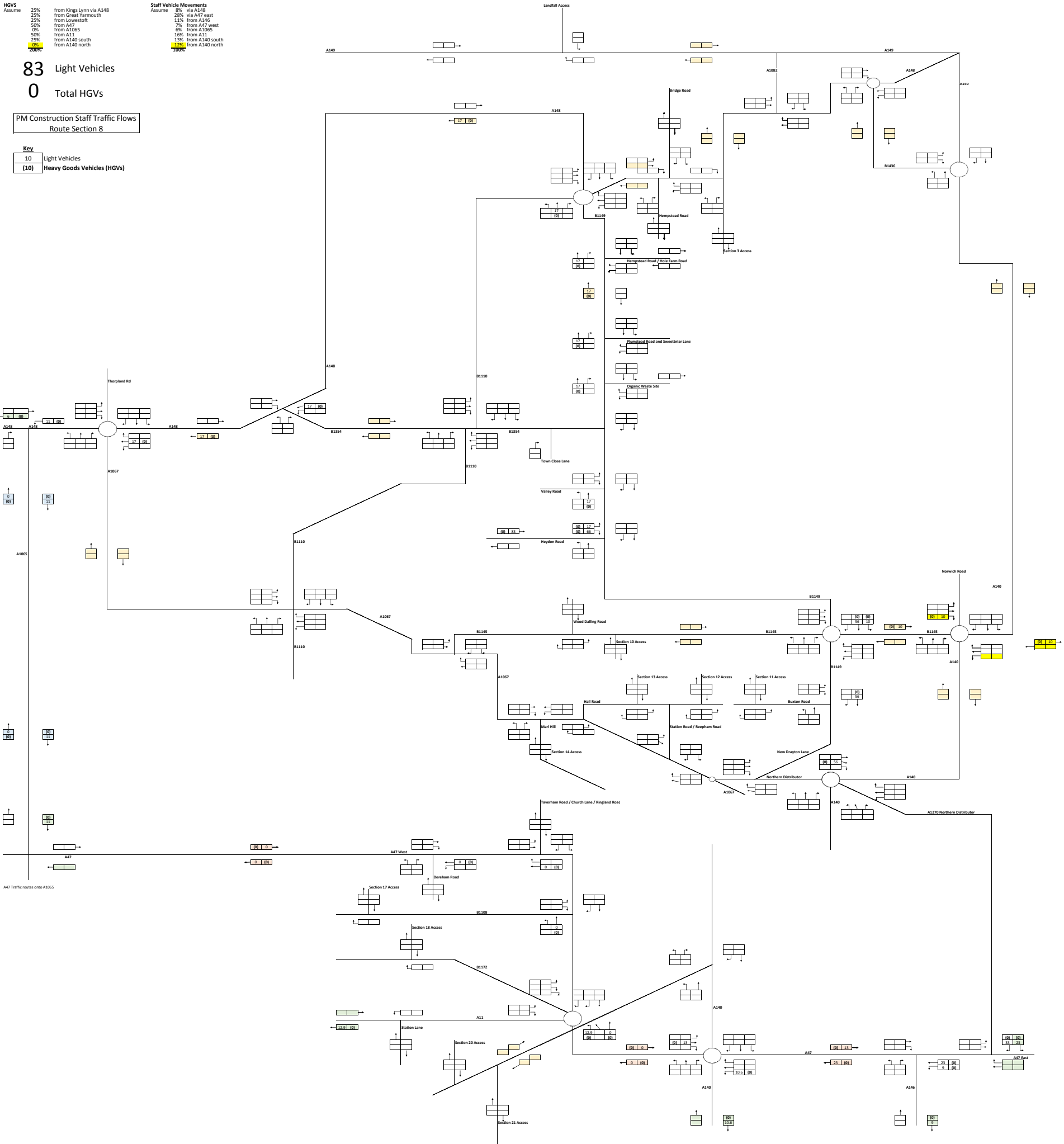

HGVS		Staff Vehicle Movements	
Assume	25%	Assume	8%
	25%		28%
	25%		11%
	50%		7%
	0%		6%
	50%		16%
	25%		13%
	25%		12%
	25%		12%

64 Light Vehicles

0 Total HGVs

PM Construction Staff Traffic Flows
Route Section 9

Key	
10	Light Vehicles
(10)	Heavy Goods Vehicles (HGVs)

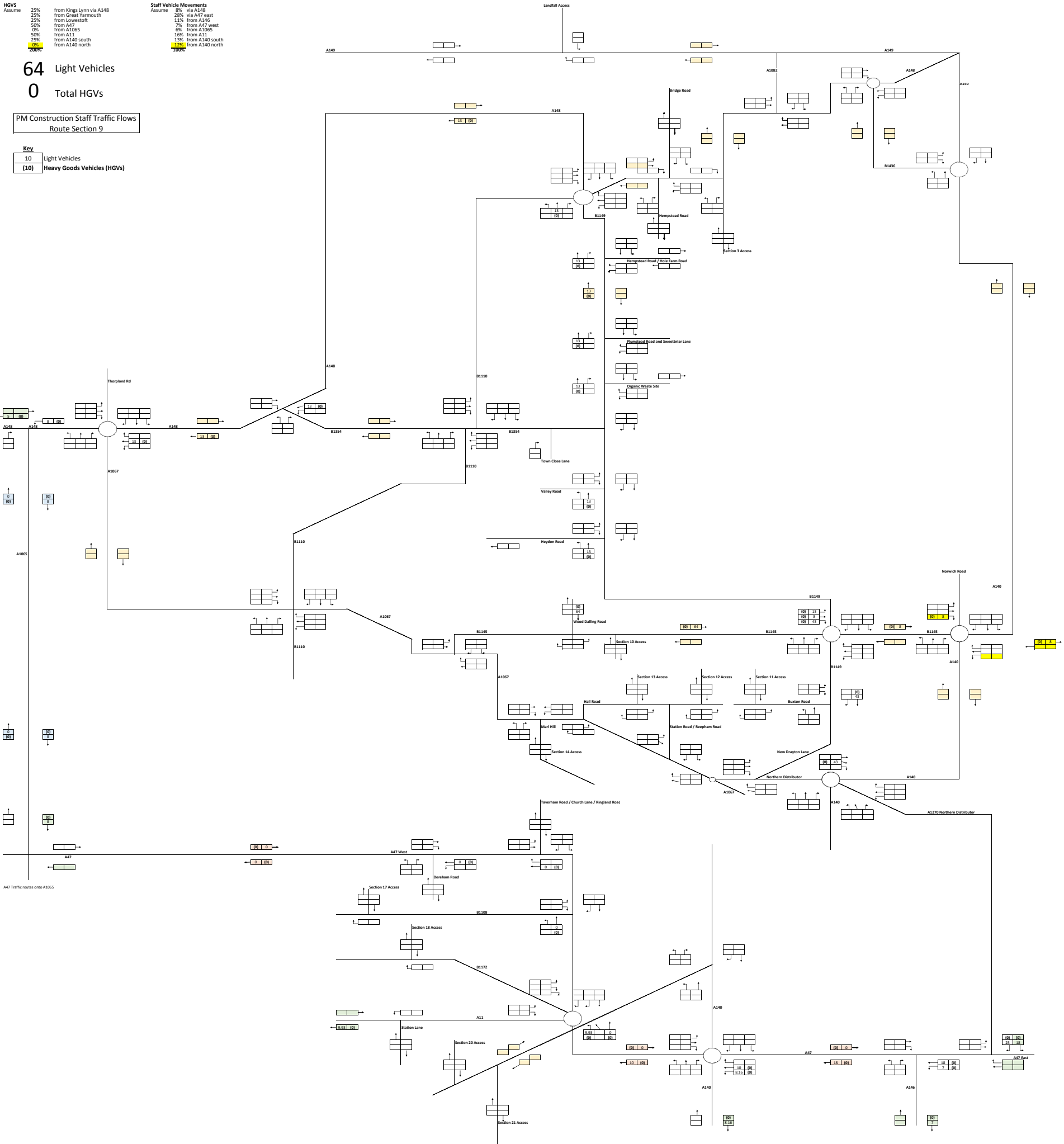

HGVs	25%	from Kings Lynn via A148	Staff Vehicle Movements	28%	via A148
Assume	25%	from Great Yarmouth	Assume	11%	from A146
	25%	from Lowestoft		7%	from A147 west
	50%	from A47		6%	from A105
	0%	from A105		10%	from A11
	50%	from A140 south		13%	from A140 south
	25%	from A140 north		12%	from A140 north
	25%	from A140 north		10%	from A140 north

58 Light Vehicles
0 Total HGVs

PM Construction Staff Traffic Flows
Route Section 10

Key	
10	Light Vehicles
(10)	Heavy Goods Vehicles (HGVs)

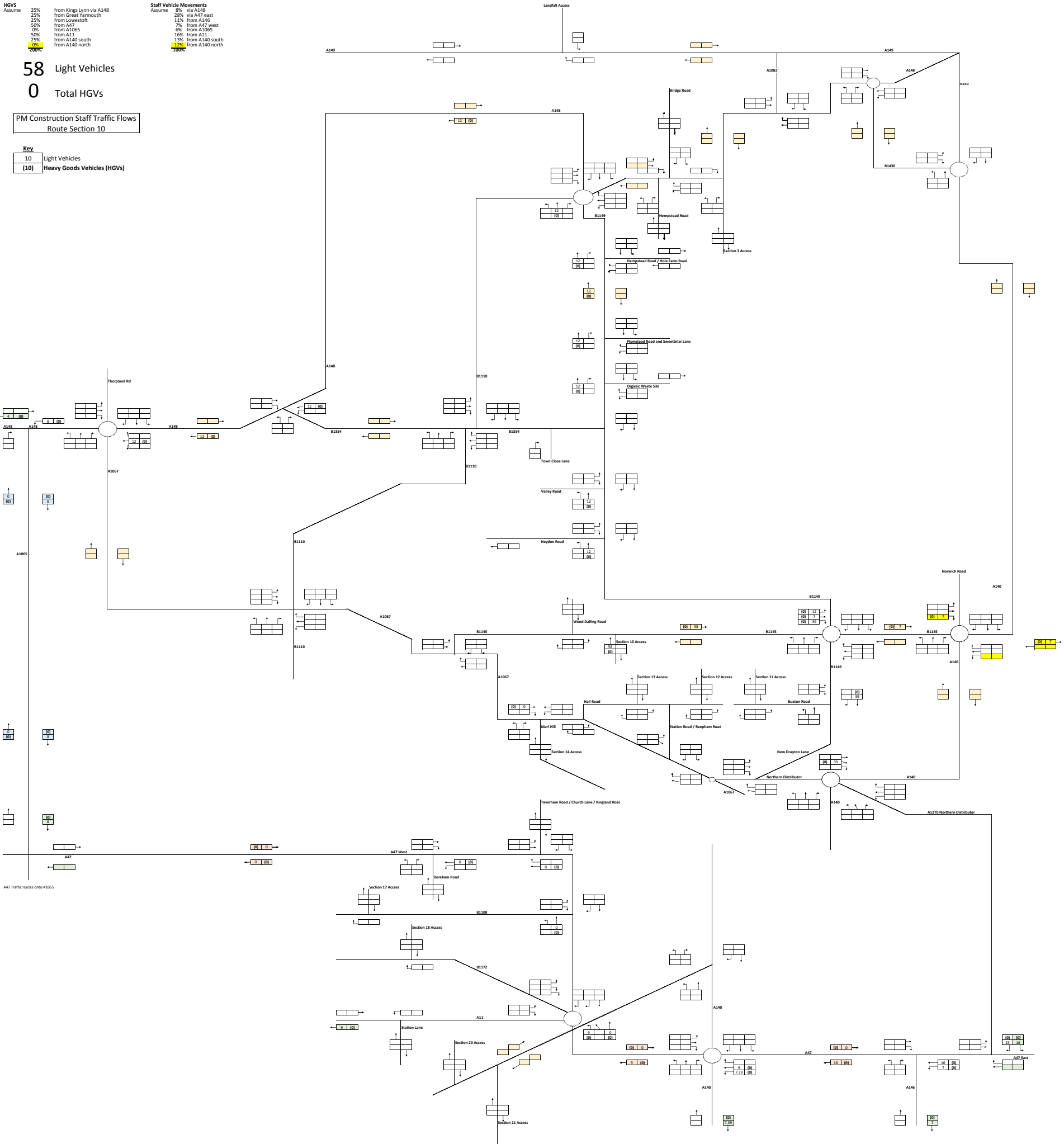

HGVs	25%	from Kings Lynn via A148	Staff Vehicle Movements	28%	via A148
Assume	25%	from Great Yarmouth	Assume	11%	from A146
	25%	from Lowestoft		7%	from A147 west
	50%	from A47		6%	from A105
	0%	from A105		10%	from A11
	50%	from A140 south		13%	from A140 south
	25%	from A140 north		12%	from A140 north
	25%	from A140 north		10%	from A140 north

48 Light Vehicles

0 Total HGVs

PM Construction Staff Traffic Flows
Route Section 11

Key	
10	Light Vehicles
(10)	Heavy Goods Vehicles (HGVs)

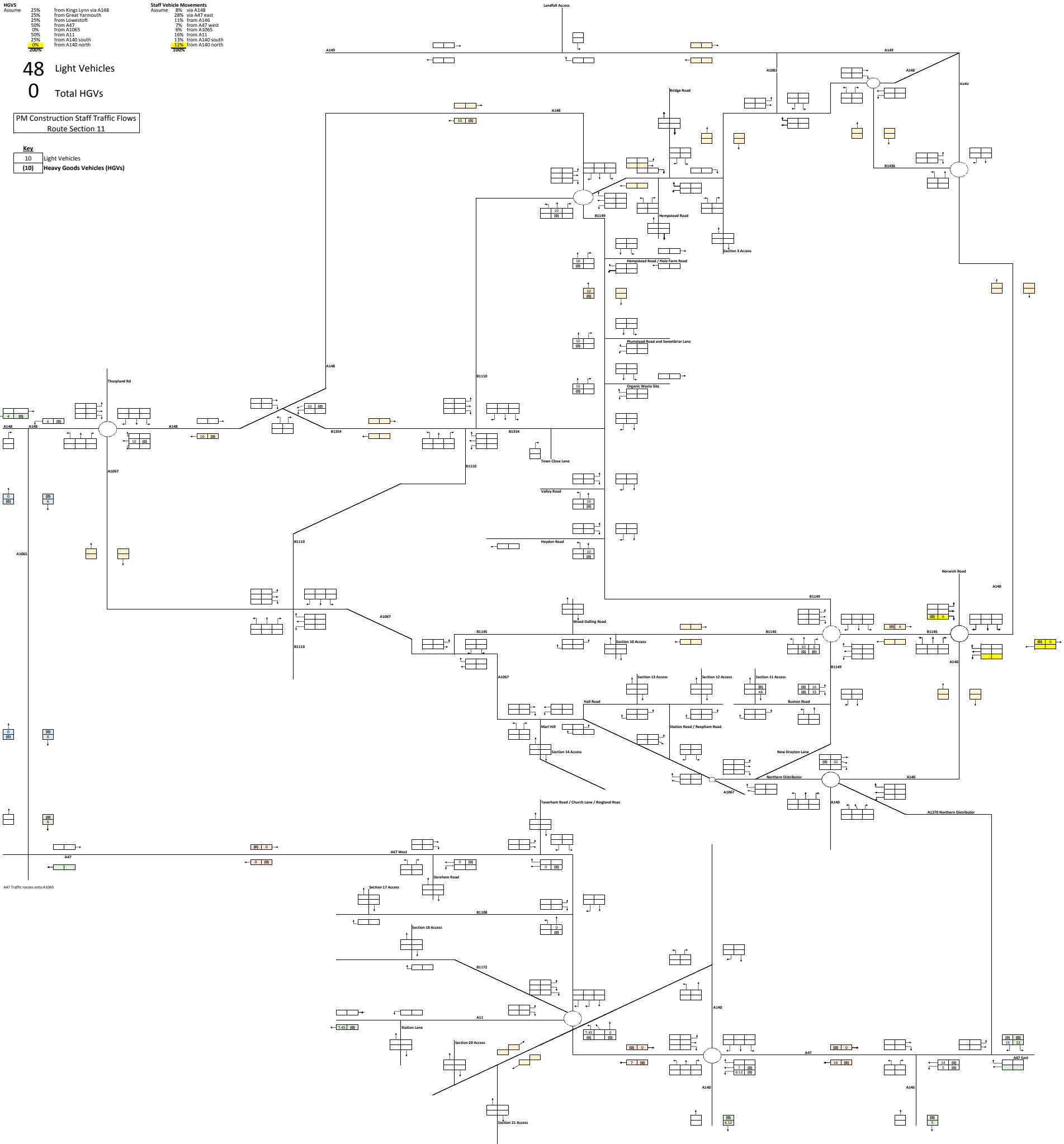

PM Construction Staff Traffic Flows
Phase 2 Total

317 Light Vehicles

0 Total HGVs

317 Total Vehicles

Key	
10	Light Vehicles
10	Heavy Goods Vehicles (HGVs)

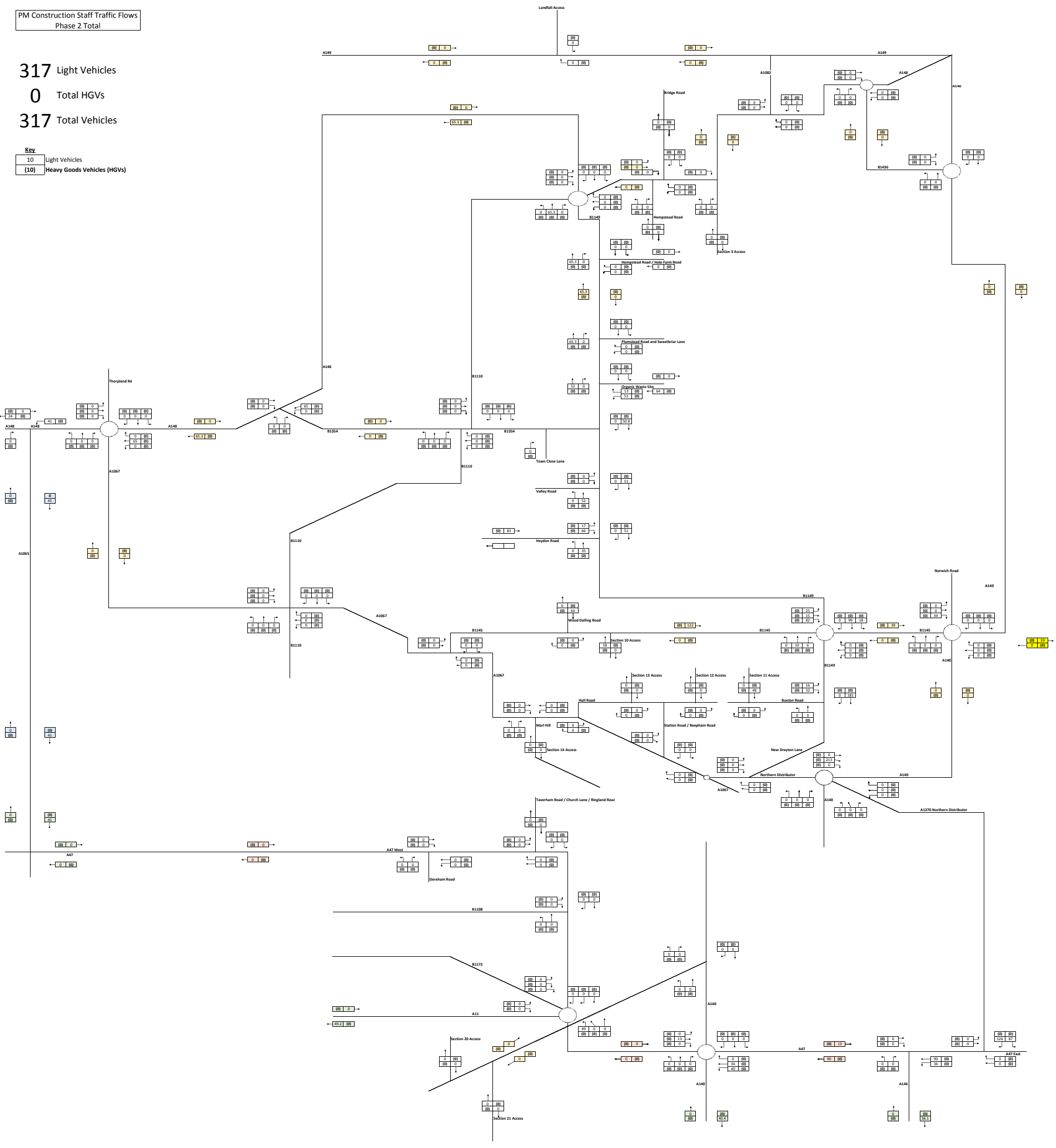

HGVs	Assume	25%	from Kings Lynn via A148
	Assume	25%	from Great Yarmouth
	Assume	25%	from Lowestoft
	Assume	50%	from A47
	Assume	0%	from A1065
	Assume	50%	from A11
	Assume	25%	from A140 south
	Assume	25%	from A140 north
	Assume	25%	from A140 north
	Assume	25%	from A140 north

Staff Vehicle Movements	Assume	8%	via A148
	Assume	28%	via A47 east
	Assume	11%	from A146
	Assume	7%	from A47 west
	Assume	6%	from A1065
	Assume	16%	from A11
	Assume	13%	from A140 south
	Assume	12%	from A140 north
	Assume	12%	from A140 north

35 Light Vehicles
0 Total HGVs

PM Construction Staff Traffic Flows
Route Section 12

Key	
10	Light Vehicles
(10)	Heavy Goods Vehicles (HGVs)

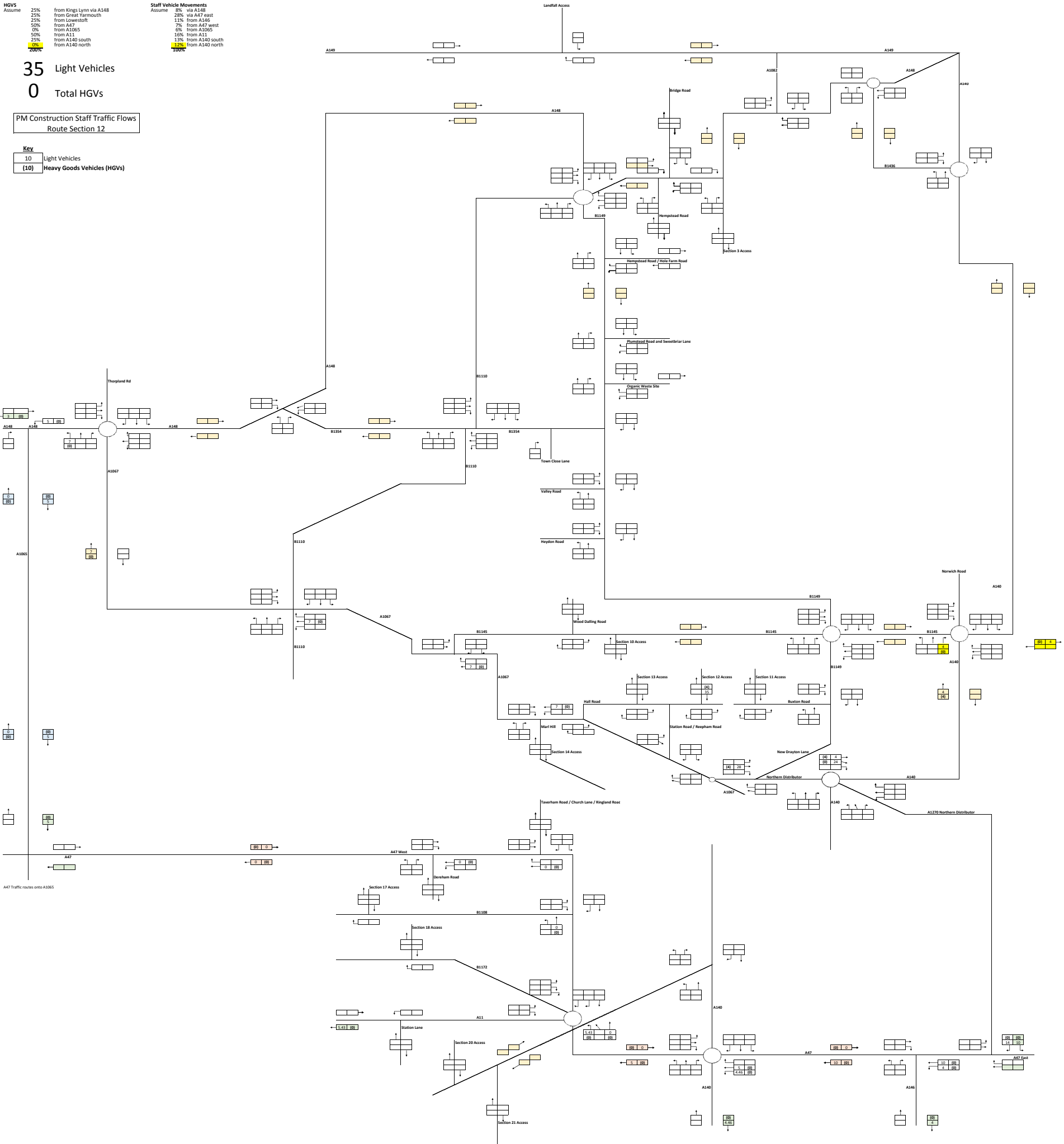

A47 Traffic routes onto A1065

HGVs	25%	from Kings Lynn via A148	Staff Vehicle Movements	28%	via A148
Assume	25%	from Great Yarmouth	Assume	11%	from A146
	25%	from Lowestoft		7%	from A147 west
	50%	from A47		6%	from A105
	0%	from A105		10%	from A11
	50%	from A140 south		13%	from A140 south
	25%	from A140 north		12%	from A140 north
	25%	from A140 north		10%	from A140 north

48 Light Vehicles

0 Total HGVs

PM Construction Staff Traffic Flows
Route Section 13

Key	
10	Light Vehicles
(10)	Heavy Goods Vehicles (HGVs)

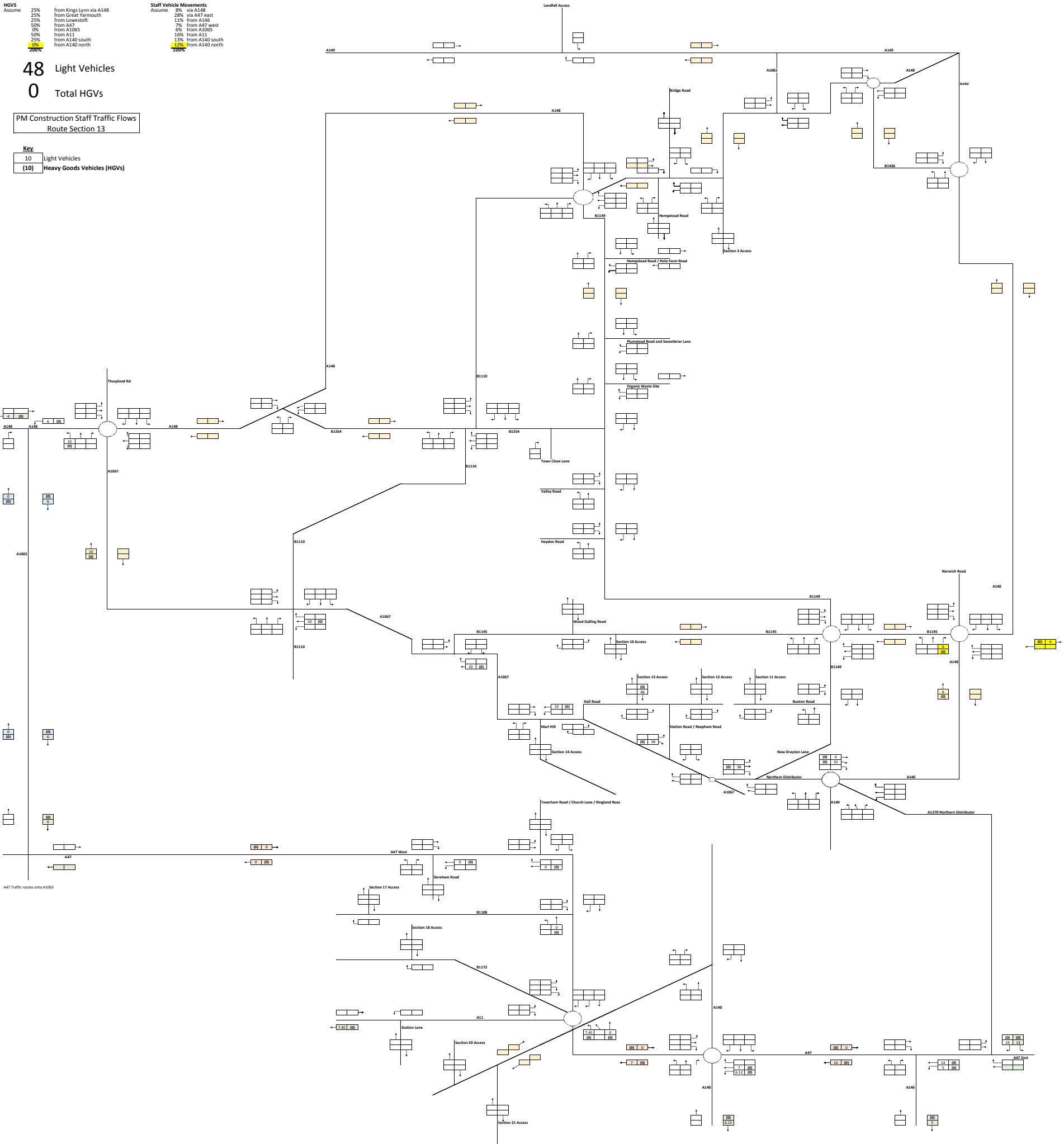

HGVs	25%	from Kings Lynn via A148	Staff Vehicle Movements	28%	via A148
Assume	25%	from Great Yarmouth	Assume	11%	from A146
	25%	from Lowestoft		7%	from A47 west
	50%	from A47		6%	from A105
	0%	from A105		10%	from A11
	50%	from A11		13%	from A140 south
	25%	from A140 south		12%	from A140 north
	25%	from A140 north		10%	from A140 north

97 Light Vehicles

0 Total HGVs

PM Construction Staff Traffic Flows
Route Section 14

Key	
10	Light Vehicles
(10)	Heavy Goods Vehicles (HGVs)

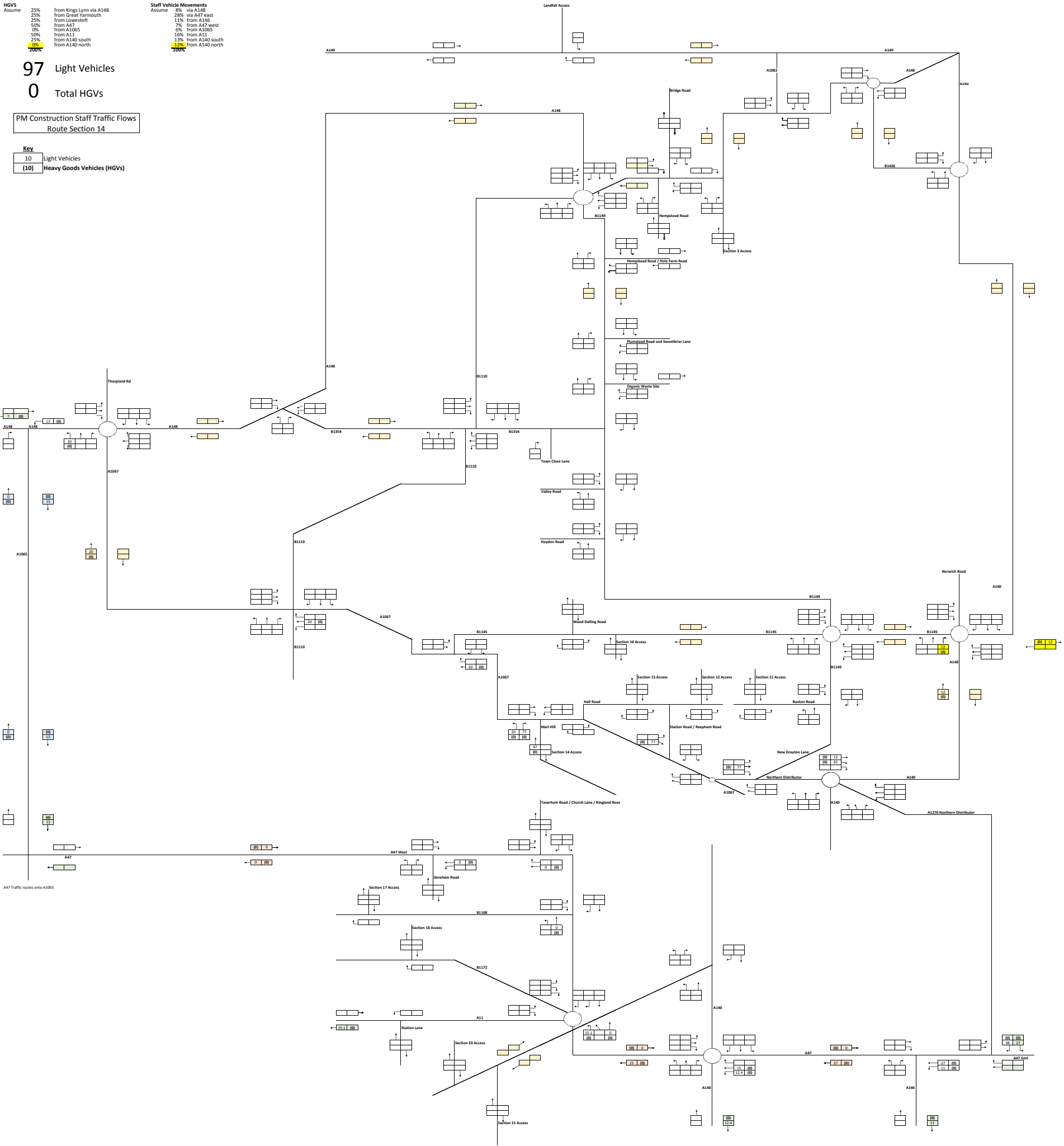

HGVS		Staff Vehicle Movements	
Assume	25%	Assume	8%
	25%		28%
	25%		11%
	50%		7%
	0%		6%
	50%		10%
	25%		13%
	25%		12%
	25%		12%

42 Light Vehicles
0 Total HGVs

PM Construction Staff Traffic Flows
Route Section 15

Key	
10	Light Vehicles
(10)	Heavy Goods Vehicles (HGVs)

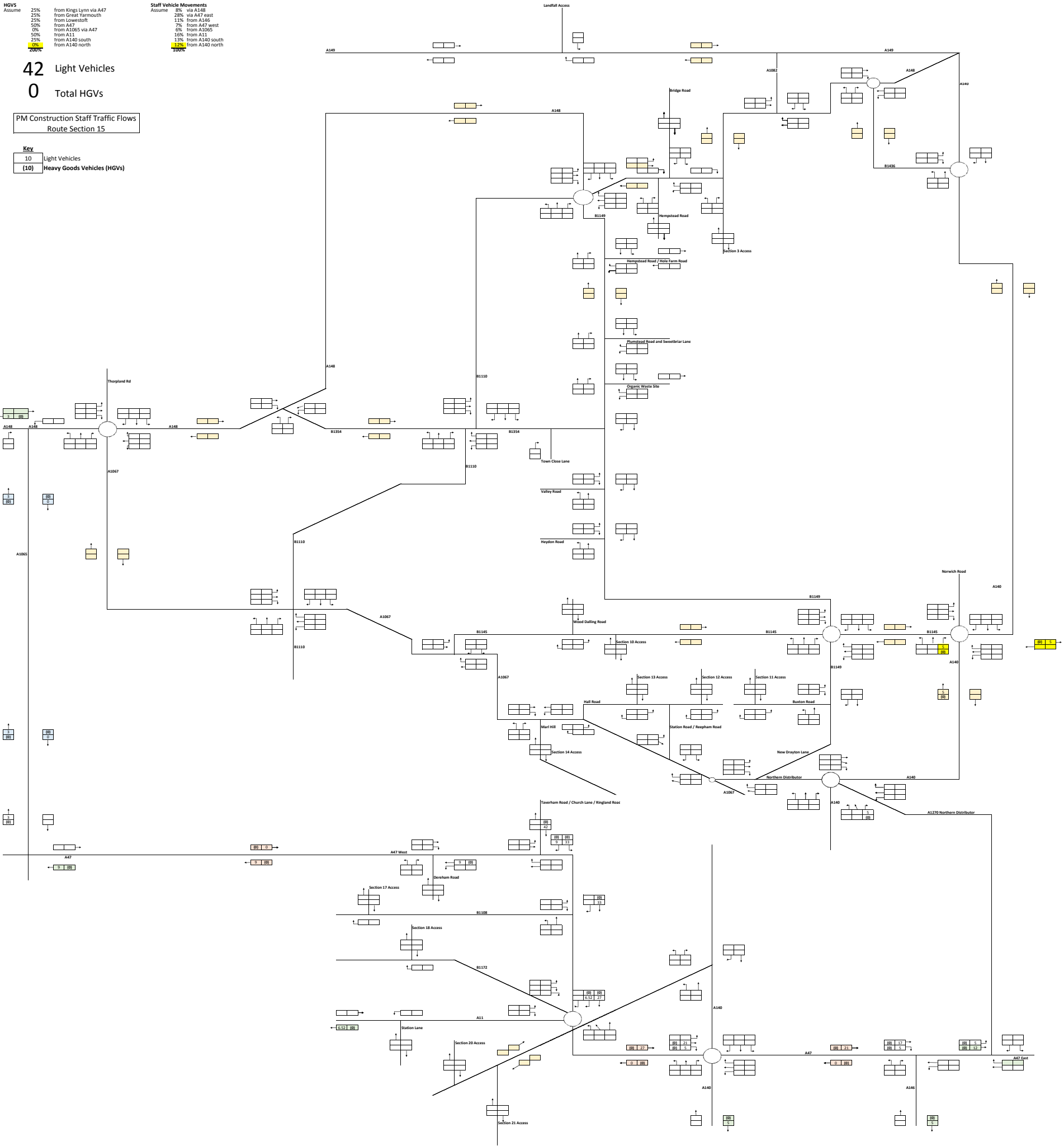

HGVs Assume	
25%	from Kings Lynn via A47
25%	from Great Yarmouth
25%	from Lowestoft
50%	from A47
0%	from A1005 via A47
50%	from A11
25%	from A140 south
25%	from A140 north

Staff Vehicle Movements Assume	
8%	via A140
28%	via A47 east
11%	from A140
7%	from A47 west
6%	from A1005
10%	from A11
13%	from A140 south
12%	from A140 north

64 Light Vehicles
0 Total HGVs

PM Construction Staff Traffic Flows
Route Section 16

Key	
10	Light Vehicles
(10)	Heavy Goods Vehicles (HGVs)

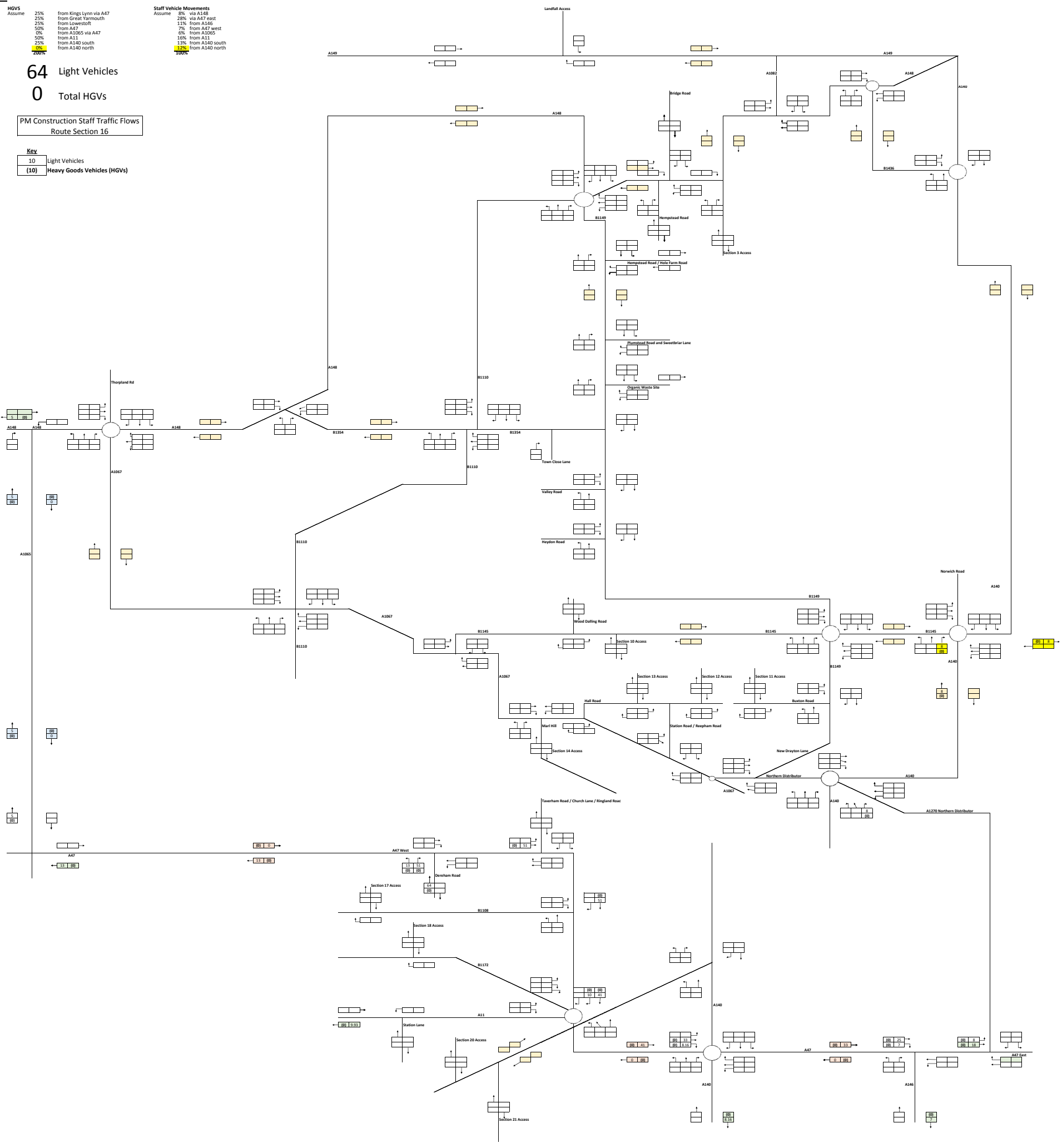

PM Construction Staff Traffic Flows
Phase 3 Total

286 Light Vehicles

0 Total HGVs

286 Total Vehicles

Key
10 Light Vehicles
(10) Heavy Goods Vehicles (HGVs)

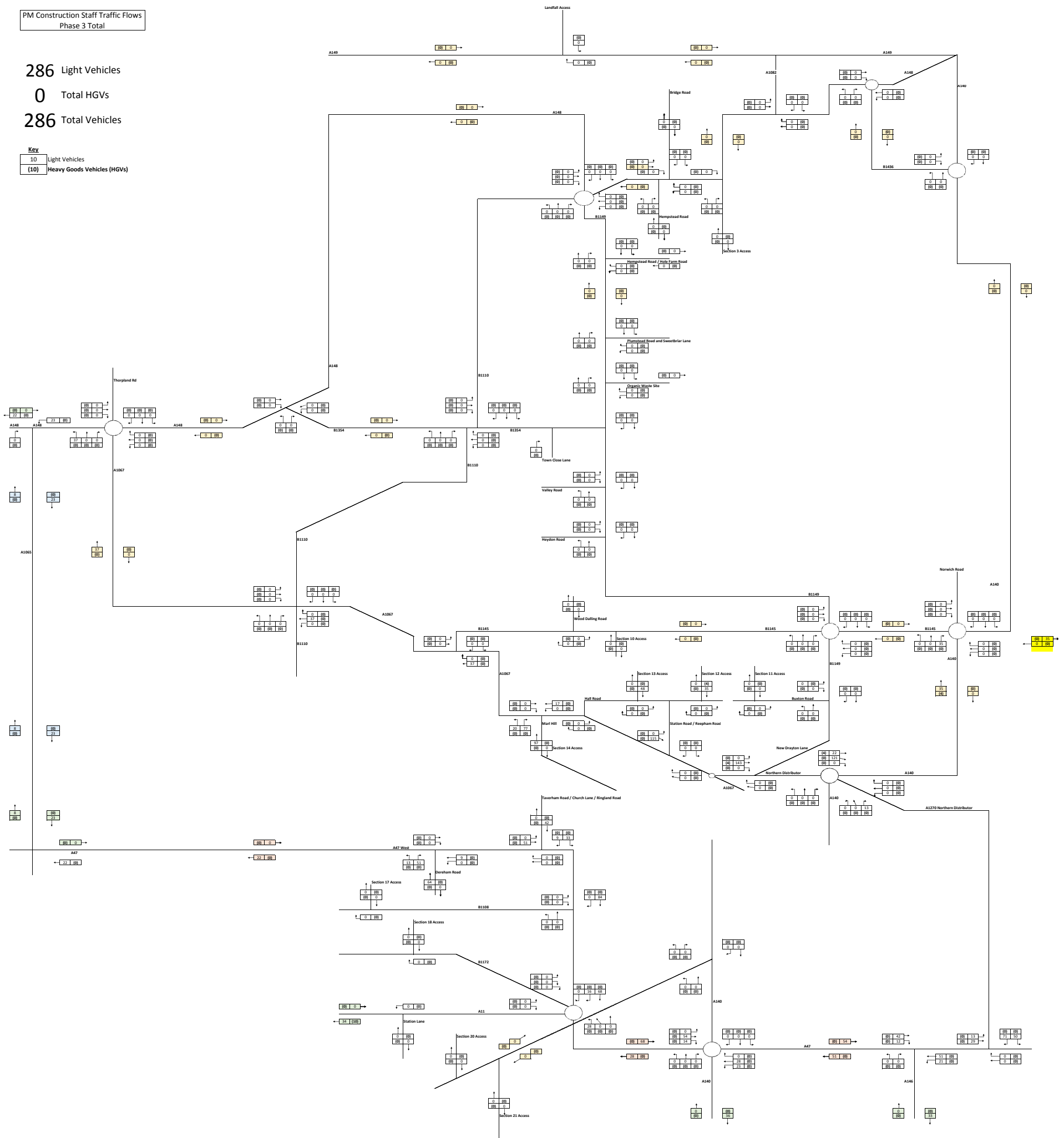

HGVs	25%	from Kings Lynn via A47	Staff Vehicle Movements	28%	via A148
Assume	25%	from Great Yarmouth	Assume	11%	from A146
	25%	from Lowestoft		7%	from A47 west
	50%	from A47		6%	from A1065
	0%	from A1065 via A47		10%	from A11
	50%	from A11		13%	from A140 south
	25%	from A140 south		12%	from A140 north
	25%	from A140 north		12%	from A140 north
	25%			12%	

68 Light Vehicles
0 Total HGVs

PM Construction Staff Traffic Flows
 Route Section 17

Key
10 Light Vehicles
(10) Heavy Goods Vehicles (HGVs)

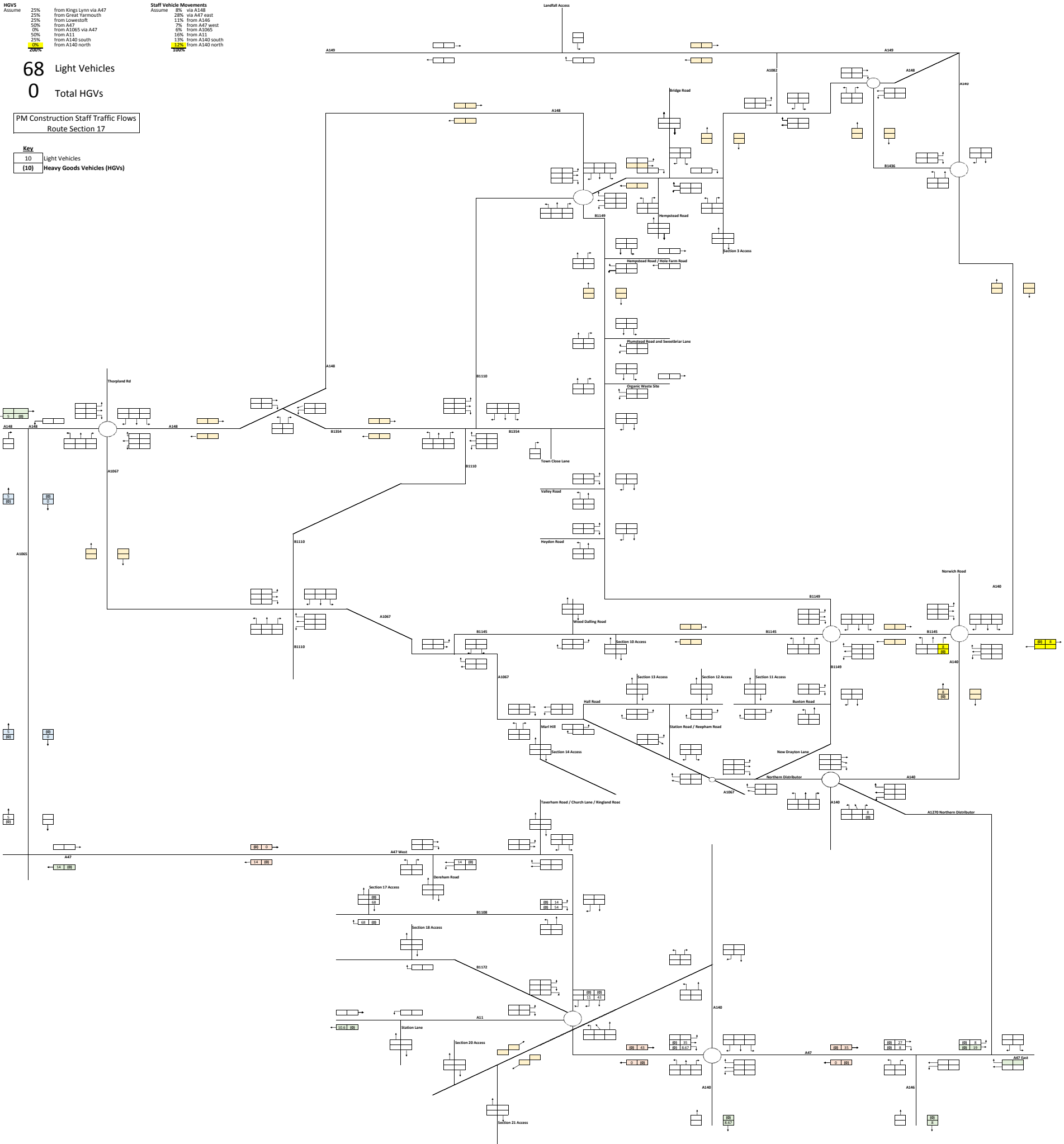

HGVs		Staff Vehicle Movements	
Assume	25%	Assume	30%
	from Kings Lynn via A47		via A148
	25%		28%
	from Great Yarmouth		via A47 east
	25%		11%
	from Lowestoft		from A146
	50%		7%
	from A47		from A47 west
	0%		6%
	from A1065 via A47		10%
	50%		from A11
	0%		13%
	from A11		from A140 south
	25%		12%
	from A140 south		from A140 north
	25%		12%
	from A140 north		12%
	25%		12%

116 Light Vehicles

0 Total HGVs

PM Construction Staff Traffic Flows
Route Section 18

Key	
10	Light Vehicles
(10)	Heavy Goods Vehicles (HGVs)

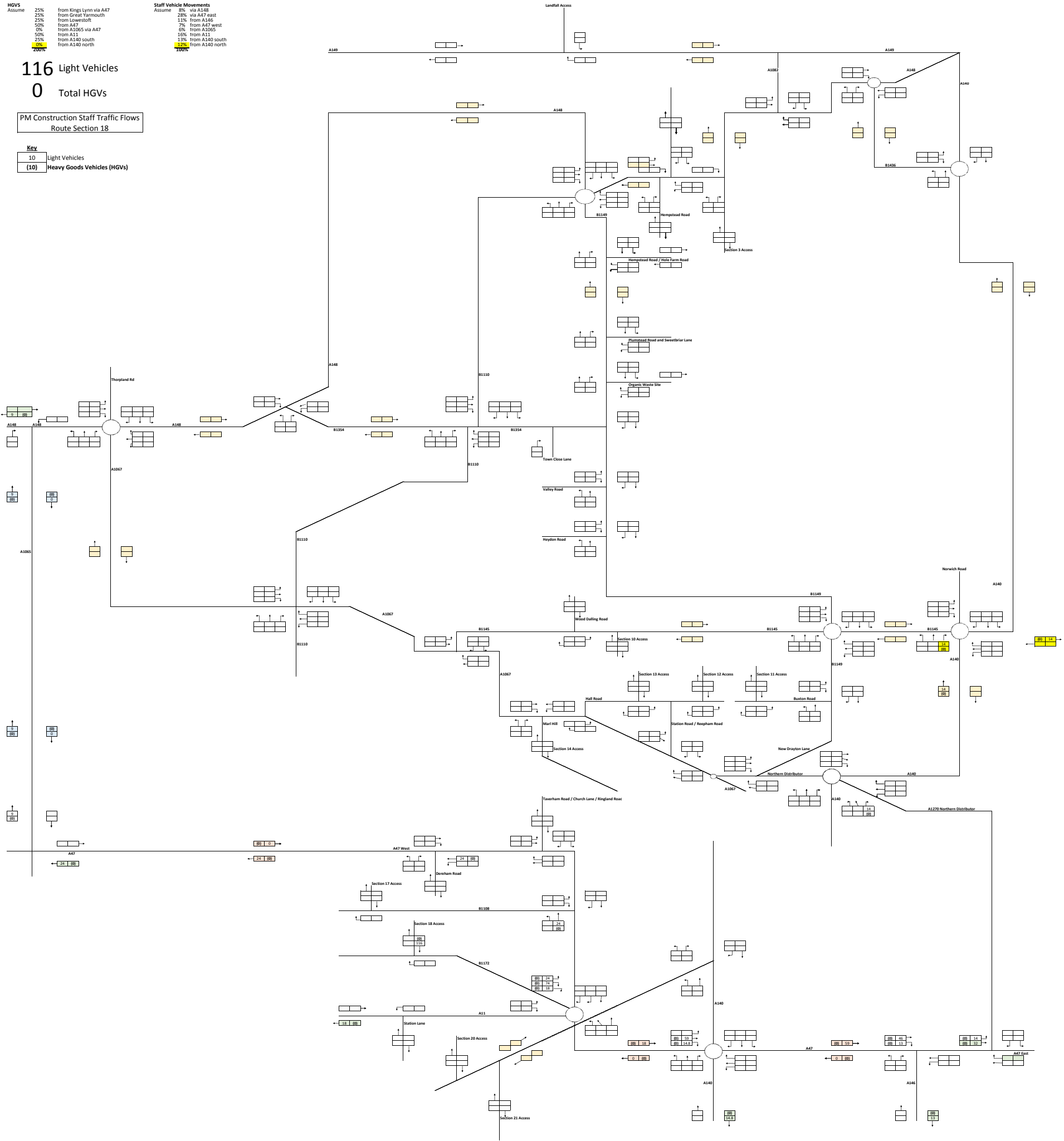

HGVs		Staff Vehicle Movements	
Assume	25%	Assume	8%
	from Kings Lynn via A47		via A148
	25%		28%
	from Great Yarmouth		via A47 east
	25%		11%
	from Lowestoft		from A146
	50%		7%
	from A47		from A47 west
	0%		6%
	from A1065 via A47		from A11
	50%		10%
	from A11		13%
	25%		from A140 south
	from A140 south		12%
	from A140 north		10%
	25%		from A140 north
	25%		10%

54 Light Vehicles

0 Total HGVs

PM Construction Staff Traffic Flows
Route Section 19

Key	
10	Light Vehicles
10	Heavy Goods Vehicles (HGVs)

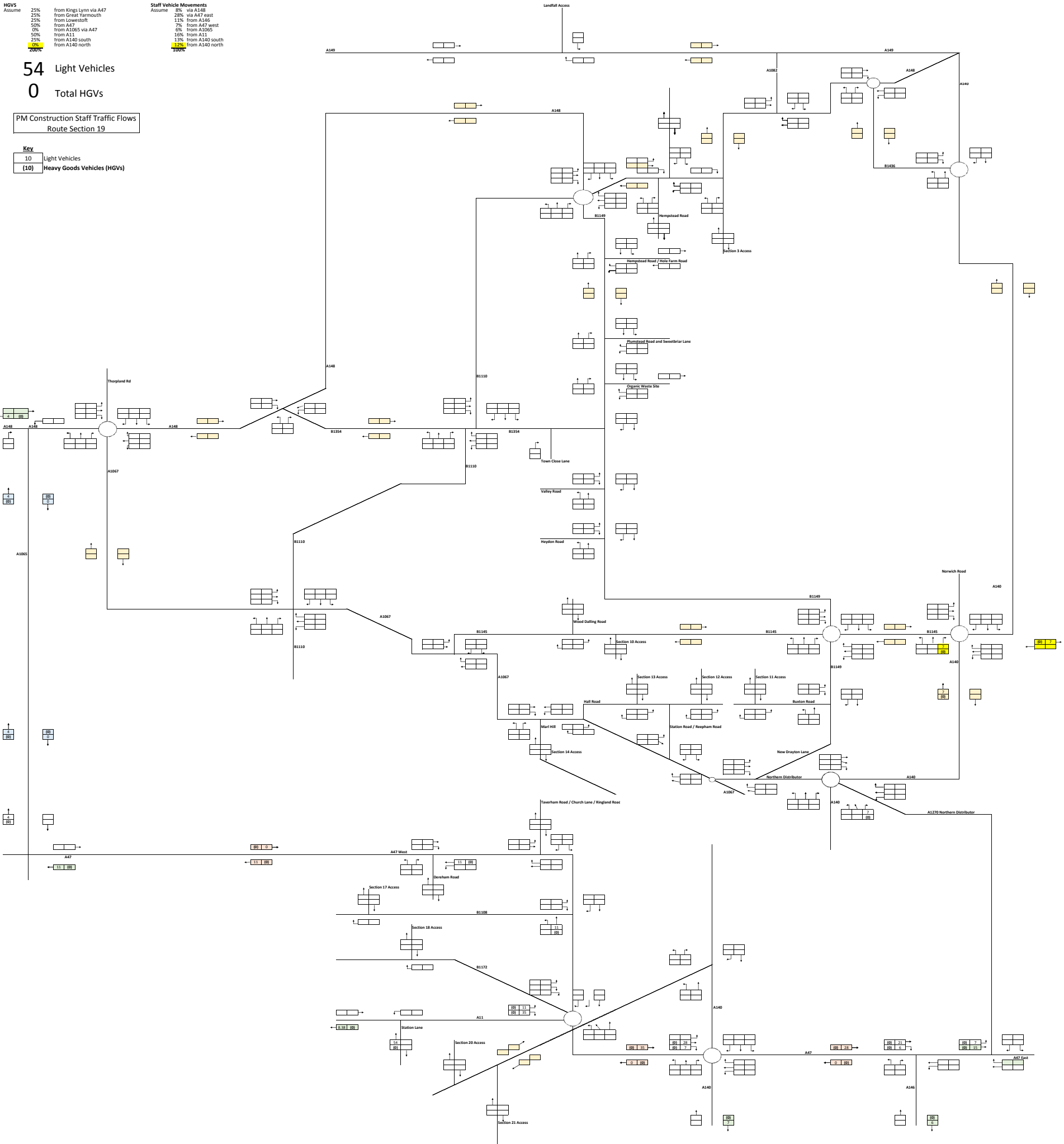

HGVs		Staff Vehicle Movements	
Assume	25%	Assume	28%
	25%		13%
	25%		7%
	50%		6%
	0%		10%
	25%		13%
	25%		12%
	25%		12%

54 Light Vehicles
0 Total HGVs

PM Construction Staff Traffic Flows
Route Section 20

Key	
10	Light Vehicles
(10)	Heavy Goods Vehicles (HGVs)

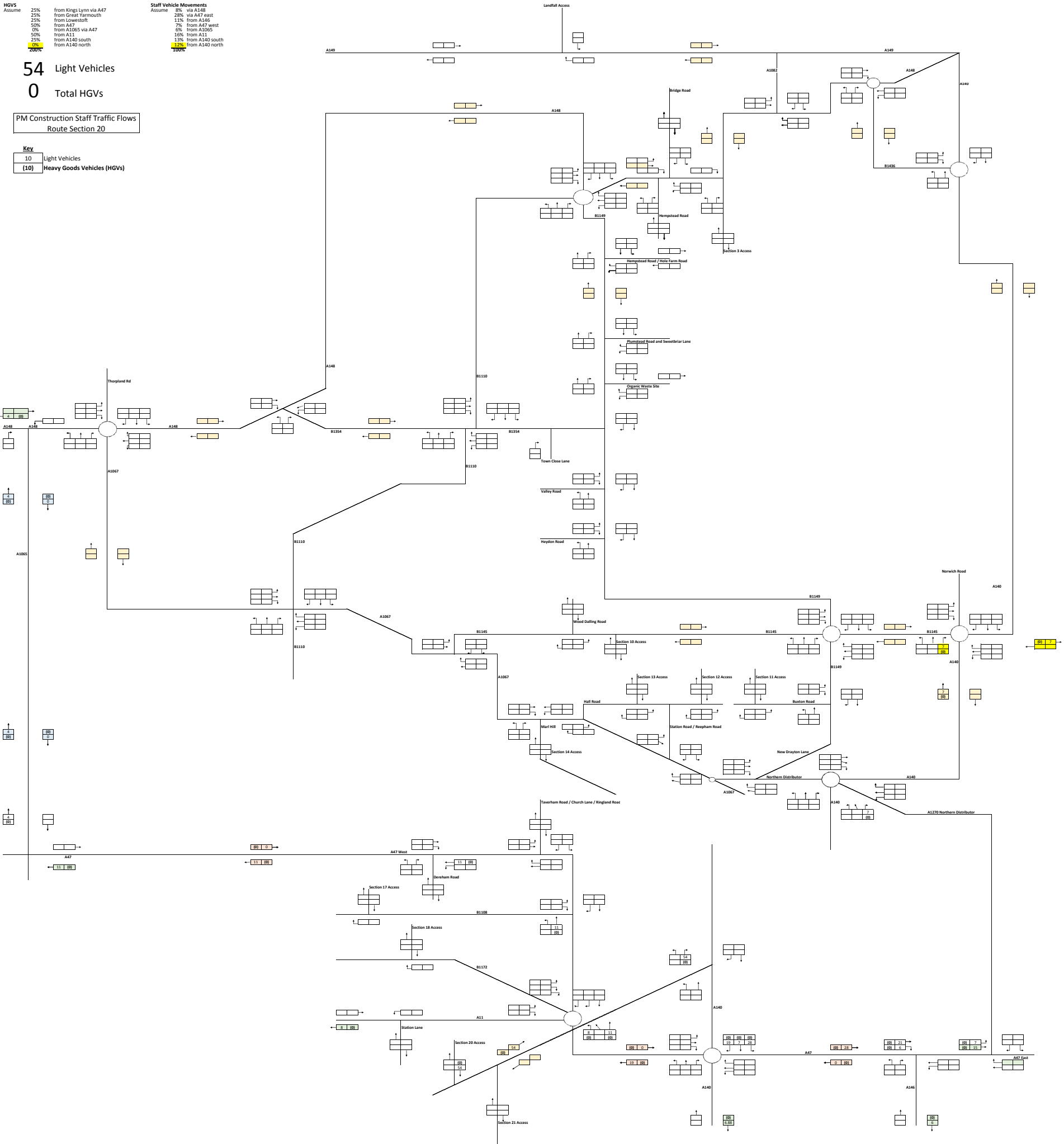

HGVS		Staff Vehicle Movements	
Assume	25%	Assume	28%
	25%		11%
	25%		7%
	50%		6%
	0%		10%
	25%		13%
	25%		12%
	25%		12%

64 Light Vehicles

0 Total HGVs

PM Construction Staff Traffic Flows
Route Section 21

Key	
10	Light Vehicles
(10)	Heavy Goods Vehicles (HGVs)

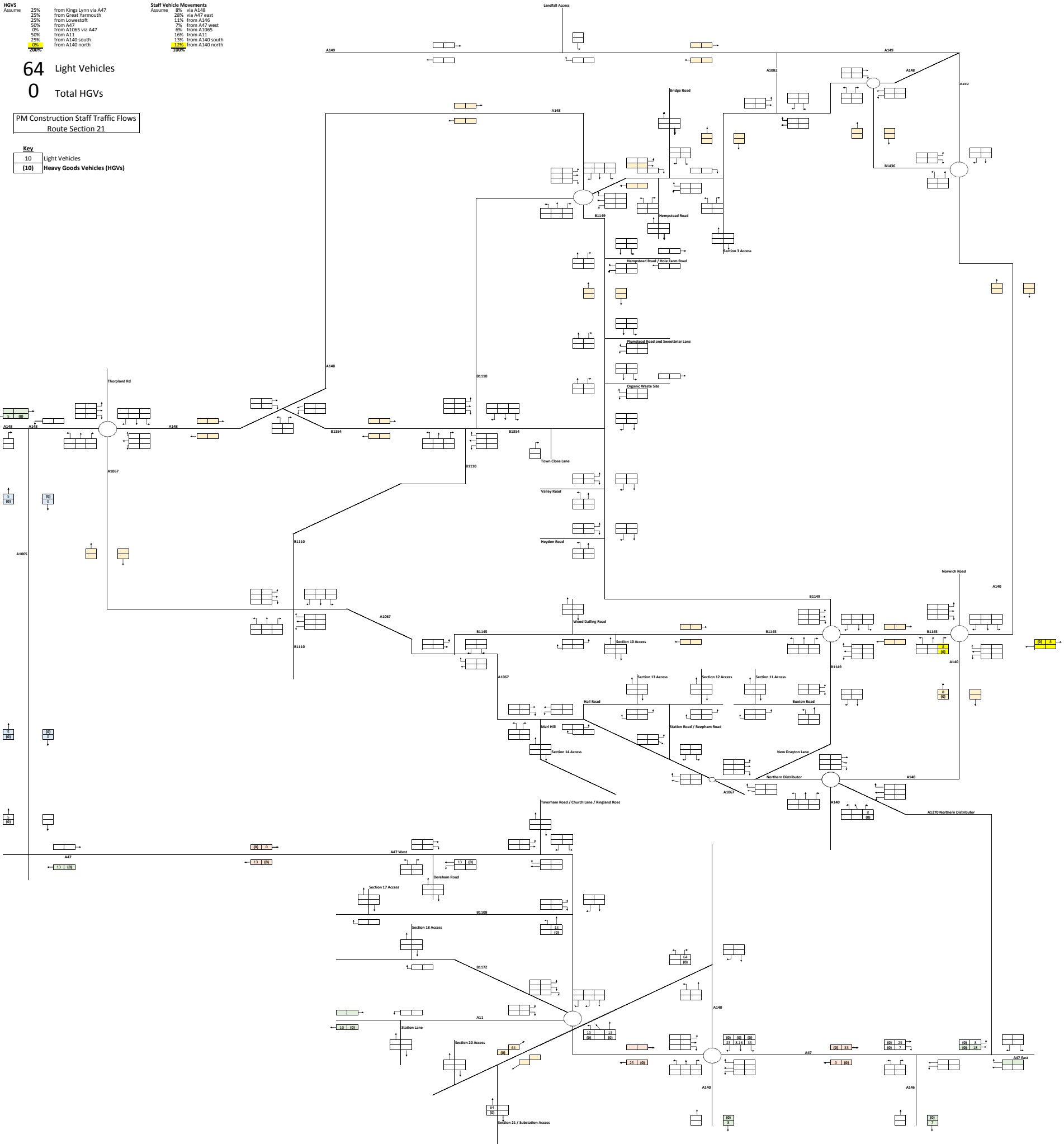

PM Construction Staff Traffic Flows
Phase 4 Total

356 Light Vehicles

0 Total HGVs

356 Total Vehicles

Key
 10 Light Vehicles
 (10) Heavy Goods Vehicles (HGVs)

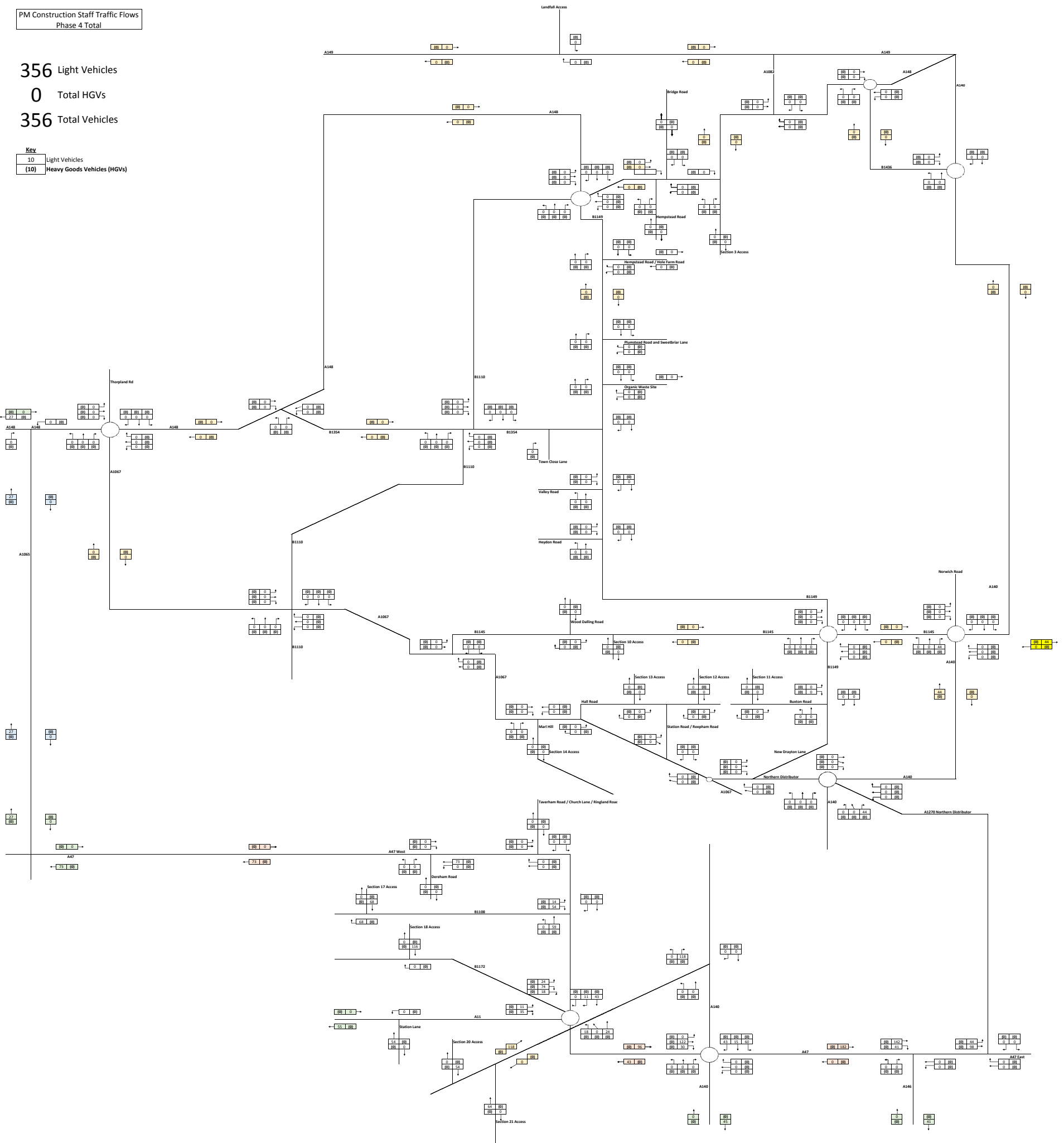

HGVs	Assume	25%	from Kings Lynn via A148
		25%	from Great Yarmouth
		25%	from Lowestoft
		50%	from A47
		0%	from A1065
		50%	from A11
		25%	from A140 south
		25%	from A140 north
		25%	from A140 north

Staff Vehicle Movements	Assume	8%	via A148
		28%	via A47 east
		11%	from A146
		7%	from A47 west
		6%	from A1065
		16%	from A11
		13%	from A140 south
		12%	from A140 north
		12%	from A140 north

5 Light Vehicles
0 Total HGVs

PM Construction Staff Traffic Flows
Landfall

Key	
10	Light Vehicles
(10)	Heavy Goods Vehicles (HGVs)

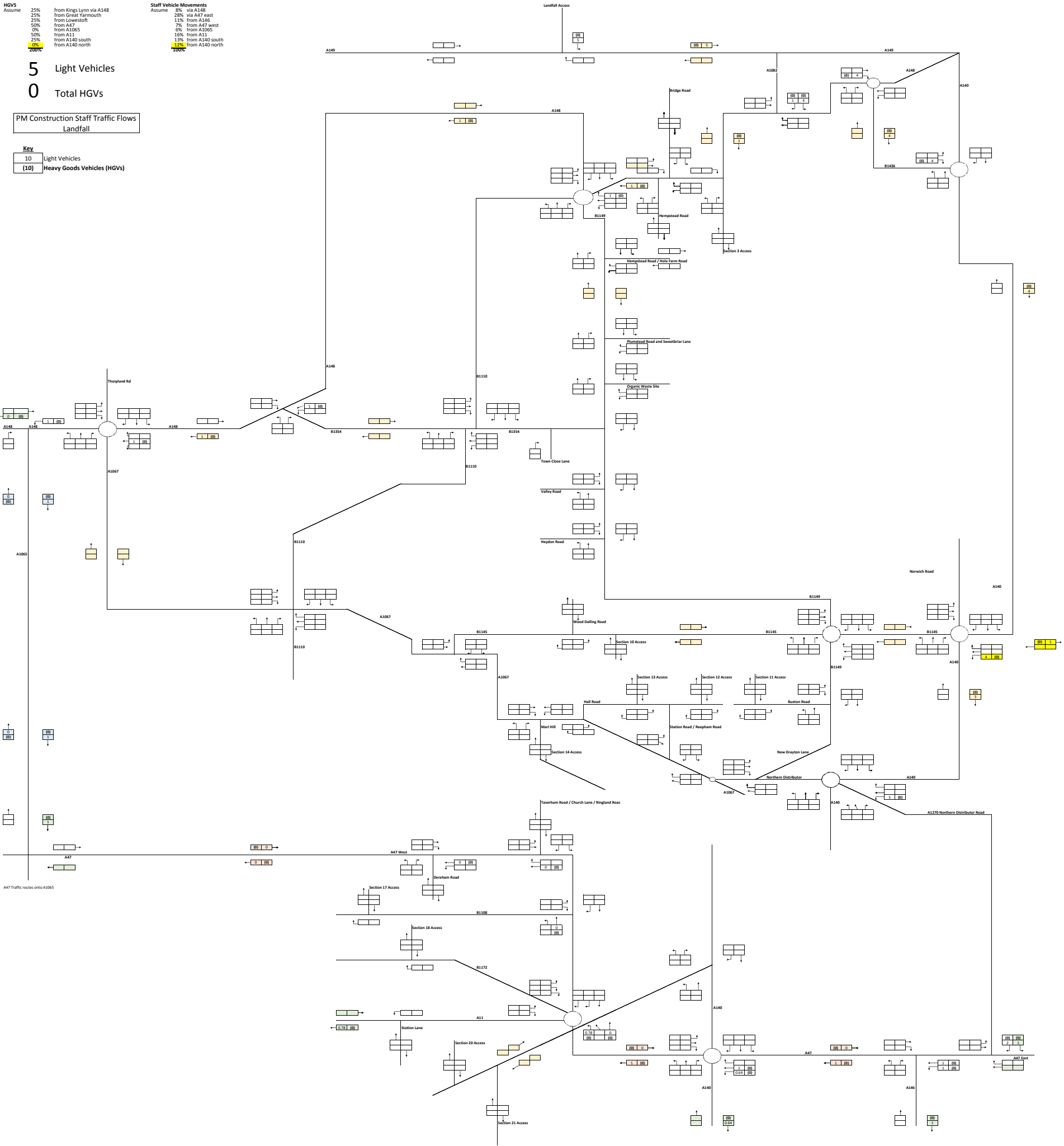

HGVs Assume	25%	from Kings Lynn via A148
	25%	from Great Yarmouth
	25%	from Lowestoft
	50%	from A47
	0%	from A1065
	50%	from A11
25%	from A140 south	
25%	from A140 north	
25%	from A140 north	
Staff Vehicle Movements Assume	8%	via A148
	28%	via A47 east
	11%	from A146
	7%	from A47 west
	6%	from A1065
	16%	from A11
13%	from A140 south	
12%	from A140 north	
12%	from A140 north	

17 Light Vehicles

0 Total HGVs

PM Construction Staff Traffic Flows
HVAC Booster Station

10	Light Vehicles
(10)	Heavy Goods Vehicles (HGVs)

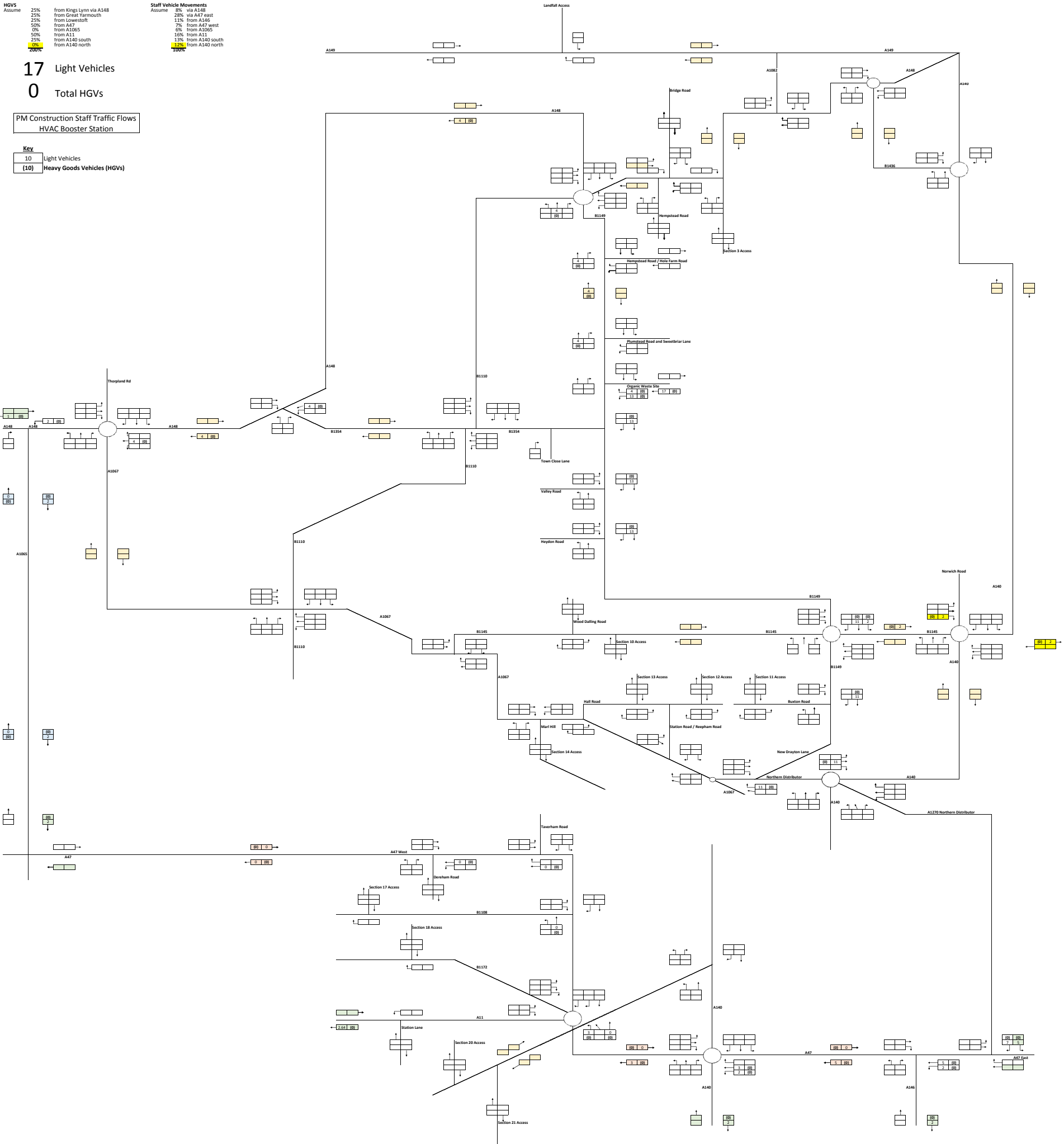

HGVS		Staff Vehicle Movements	
Assume	25%	Assume	28%
	from Kings Lynn via A47		via A148
	25%		28%
	from Great Yarmouth		via A47 east
	25%		11%
	from Lowestoft		from A146
	50%		7%
	from A47		from A47 west
	0%		6%
	from A1065 via A47		from A1065
	50%		10%
	from A11		from A11
	25%		13%
	from A140 south		from A140 south
	25%		12%
	from A140 north		from A140 north
	25%		10%

41 Light Vehicles
0 Total HGVs

PM Construction Staff Traffic Flows
HVAC Substation

Key	
10	Light Vehicles
(10)	Heavy Goods Vehicles (HGVs)

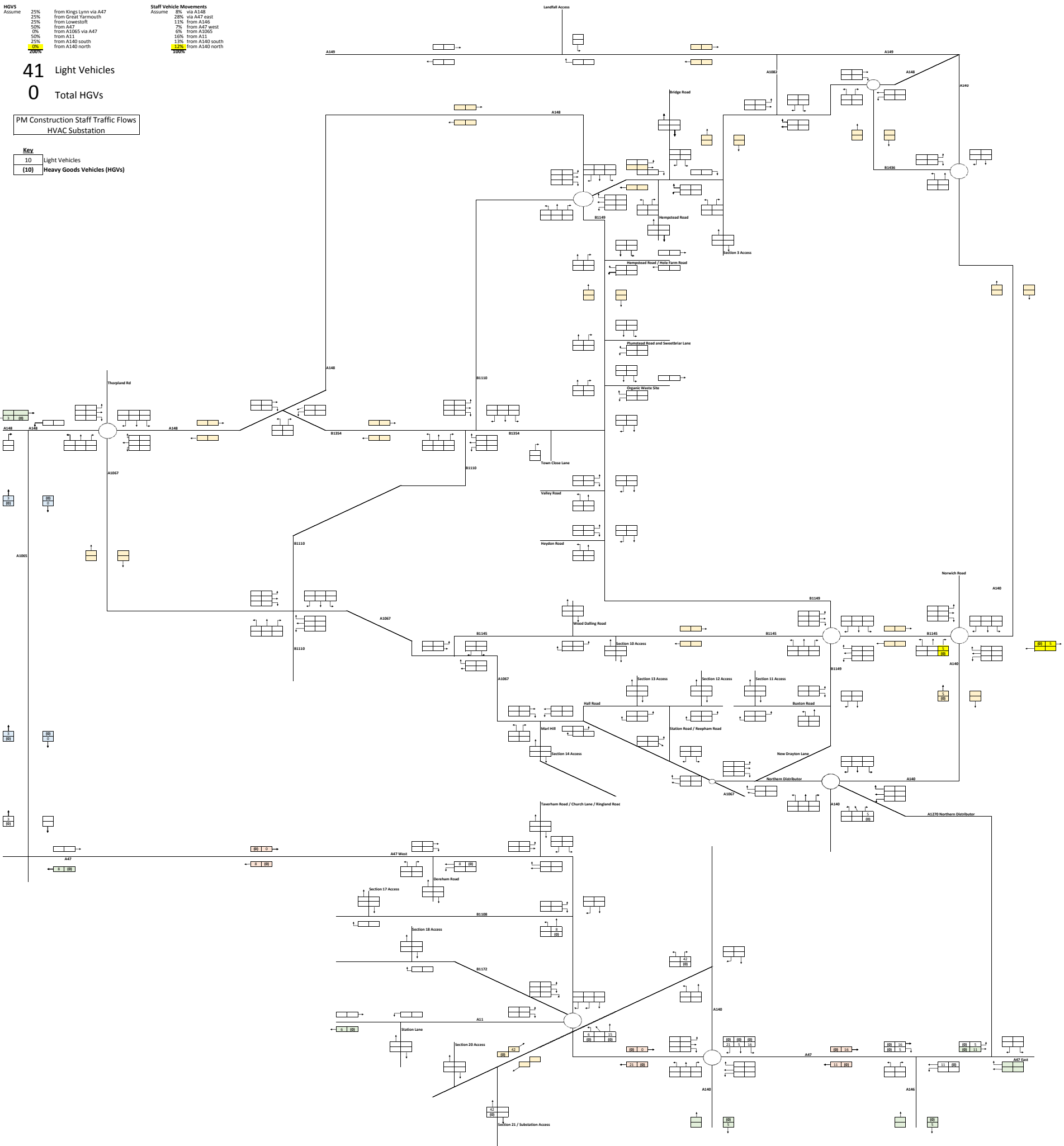

PM Construction Staff Traffic Flows
Maximum Construction Traffic

1,193 Light Vehicles

0 Total HGVs

1,193 Total Vehicles

Key	
10	Light Vehicles
(10)	Heavy Goods Vehicles (HGVs)

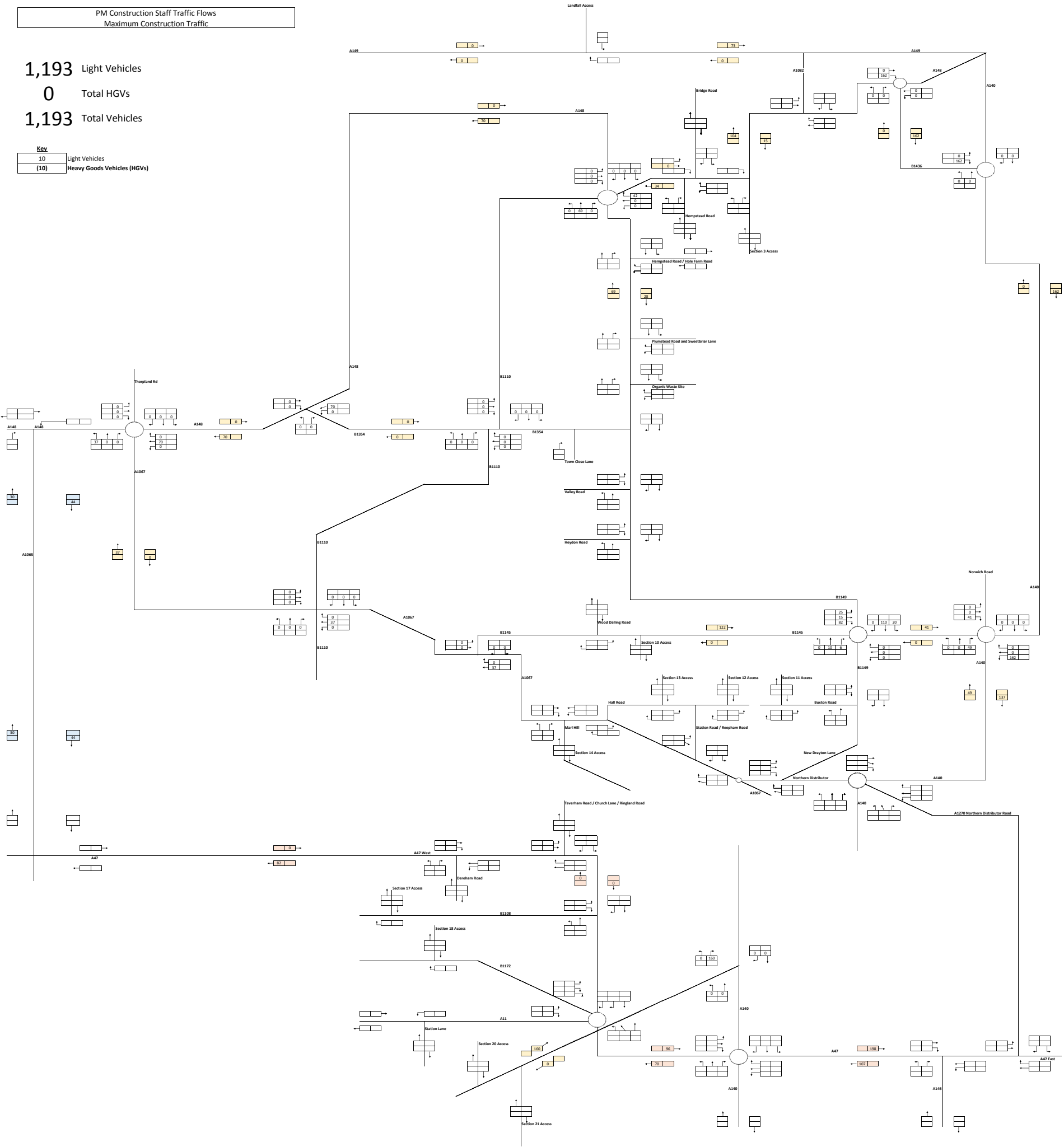

PM Construction Staff Traffic Flows
Total Construction Traffic

1,193 Light Vehicles

0 Total HGVs

1,193 Total Vehicles

Key	
10	Light Vehicles
(10)	Heavy Goods Vehicles (HGVs)

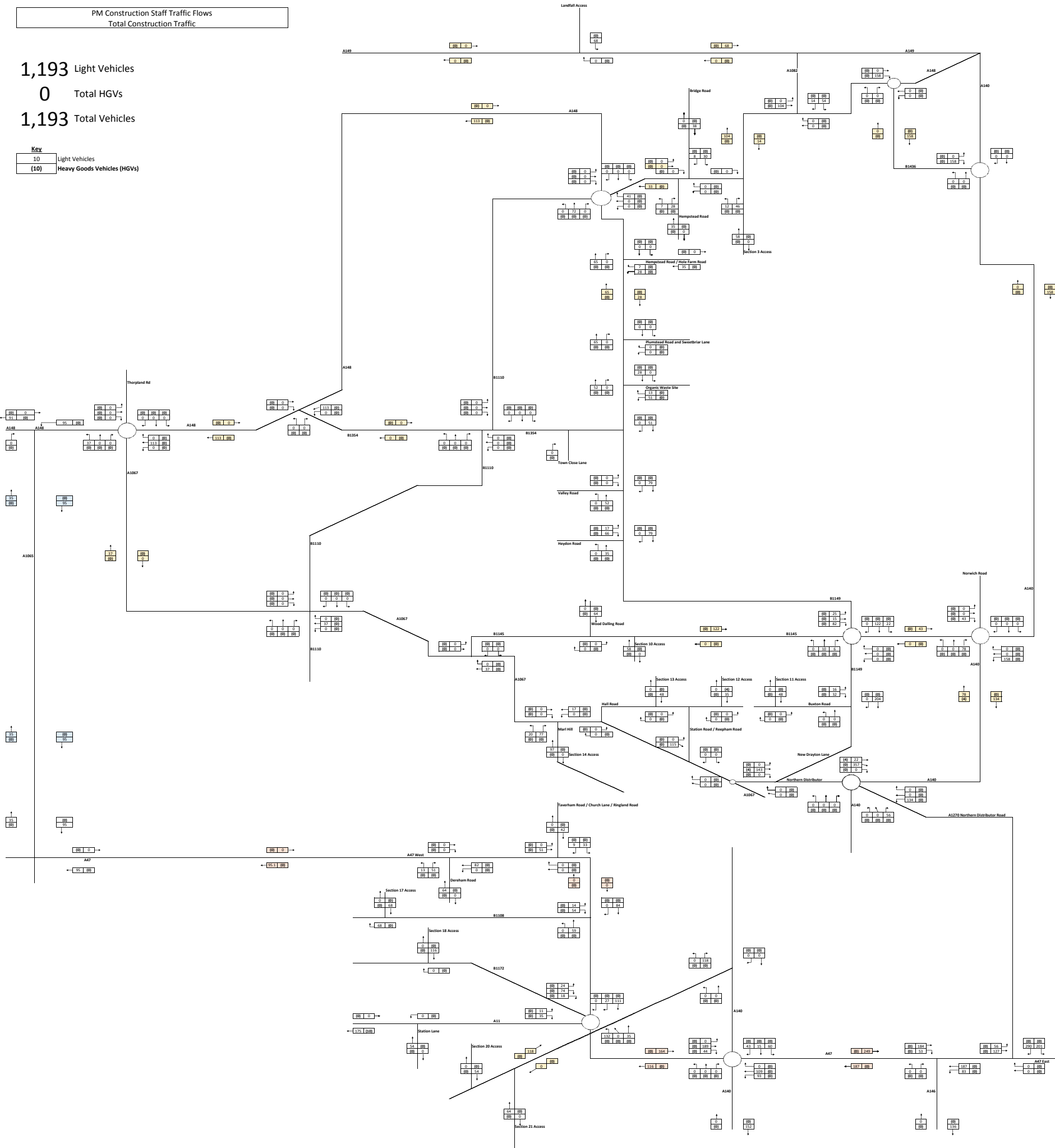

Appendix C Network Peak Calculations with Construction Flows

Traffic Flow Diagrams

Network and Construction Peak
Comparisons

Network Peak Calcs

All turning movements across all Manual Counts

	CAR	LGV	OGV1	OGV2	PSV	MBIKE	CYC	TOT HVs	VEH TOT
0700-0800	8319	2439	390	271	79	87	21	740	11585
0715-0815	9706	2413	438	289	86	89	21	813	13021
0730-0830	10646	2347	468	319	98	92	17	885	13970
0745-0845	11194	2182	482	317	106	102	21	905	14383
0800-0900	11159	2013	482	326	115	97	19	923	14192
0815-0915	10706	1901	488	318	114	82	18	920	13609
0830-0930	10244	1835	484	294	103	73	24	881	13033
0845-0945	9664	1746	461	297	96	58	20	854	12322
0900-1000	9376	1661	458	289	91	53	20	838	11928
0915-1015	9213	1611	445	290	98	54	23	833	11711
0930-1030	9201	1479	425	292	92	56	26	809	11545
0945-1045	9313	1477	436	288	89	56	33	813	11659
1000-1100	9293	1470	440	275	81	67	32	796	11626
1015-1115	9366	1450	433	275	73	80	33	781	11677
1030-1130	9258	1466	413	267	77	82	27	757	11563
1045-1145	9053	1469	396	248	69	92	27	713	11327
1100-1200	9024	1468	376	233	70	82	29	679	11253
1115-1215	8999	1467	355	222	66	79	23	643	11188
1130-1230	9023	1506	354	216	60	79	23	630	11238
1145-1245	9001	1479	339	227	59	67	17	625	11172
1200-1300	8963	1482	335	232	59	69	20	626	11140
1215-1315	8835	1486	345	226	61	75	24	632	11028
1230-1330	8693	1420	348	223	67	79	20	638	10830
1245-1345	8776	1423	345	215	76	89	27	636	10924
1300-1400	8626	1392	359	217	79	98	23	655	10771
1315-1415	8755	1384	374	221	81	97	22	676	10912
1330-1430	8907	1394	386	221	89	99	24	696	11096
1345-1445	9104	1403	386	219	91	91	16	696	11294
1400-1500	9398	1471	364	224	98	87	14	686	11642
1415-1515	9558	1519	334	222	103	99	14	659	11835
1430-1530	9960	1585	313	216	93	102	17	622	12269
1445-1545	10250	1670	315	207	90	107	19	612	12639
1500-1600	10628	1780	333	197	91	121	24	621	13150
1515-1615	11084	1972	340	174	94	119	23	608	13783
1530-1630	11314	2182	357	165	111	127	20	633	14256
1545-1645	11552	2403	351	161	109	153	23	621	14729
1600-1700	11937	2454	302	149	97	155	28	548	15094
1615-1715	12447	2415	274	159	88	180	29	521	15563
1630-1730	13007	2310	218	150	76	212	44	444	15973
1645-1745	13051	2020	170	131	71	205	45	372	15648
1700-1800	12583	1722	152	102	78	227	41	332	14864
1715-1815	11744	1428	122	78	79	213	45	279	13664
1730-1830	10501	1146	106	53	69	196	43	228	12071
1745-1845	9345	910	86	38	69	192	62	193	10640
1800-1900	8390	807	71	36	57	179	78	164	9540

2017 Network Peak
 AM (07:45-08:45)

Key
 10 Total Vehicles
 (10) Heavy Goods Vehicles (HGVs)

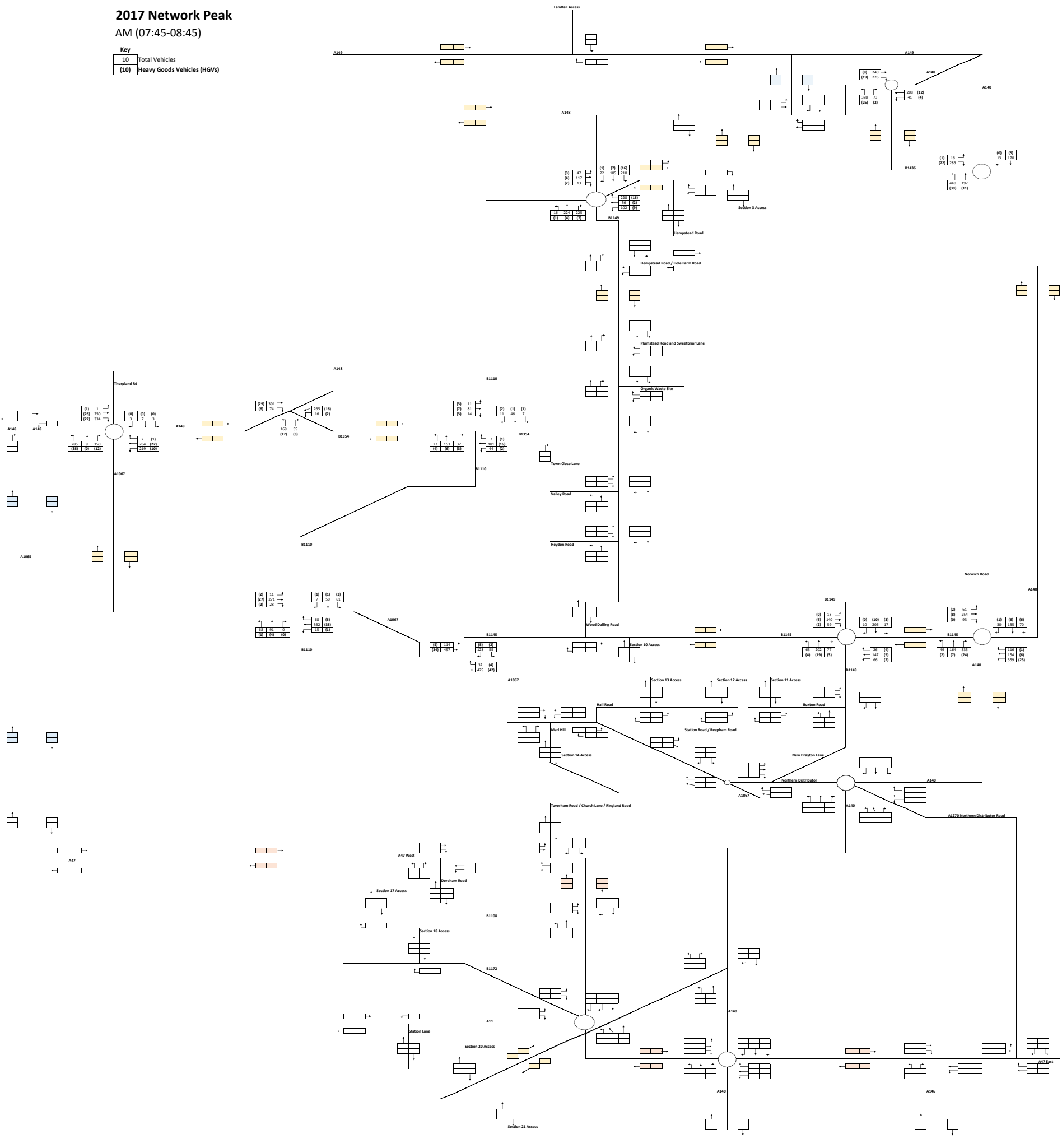

TEMPO
Average Weekday

Thick	1.30	growth 2017-2022
Principal	1.00	growth 2017-2022
Minor	1.00	growth 2017-2022

2022 Network Peak AM (07:45-08:45)

Key

10	Total Vehicles
(10)	Heavy Goods Vehicles (HGVs)

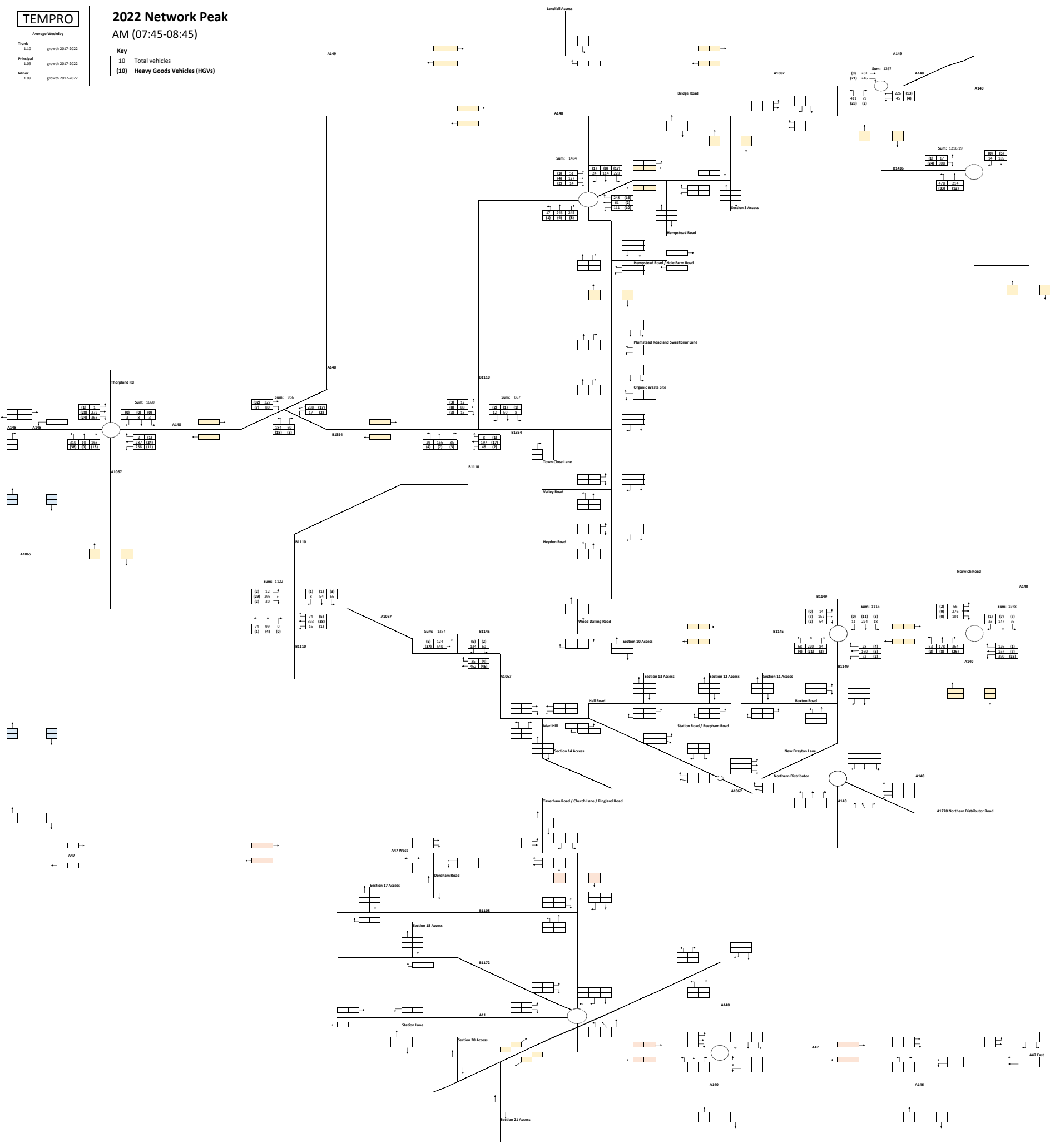

Base + Max Construction - Network Peak
AM

Key

10	Total vehicles
10	Heavy Goods Vehicles (HGVs)

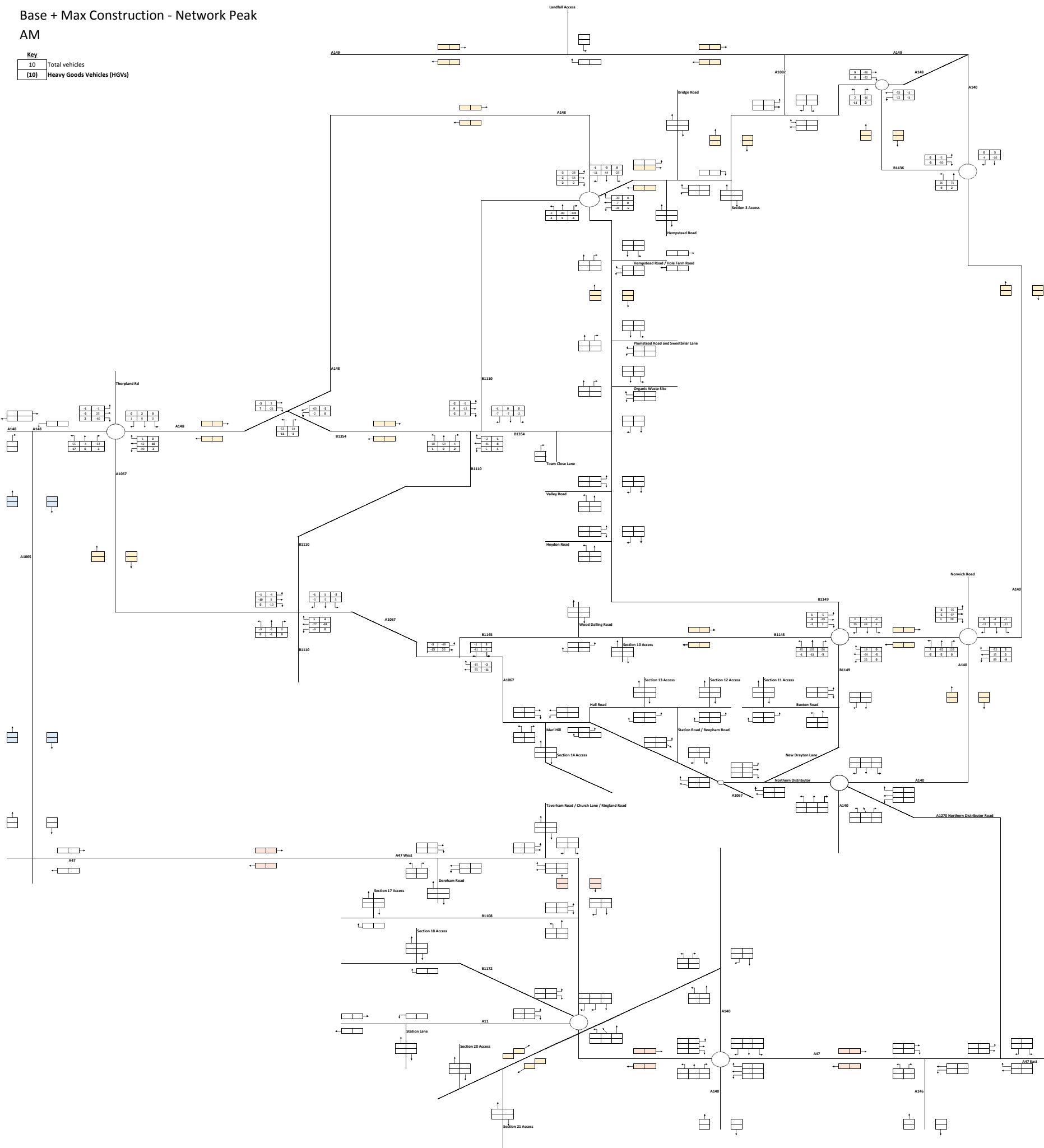

TEMPO

Average Weekday

Thick	1.50	growth 2017-2022
Principal	1.00	growth 2017-2022
Minor	1.00	growth 2017-2022

2022 Network Peak + HGVs
AM (07:45-08:45)

Key

10 Total Vehicles

(10) Heavy Goods Vehicles (HGVs)

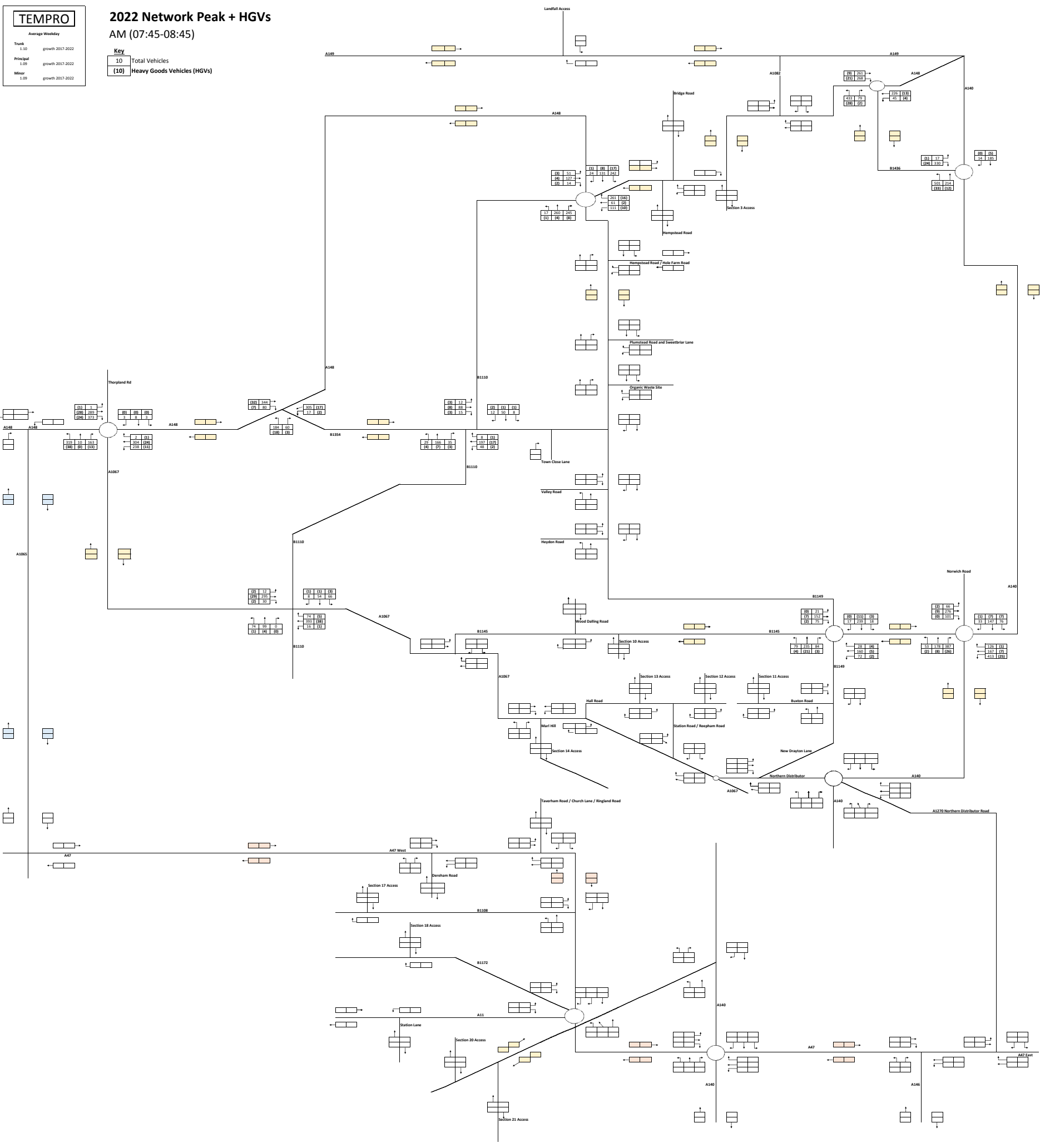

2017 Network Peak
PM (16:30-17:30)

Key
10 Total Vehicles
10 Heavy Goods Vehicles (HGVs)

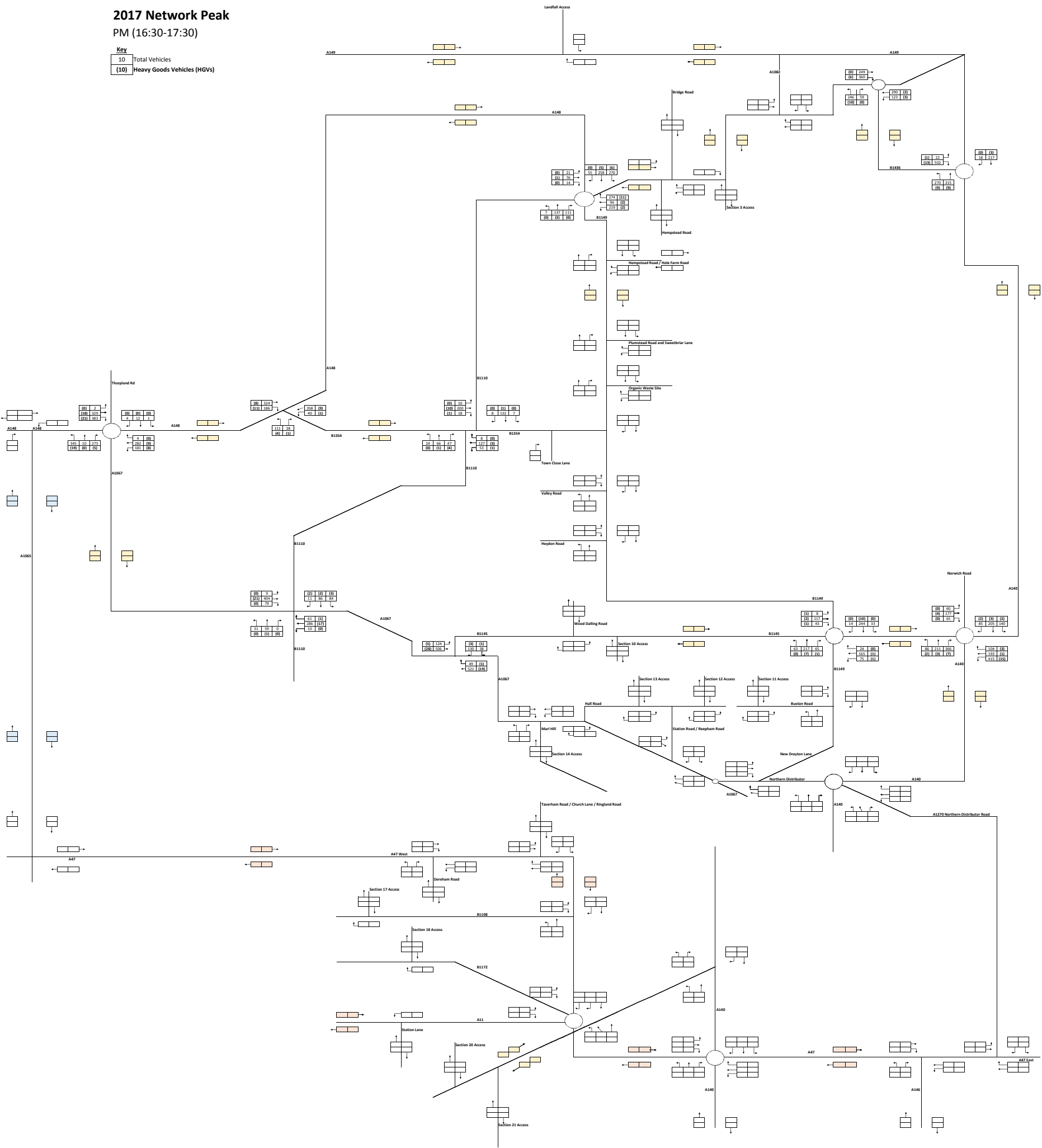

TEMPRO

Average Weekday

Trunk	1.30	growth 2017-2022
Principal	1.00	growth 2017-2022
Minor	1.00	growth 2017-2022

2022 Network Peak PM (16:30-17:30)

Key

10	Total Vehicles
(10)	Heavy Goods Vehicles (HGVs)

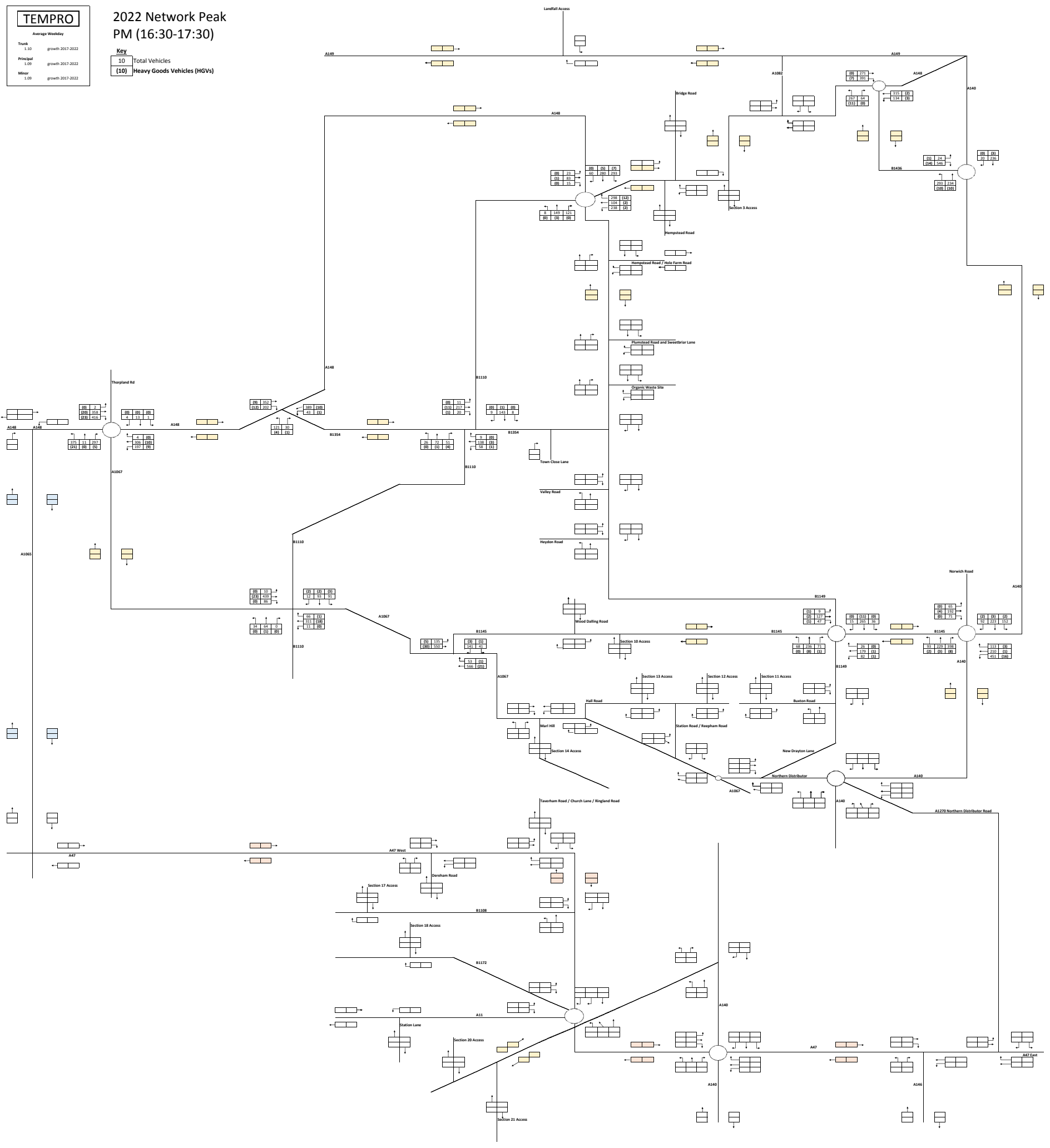

Base + Max Construction - Network Peak
PM

Key

10	Total vehicles
10	Heavy Goods Vehicles (HGVs)

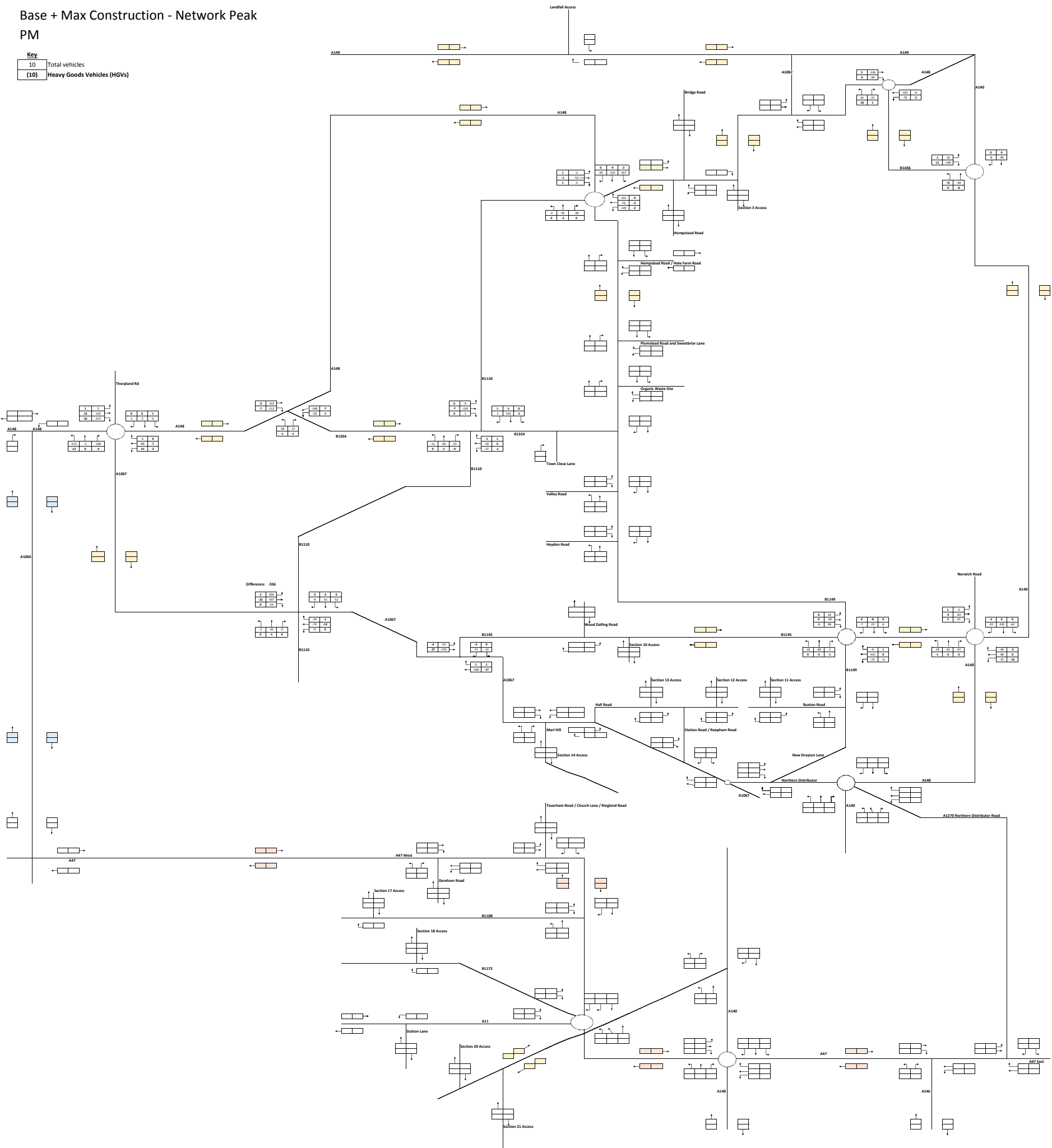

TEMPRO

Average Weekday

Thick	1.50	growth 2017-2022
Principal	1.00	growth 2017-2022
Minor	1.00	growth 2017-2022

2022 Network Peak + HGVs PM (16:30-17:30)

Key	
10	Total Vehicles
(10)	Heavy Goods Vehicles (HGVs)

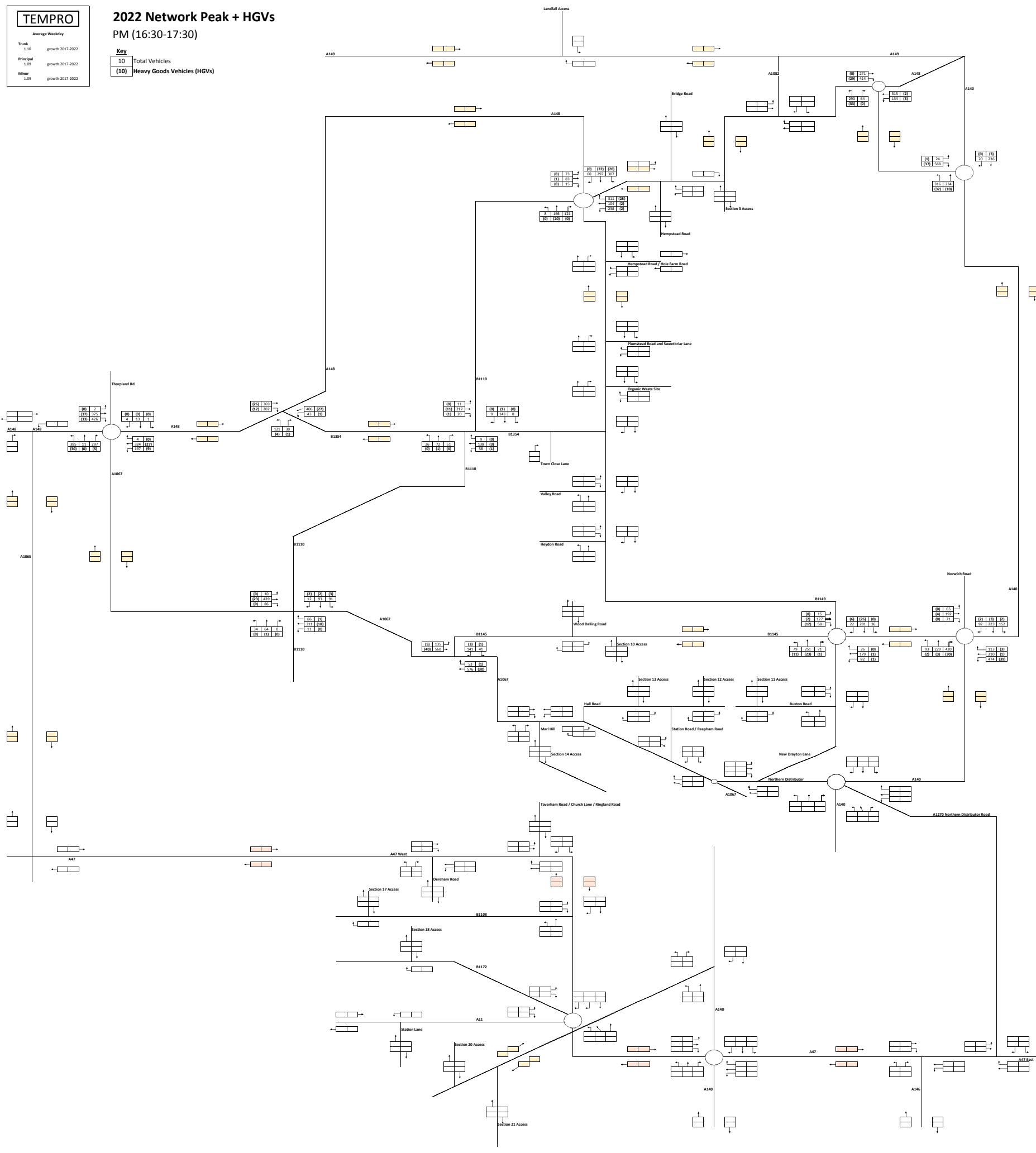

KEY

10	Lights
11	HGVs

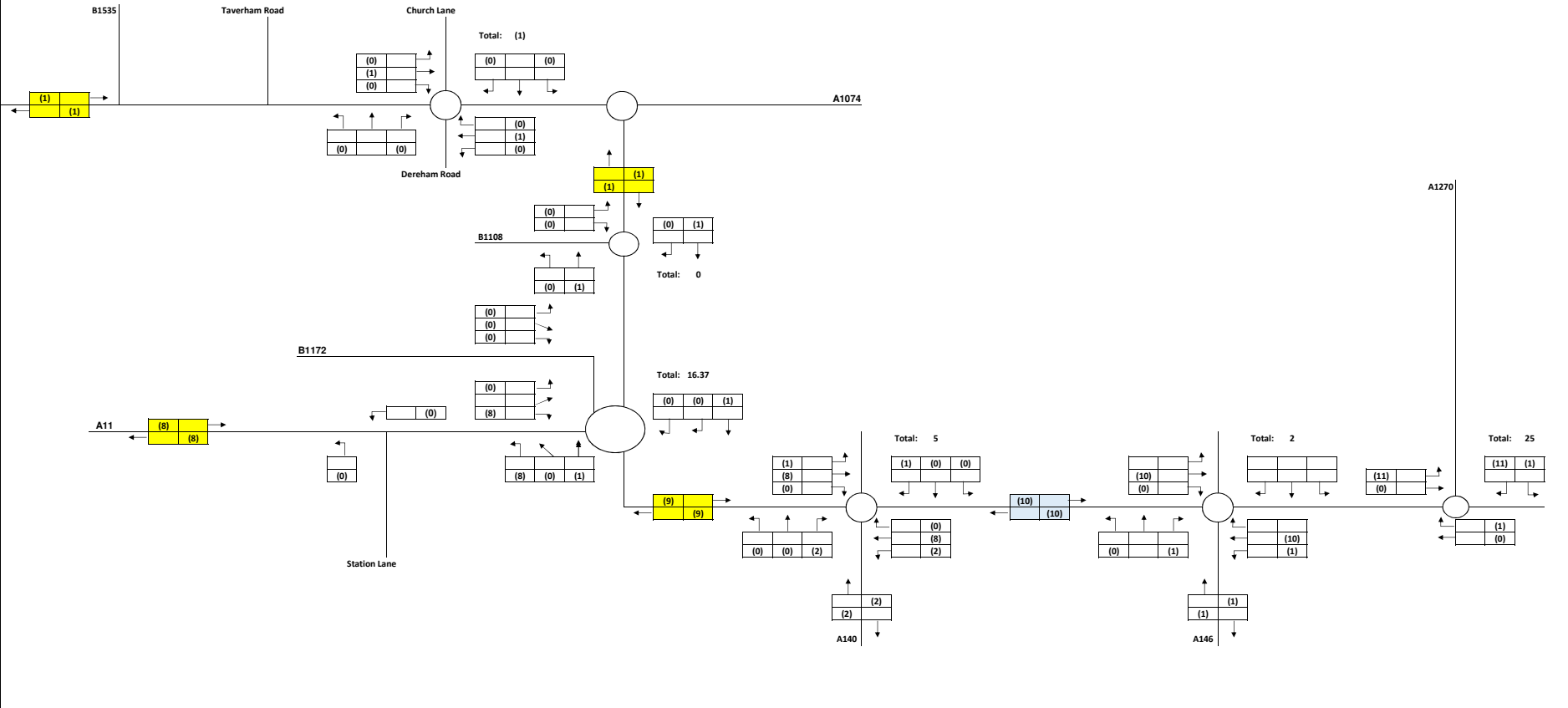

Project	JNY8772 Hornsea Project Three
Figure	
Title	Northern Group + Landfall + Booster Station + Substation Hourly HGV Flows

KEY

10	Lights
11	HGVs

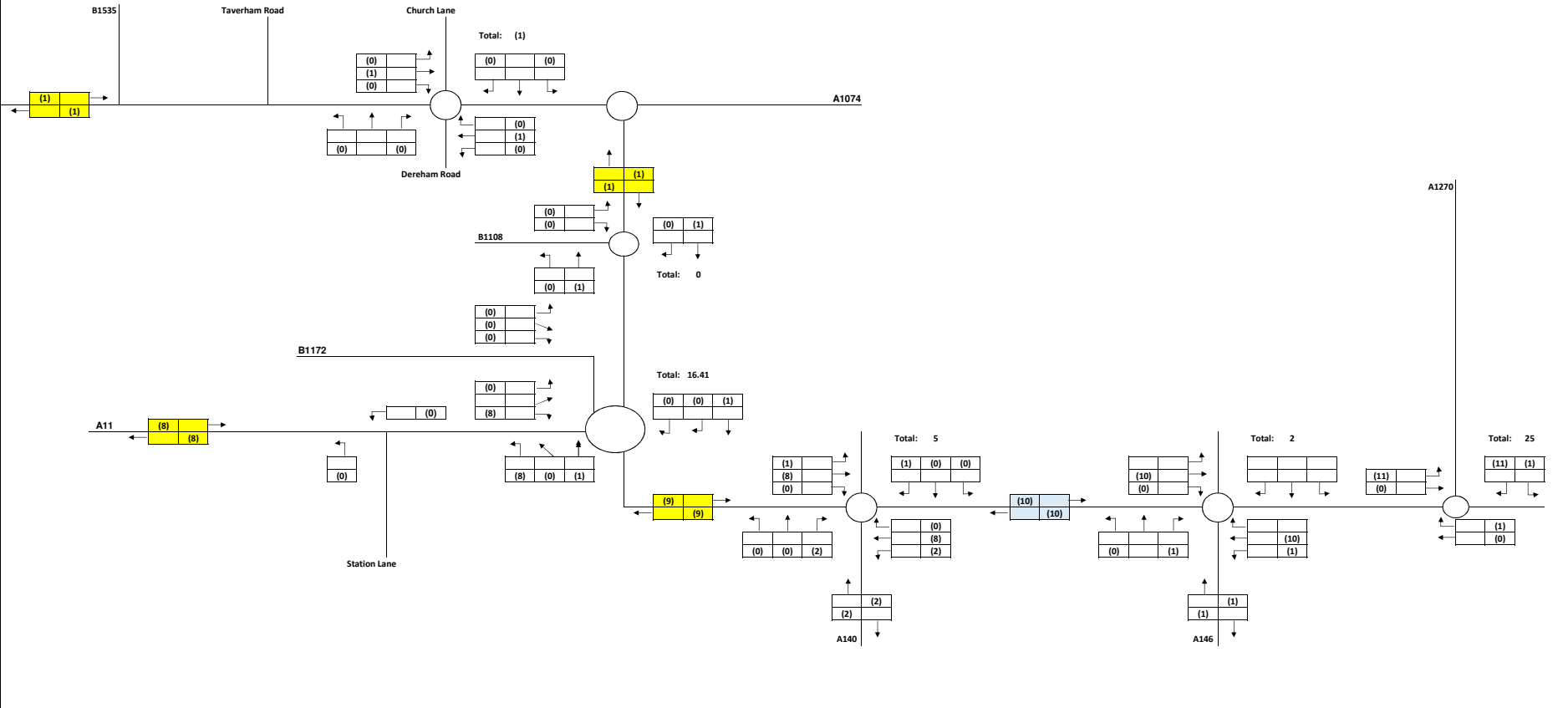

Project	JNY8772 Hornsea Project Three
Figure	
Title	Middle (northern) Group + Landfall + Booster Station + Substation Hourly HGV Flows

KEY

10	Lights
(1)	HGVs

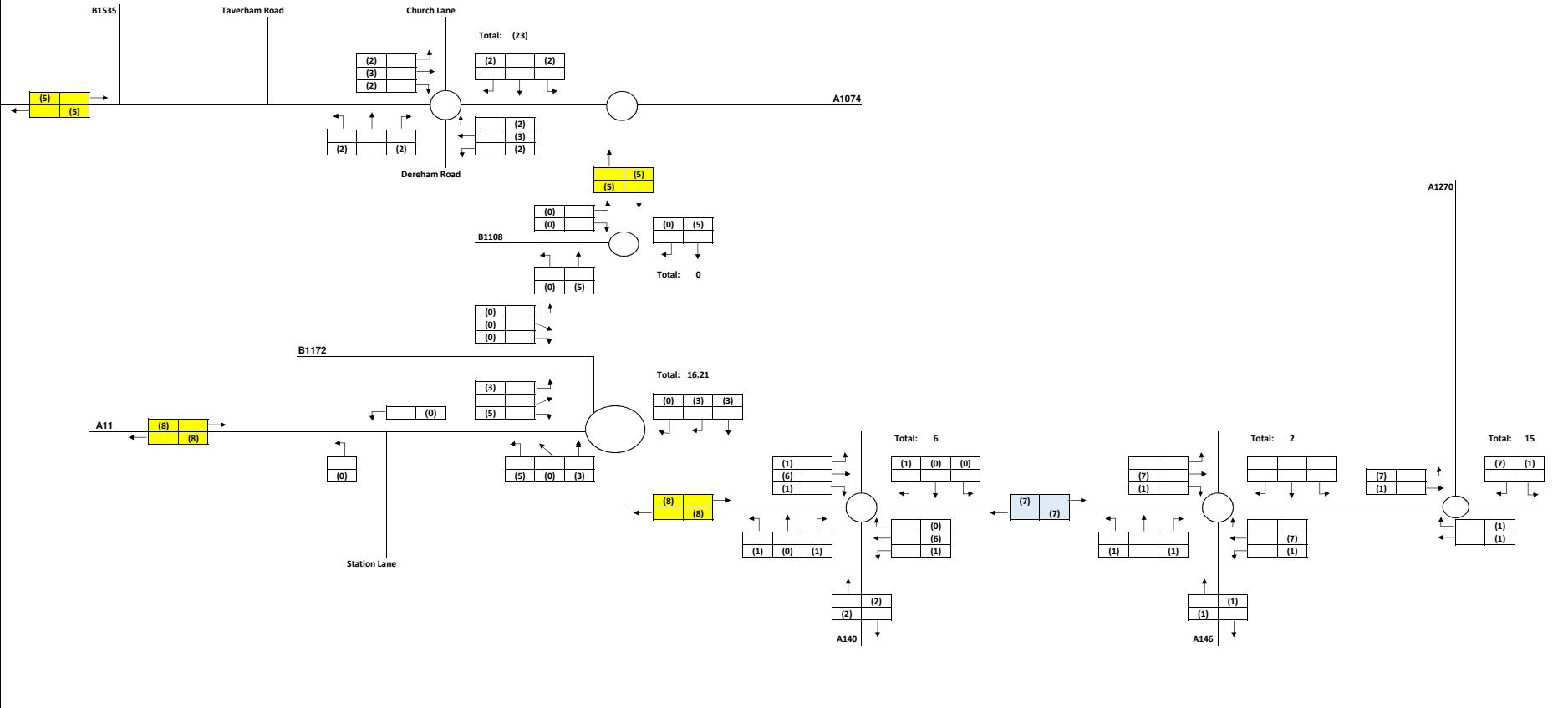

Project	JNY8772 Hornsea Project Three
Figure	
Title	Middle (southern) Group + Landfall + Booster Station + Substation Hourly HGV Flows

KEY

10	Lights
(1)	HGVs

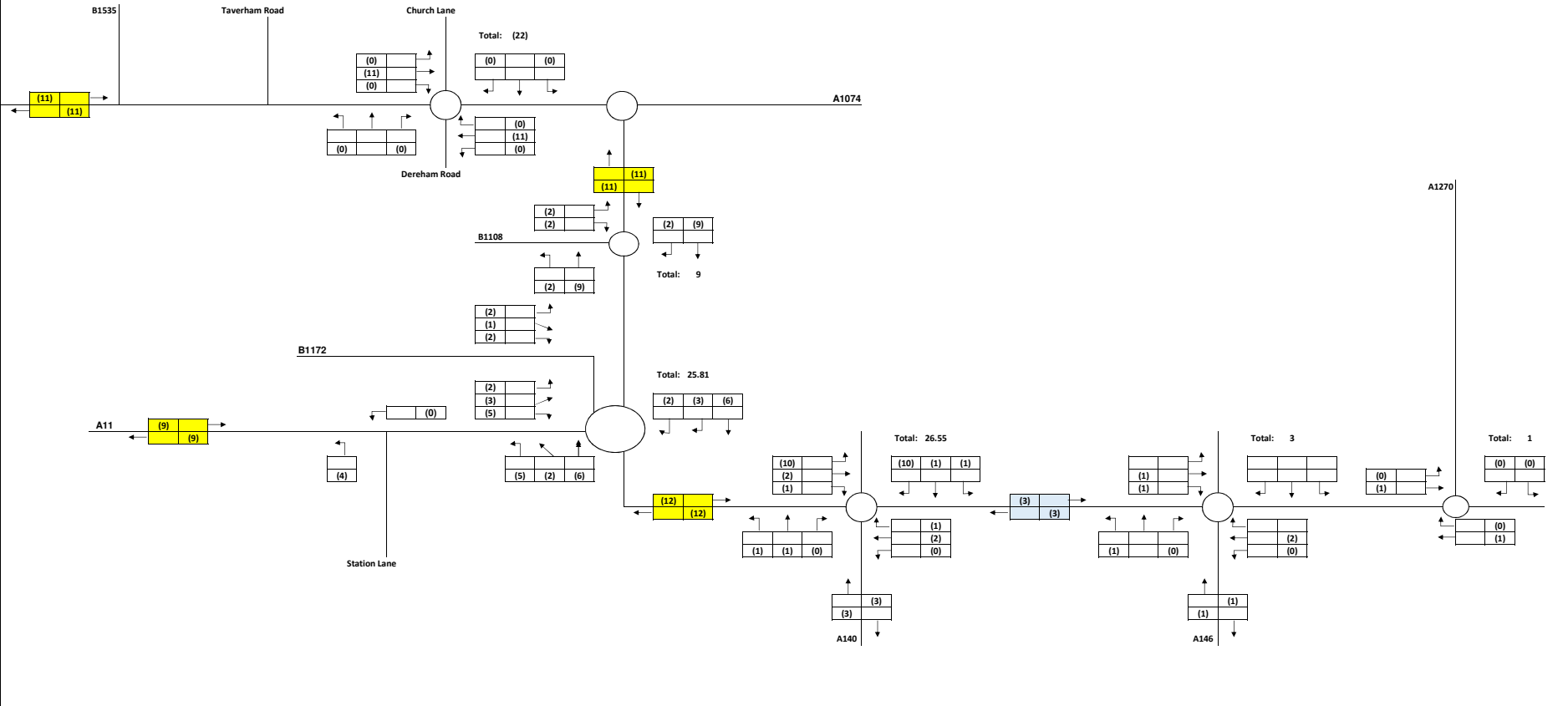

Project	JNY8772 Hornsea Project Three
Figure	
Title	Southern Group + Landfall + Booster Station + Substation Hourly HGV Flows

KEY

10	Lights
(1)	HGVs

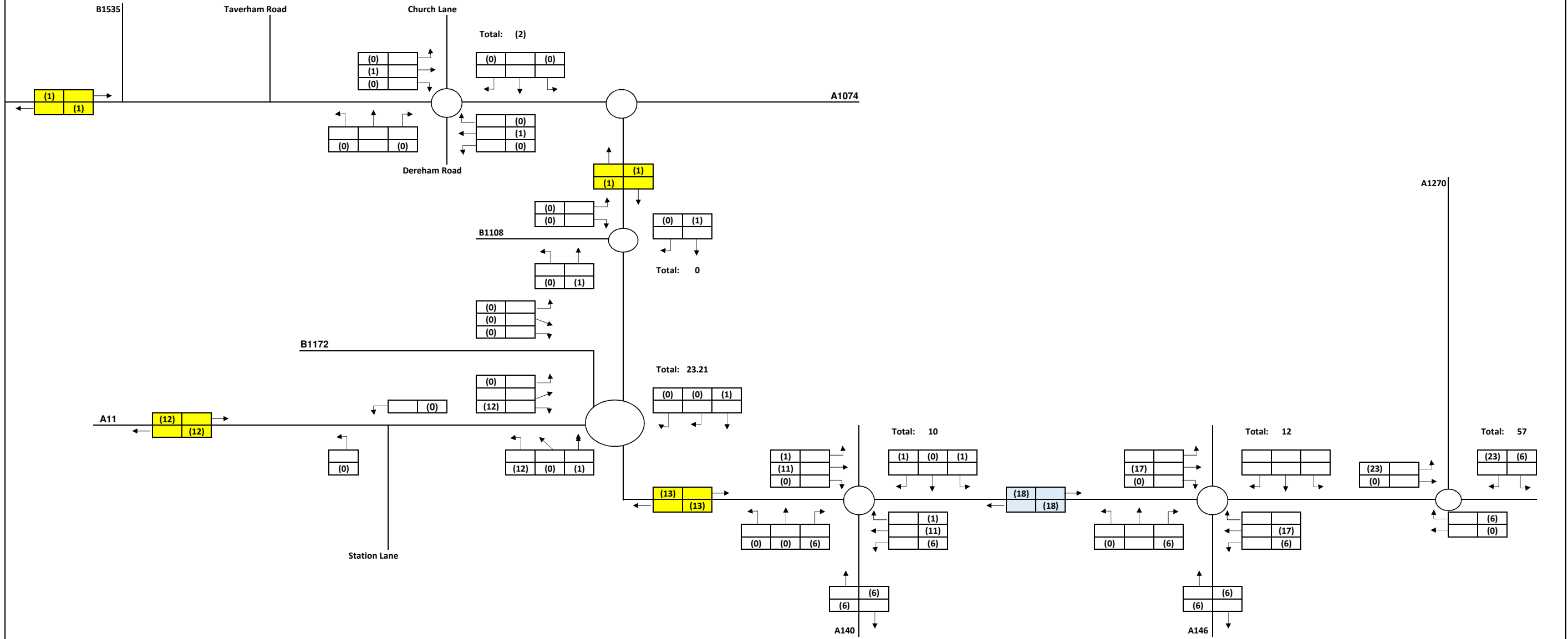

Project	JNY8772 Hornsea Project Three
Figure	
Title	Northern Group + Landfall + Booster Station + Substation Hourly HGV Flows (Sensitivity Scenario)

KEY

10	Lights
11	HGVs

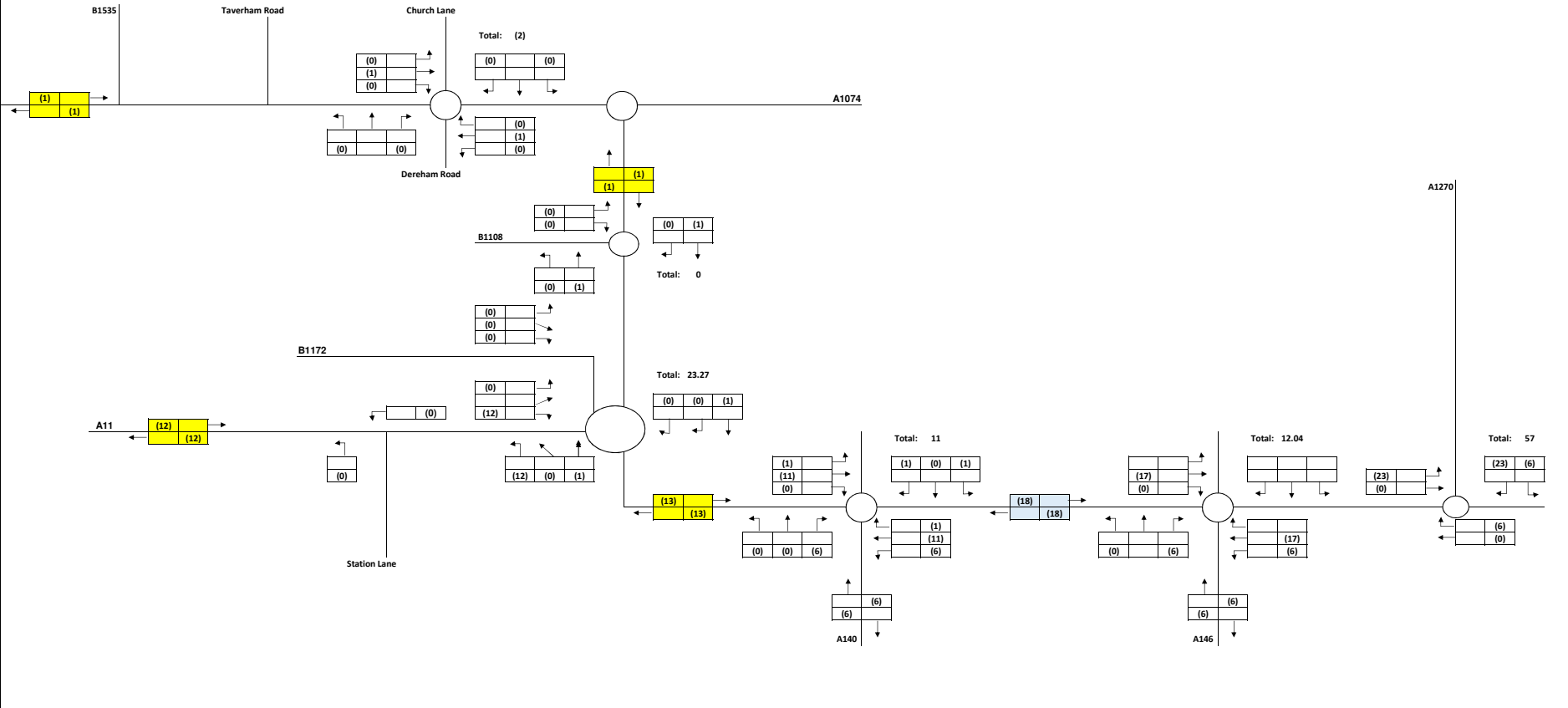

Project	JNY8772 Hornsea Project Three
Figure	
Title	Middle (northern) Group + Landfall + Booster Station + Substation Hourly HGV Flows (Sensitivity Scenario)

KEY

10 Lights
 (1) HGVs

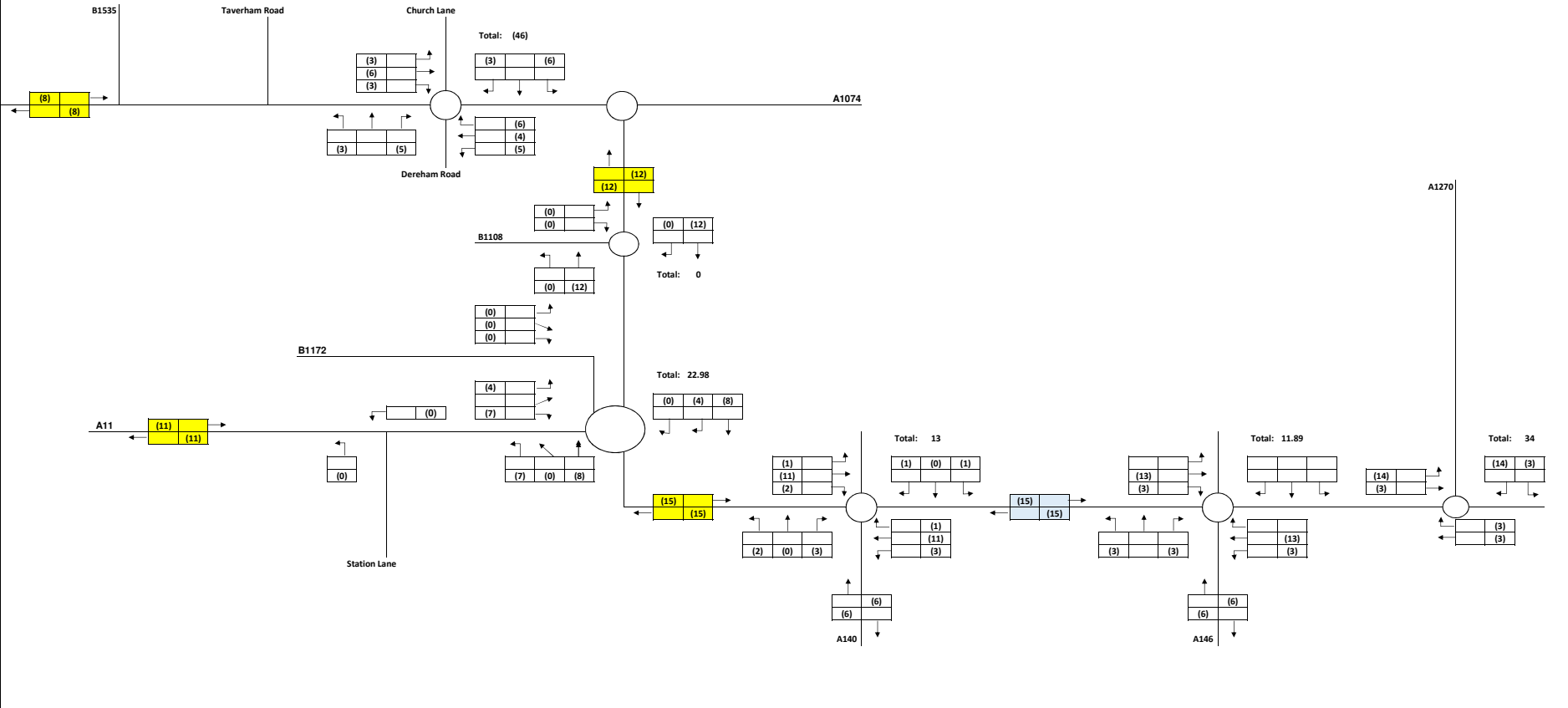

Project	JNY8772 Hornsea Project Three
Figure	
Title	Middle (southern) Group + Landfall + Booster Station + Substation Hourly HGV Flows (Sensitivity Scenario)

KEY

10	Lights
(1)	HGVs

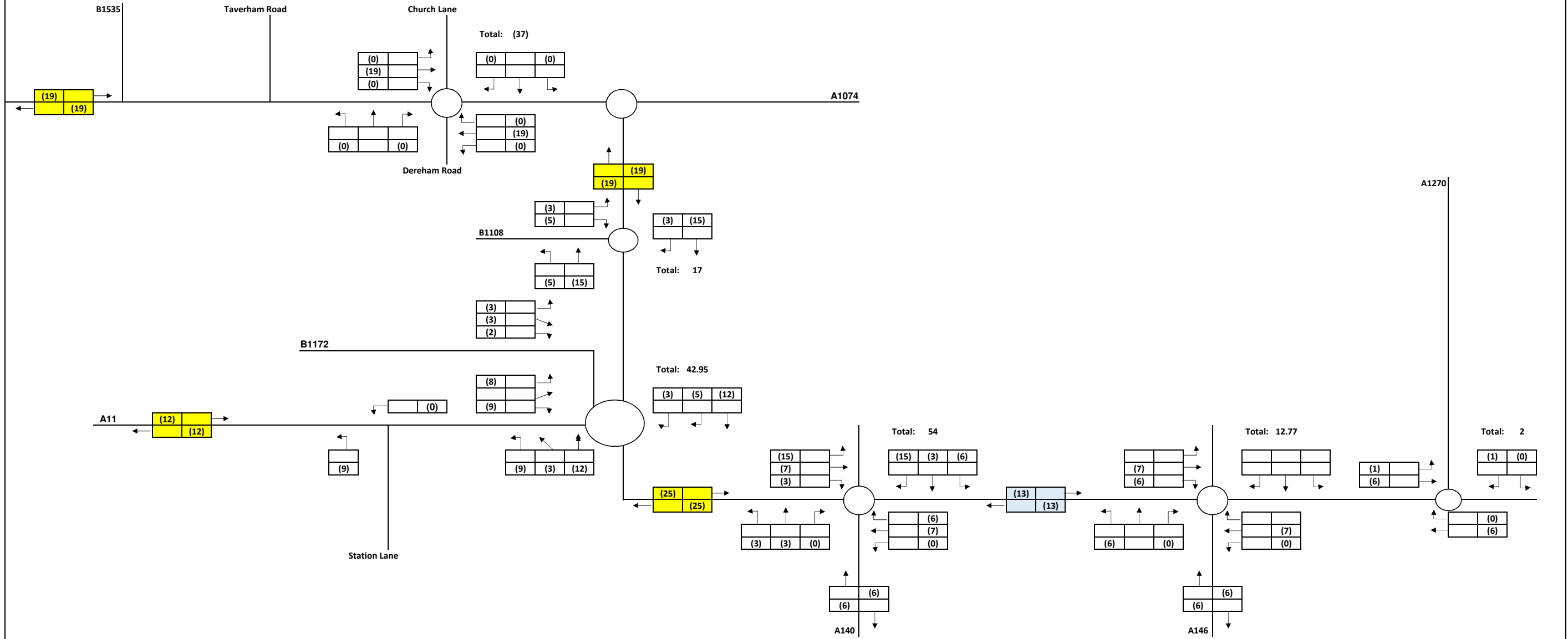

Project	JNY8772 Hornsea Project Three
Figure	
Title	Southern Group + Landfall + Booster Station + Substation Hourly HGV Flows (Sensitivity Scenario)

KEY
 AM Network Peak Hour: 07:00-08:00

10	Totals
(t)	HGVs

Source
 Highways England
 Department for Transport

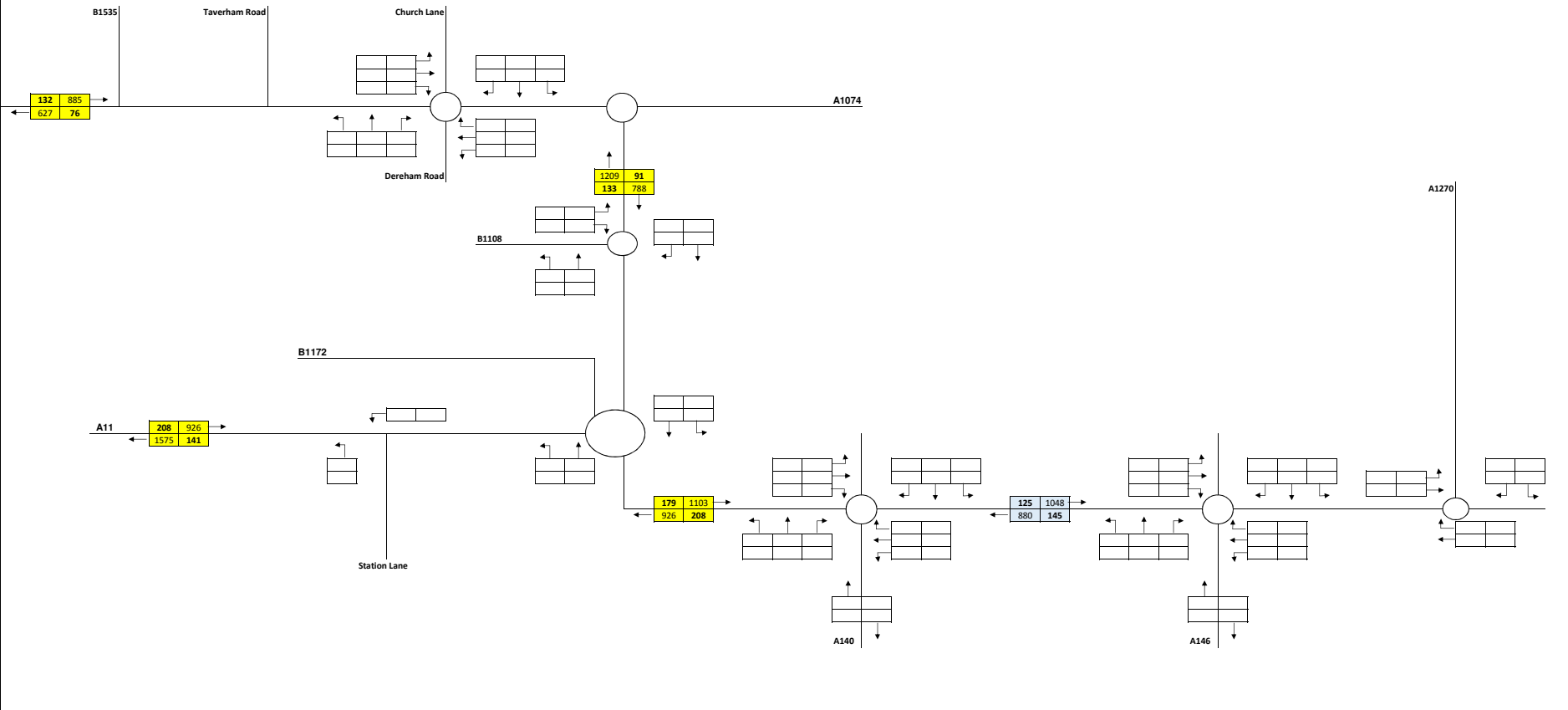

Project	JNY8772 Hornsea Project Three
Title	2022 06:00-07:00 Weekday Traffic Flows

KEY
AM Network Peak Hour: 07:00-08:00

10	Totals
(t)	HGVs

Source
 Highways England
 Department for Transport

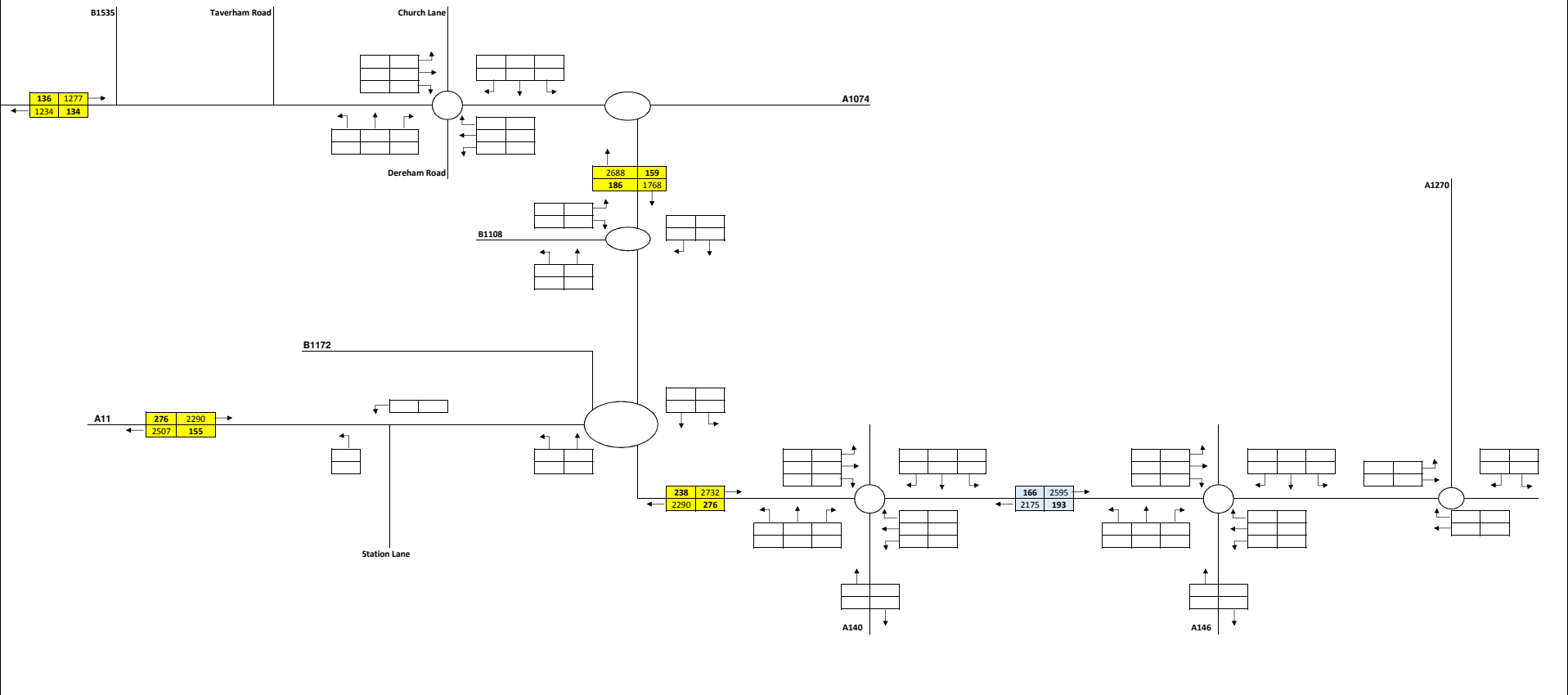

Project

JN8772 Hornsea Project Three

Title

2022 07:00-08:00 Weekday Traffic Flows

KEY
AM Network Peak Hour: 07:00-08:00

10 Totals
(t) HGVs

Source
Highways England
Department for Transport

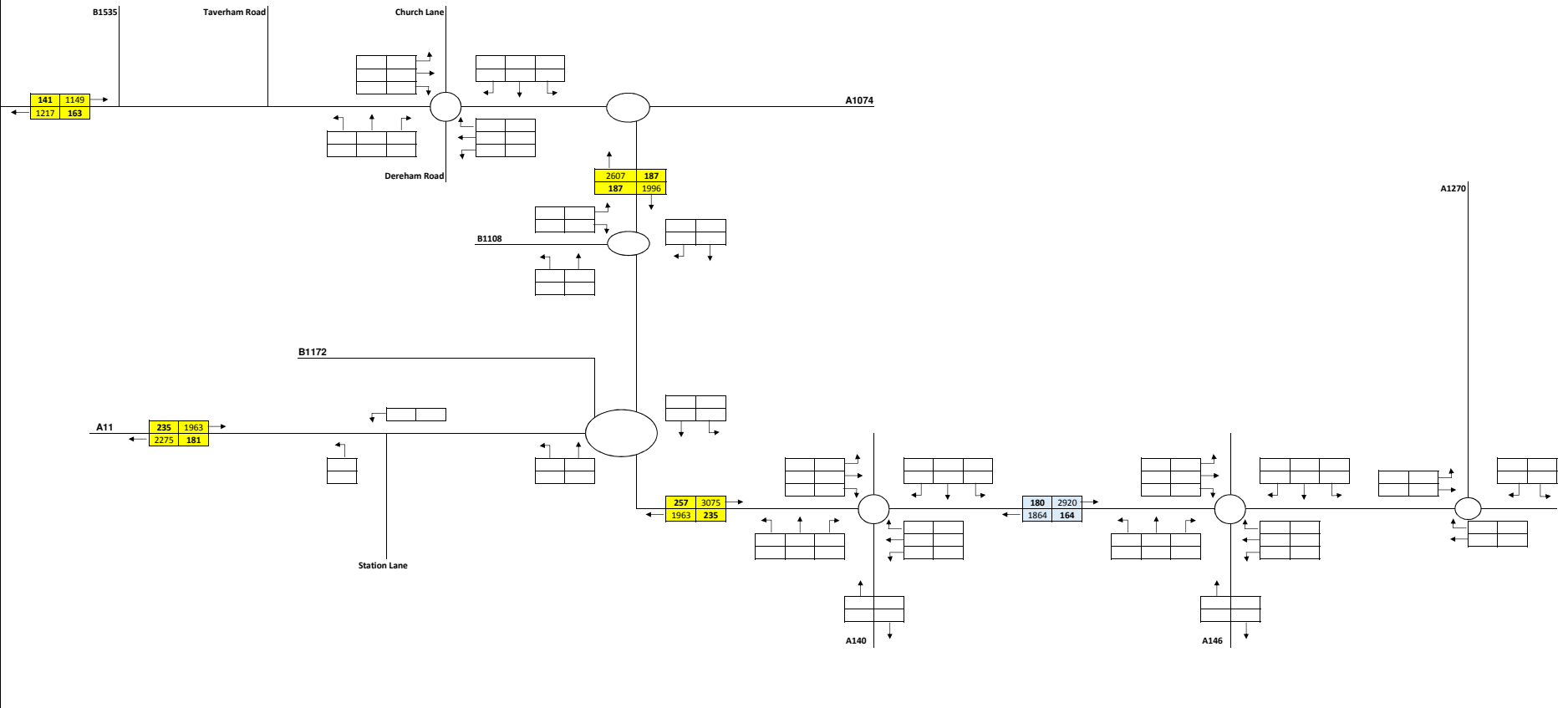

Project	JNY8772 Hornsea Project Three
Title	2022 08:00-09:00 Weekday Traffic Flows

KEY
AM Network Peak Hour: 17:00-18:00

10	Totals
(t)	HGVs

Source
 Highways England
 Department for Transport

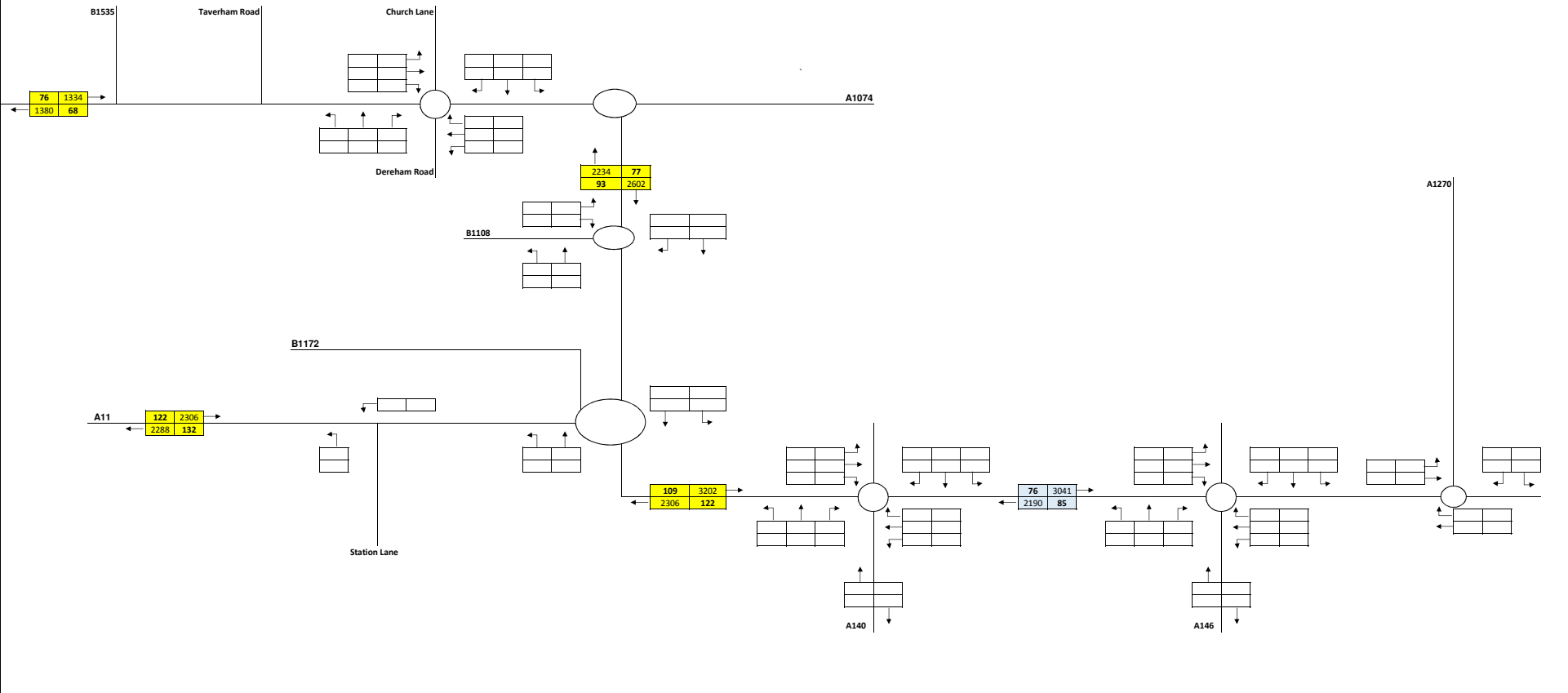

Project	JNY8772 Hornsea Project Three
Title	2022 1700-1800 Weekday Traffic Flows

KEY
AM Network Peak Hour: 17:00-18:00

10	Totals
(t)	HGVs

Source
 Highways England
 Department for Transport

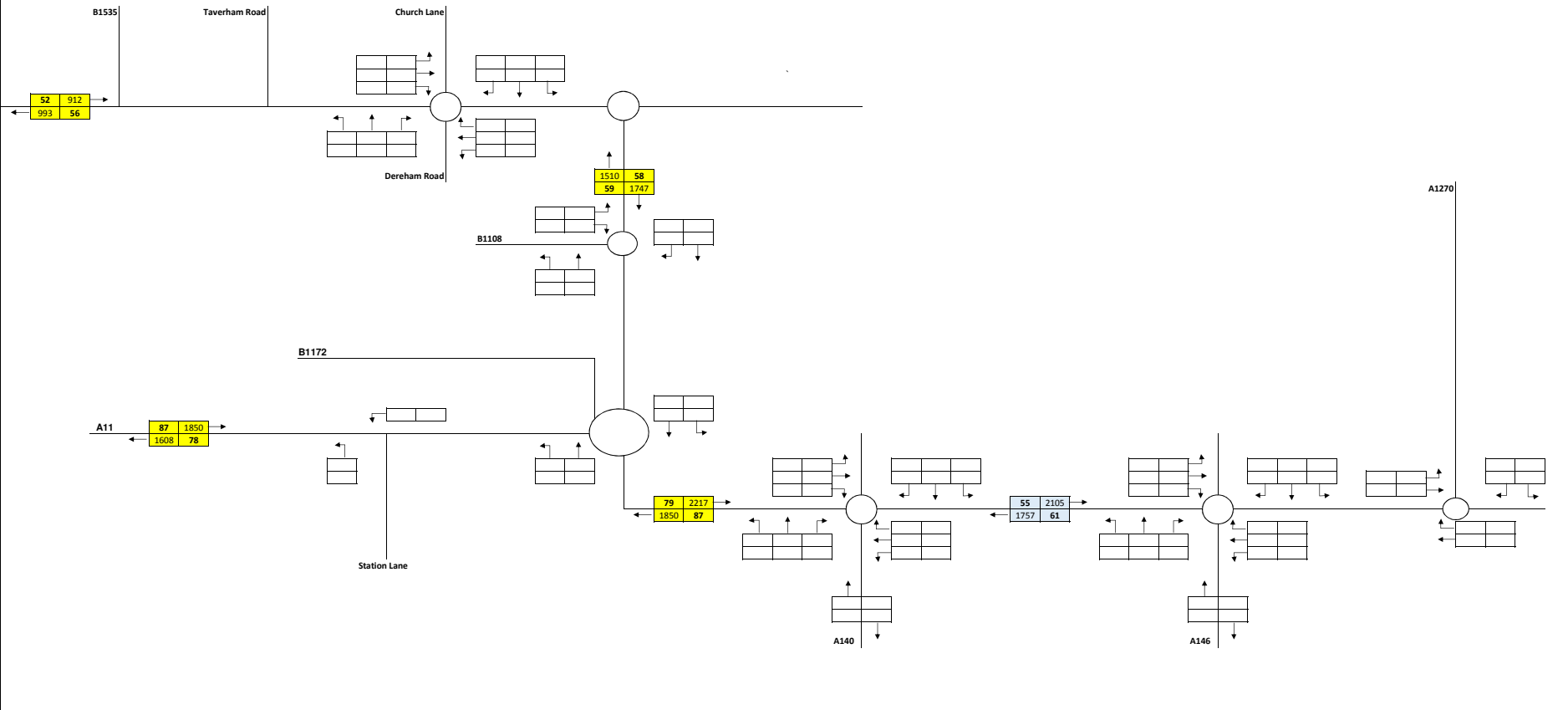

Project	JNY8772 Hornsea Project Three
Title	2022 1800-1900 Weekday Traffic Flows

Appendix D Signalised Junction

CONTROLLER.....ST400
 MONITOR.....OTU
 BT LINE NUMBER..REPLIES VIA LINK TO INST 63, LINE NO ANUK 511737

I	TO PHASE															
	a	b	c	d	e	f	g	h	i	j	k	l	m	n	o	p
a	X		5	7	6											
b		X			5											
c	6		X		6											
d	5			X												
e	5	6	6		X											
f						X										
g							X									
h								X								
i									X							
j										X						
k											X					
l												X				
m													X			
n														X		
o															X	
p																X

PHASE	PEDESTRIAN BLACK-OUT	MINIMUM GREEN	EXTENSIONS	MAXIMUM SET A	MAXIMUM SET B	DELAY PHASE UPON CHANGE FROM STAGE	TO STAGE	BY...SECONDS
a	7	1.6	30	36	b	1	3	1
b	7	1.6	32	36	d	2	1	2
c	7	1.6	12	8	a	0	0	0
d	7	1.6	15	28				
e	7	1.6	8	8				
f								
g								
h								
i								
j								
k								
l								
m								
n								
o								
p								

ROUTINE MAINTENANCE INSPECTION SHEET

Remedial action taken or required:

Inspector:

Date:

Time:

CHECK LIST	✓/✗
CONTROLLER CASE	
Doors, flap etc.	
TIMINGS	
HEADS	
Bodies	
Lamps	
Lenses	
Transformers	
Alignment	
Backing boards	
Box signs	
POLES	
Pole caps	
Brackets	
DETECTION	
Loops V.A.	
Loops SCOOT	
SA	
Chambers	
PUSH BUTTONS	
MARKINGS/STUDS	
DIMMING	
SOCKET TEST	
OTHER	

BIT NUMBER	15	14	13	12	11	10	9	8	7	6	5	4	3	2	1	0
CONTROL 1								SO	DX	D3	D2			F3#	F2#	F1
REPLY 1							LF2	LF1	DF	DR3	DR2	CF	MC	G3	G2	G1
REPLY 2							SD2-02361D1		SD1-02371J1				SD0-NOT USED			
REPLY 3									SD5-02371A1				SD4-NOT USED			
REPLY 4																

Revision	Description	Date
A	PLAN PRODUCED	05.02.96
B	SCOOT CHANGES WITH 02381	06.09.06

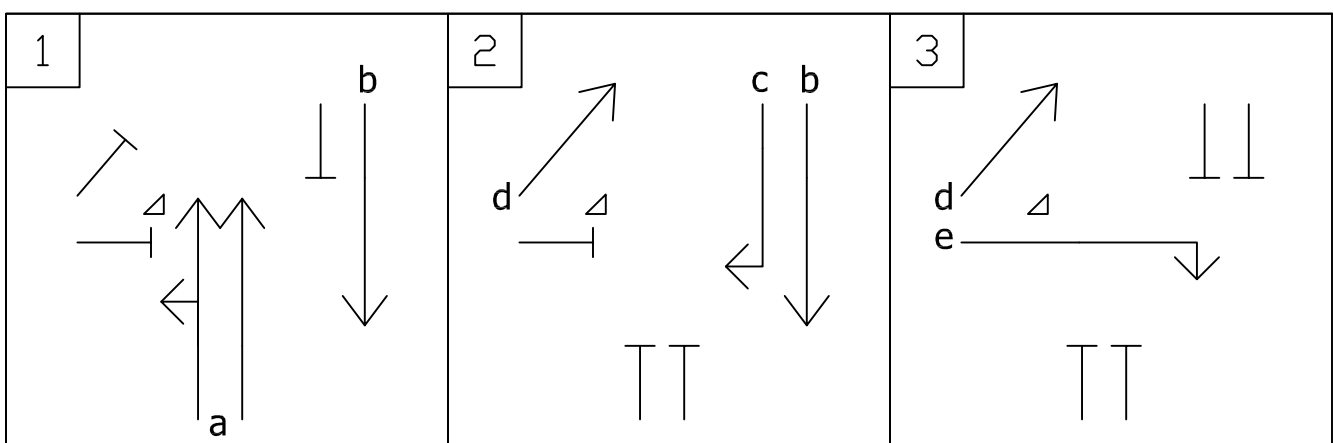

This map is based upon Ordnance Survey material with the permission of Ordnance Survey on behalf of the Controller of Her Majesty's Stationery Office © Crown copyright. Unauthorised reproduction infringes Crown copyright and may lead to prosecution or civil proceedings.
 Norfolk County Council.
 Licence No: 100019340. 2005

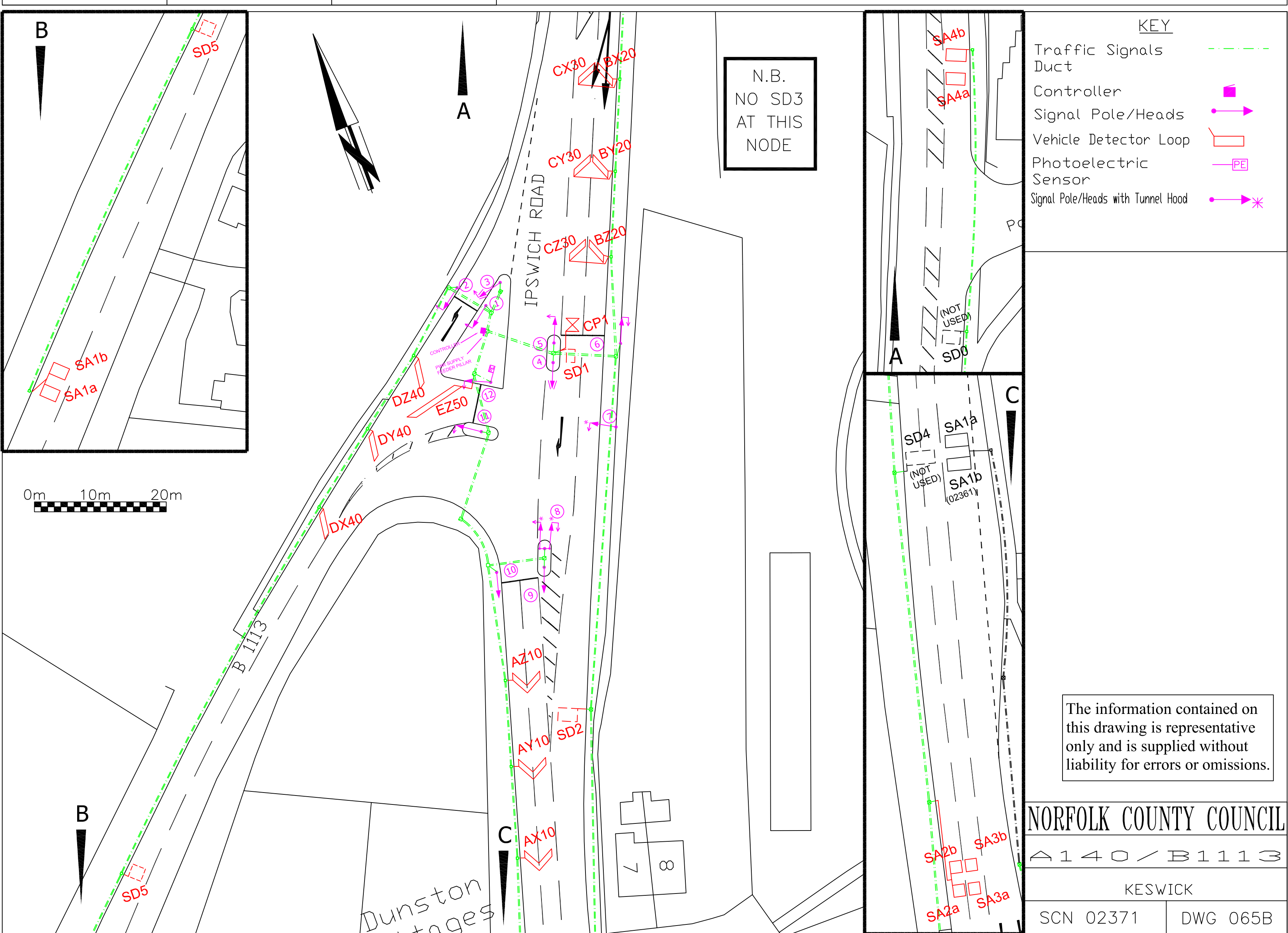

The information contained on this drawing is representative only and is supplied without liability for errors or omissions.

A - Signals switched ON 05-FEB-96

DATE : TUESDAY 13th JUNE 2017

WEATHER CONDITIONS: DRY

LOCATION : A140 IPSWICH ROAD / B1113, NORWICH

Table with columns: CAR, LGV, OGV1, OGV2, PSV, MBIKE, CYC, TOT HVs, VEH TOT, % HVs. Header: A140 IPSWICH ROAD (SOUTH) NORTHBOUND movement 1 (0700 - 0900)

Table with columns: CAR, LGV, OGV1, OGV2, PSV, MBIKE, CYC, TOT HVs, VEH TOT, % HVs. Header: A140 IPSWICH ROAD (NORTH) SOUTHBOUND movement 2 (0700 - 0900)

Table with columns: CAR, LGV, OGV1, OGV2, PSV, MBIKE, CYC, TOT HVs, VEH TOT, % HVs. Header: A140 IPSWICH ROAD (SOUTH) NORTHBOUND movement 1 (0900 - 1900)

Table with columns: CAR, LGV, OGV1, OGV2, PSV, MBIKE, CYC, TOT HVs, VEH TOT, % HVs. Header: A140 IPSWICH ROAD (NORTH) SOUTHBOUND movement 2 (0900 - 1900)

TOTAL FLOW INTO SURVEY SITE= 8381

TOTAL FLOW INTO SURVEY SITE= 8413

DIRECTIONAL TOTALS - MOVEMENTS 1 - 6

Table with 11 columns: CAR, LGV, OGV1, OGV2, PSV, MBIKE, CYC, TOT HVs, VEH TOT, % HVs. Rows include time intervals from 0700-0715 to 1800-1900. Total row: 7964, 1255, 242, 143, 126, 126, 6, 511, 9856, 5.2%

Table with 11 columns: CAR, LGV, OGV1, OGV2, PSV, MBIKE, CYC, TOT HVs, VEH TOT, % HVs. Rows include time intervals from 0700-0715 to 1800-1900. Total row: 8936, 1382, 244, 151, 157, 169, 38, 552, 11039, 5.0%

Table with 11 columns: CAR, LGV, OGV1, OGV2, PSV, MBIKE, CYC, TOT HVs, VEH TOT, % HVs. Rows include time intervals from 0700-0715 to 1800-1900. Total row: 3663, 428, 73, 13, 62, 68, 26, 148, 4307, 3.4%

Table with 11 columns: CAR, LGV, OGV1, OGV2, PSV, MBIKE, CYC, TOT HVs, VEH TOT, % HVs. Rows include time intervals from 0700-0800 to 1800-1900. Total row: 9856, 1255, 242, 143, 126, 126, 6, 511, 9856, 5.2%

Table with 11 columns: CAR, LGV, OGV1, OGV2, PSV, MBIKE, CYC, TOT HVs, VEH TOT, % HVs. Rows include time intervals from 0700-0800 to 1800-1900. Total row: 11039, 1382, 244, 151, 157, 169, 38, 552, 11039, 5.0%

Table with 11 columns: CAR, LGV, OGV1, OGV2, PSV, MBIKE, CYC, TOT HVs, VEH TOT, % HVs. Rows include time intervals from 0700-0800 to 1800-1900. Total row: 4307, 428, 73, 13, 62, 68, 26, 148, 4307, 3.4%

TOTAL FLOW INTO SURVEY SITE= 9856

TOTAL FLOW INTO SURVEY SITE= 11039

TOTAL FLOW INTO SURVEY SITE= 4307

GRAND TOTAL

ALL MOVEMENTS										
INTO SITE										
movements 1 - 6 (0700 - 0900)										
	CAR	LGV	OGV1	OGV2	PSV	MBIKE	CYC	TOT HVs	VEH TOT	% HVs
0700-0715	256	95	8	6	5	10	3	19	380	5.0%
0715-0730	367	87	15	8	8	7	4	31	492	6.3%
0730-0745	476	118	22	6	9	11	1	37	642	5.8%
0745-0800	572	88	13	11	7	10	2	31	701	4.4%
0800-0815	578	84	16	1	5	9	1	22	693	3.2%
0815-0830	544	84	16	7	11	7	0	34	669	5.1%
0830-0845	481	54	21	7	10	9	2	38	582	6.5%
0845-0900	489	64	19	12	7	7	2	38	598	6.4%
0900-0915	406	61	21	13	7	2	1	41	510	8.0%
0915-0930	423	88	15	9	5	5	3	29	545	5.3%
0930-0945	369	57	15	10	9	3	0	34	463	7.3%
0945-1000	367	46	21	8	10	3	0	39	455	8.6%
1000-1015	355	54	16	12	9	0	2	37	446	8.3%
1015-1030	320	48	10	13	5	5	0	28	401	7.0%
1030-1045	332	52	22	5	10	3	0	37	424	8.7%
1045-1100	363	60	19	6	6	7	1	31	461	6.7%
1100-1115	341	56	14	10	7	5	0	31	433	7.2%
1115-1130	357	66	16	10	6	3	1	32	458	7.0%
1130-1145	365	58	12	9	6	6	0	27	456	5.9%
1145-1200	348	47	7	9	5	4	0	21	420	5.0%
1200-1215	383	70	5	8	6	6	0	19	478	4.0%
1215-1230	377	61	12	11	6	3	1	29	470	6.2%
1230-1245	382	55	13	4	10	6	0	27	470	5.7%
1245-1300	395	69	10	8	7	2	1	25	491	5.1%
1300-1315	383	51	12	4	6	7	2	22	463	4.8%
1315-1330	397	52	8	11	7	6	0	26	481	5.4%
1330-1345	364	48	13	8	8	4	0	29	445	6.5%
1345-1400	333	61	21	8	8	5	0	37	436	8.5%
1400-1415	372	45	13	8	6	2	0	27	446	6.1%
1415-1430	342	50	15	12	5	6	0	32	430	7.4%
1430-1445	378	63	12	7	11	5	0	30	476	6.3%
1445-1500	374	52	11	4	6	4	0	21	451	4.7%
1500-1515	421	63	14	8	8	6	2	30	520	5.8%
1515-1530	425	69	7	5	4	7	0	16	517	3.1%
1530-1545	471	87	13	2	8	6	0	23	587	3.9%
1545-1600	433	86	13	1	9	4	2	23	546	4.2%
1600-1615	474	97	10	3	9	7	0	22	600	3.7%
1615-1630	529	83	6	4	12	10	1	22	644	3.4%
1630-1645	507	96	4	4	7	15	4	15	633	2.4%
1645-1700	569	65	4	6	7	10	3	17	661	2.6%
1700-1715	583	72	4	2	6	11	1	12	678	1.8%
1715-1730	586	65	3	0	5	10	2	8	669	1.2%
1730-1745	592	44	3	1	5	16	3	9	661	1.4%
1745-1800	560	55	3	2	9	25	5	14	654	2.1%
1800-1815	561	45	1	0	6	16	1	7	629	1.1%
1815-1830	482	34	2	1	6	23	4	9	548	1.6%
1830-1845	392	22	3	2	7	12	12	12	438	2.7%
1845-1900	389	38	6	1	4	13	3	11	451	2.4%
0700-1900	20563	3065	559	307	345	363	70	1211	25202	4.8%

	CAR	LGV	OGV1	OGV2	PSV	MBIKE	CYC	TOT HVs	VEH TOT	% HVs
0700-0800	1671	388	58	31	29	38	10	118	2215	5.3%
0715-0815	1993	377	66	26	29	37	8	121	2528	4.8%
0730-0830	2170	374	67	25	32	37	4	124	2705	4.6%
0745-0845	2175	310	66	26	33	35	5	125	2645	4.7%
0800-0900	2092	286	72	27	33	32	5	132	2542	5.2%
0815-0915	1920	263	77	39	35	25	5	151	2359	6.4%
0830-0930	1799	267	76	41	29	23	8	146	2235	6.5%
0845-0945	1687	270	70	44	28	17	6	142	2116	6.7%
0900-1000	1565	252	72	40	31	13	4	143	1973	7.2%
0915-1015	1514	245	67	39	33	11	5	139	1909	7.3%
0930-1030	1411	205	62	43	33	11	2	138	1765	7.8%
0945-1045	1374	200	69	38	34	11	2	141	1726	8.2%
1000-1100	1370	214	67	36	30	15	3	133	1732	7.7%
1015-1115	1356	216	65	34	28	20	1	127	1719	7.4%
1030-1130	1393	234	71	31	29	18	2	131	1776	7.4%
1045-1145	1426	240	61	35	25	21	2	121	1808	6.7%
1100-1200	1411	227	49	38	24	18	1	111	1767	6.3%
1115-1215	1453	241	40	36	23	19	1	99	1812	5.5%
1130-1230	1473	236	36	37	23	19	1	96	1824	5.3%
1145-1245	1490	233	37	32	27	19	1	96	1838	5.2%
1200-1300	1537	255	40	31	29	17	2	100	1909	5.2%
1215-1315	1537	236	47	27	29	18	4	103	1894	5.4%
1230-1330	1557	227	43	27	30	21	3	100	1905	5.2%
1245-1345	1539	220	43	31	28	19	3	102	1880	5.4%
1300-1400	1477	212	54	31	29	22	2	114	1825	6.2%
1315-1415	1466	206	55	35	29	17	0	119	1808	6.6%
1330-1430	1411	204	62	36	27	17	0	125	1757	7.1%
1345-1445	1425	219	61	35	30	18	0	126	1788	7.0%
1400-1500	1466	210	51	31	28	17	0	110	1803	6.1%
1415-1515	1515	228	52	31	30	21	2	113	1877	6.0%
1430-1530	1598	247	44	24	29	22	2	97	1964	4.9%
1445-1545	1691	271	45	19	26	23	2	90	2075	4.3%
1500-1600	1750	305	47	16	29	23	4	92	2170	4.2%
1515-1615	1803	339	43	11	30	24	2	84	2250	3.7%
1530-1630	1907	353	42	10	38	27	3	90	2377	3.8%
1545-1645	1943	362	33	12	37	36	7	82	2423	3.4%
1600-1700	2079	341	24	17	35	42	8	76	2538	3.0%
1615-1715	2188	316	18	16	32	46	9	66	2616	2.5%
1630-1730	2245	298	15	12	25	46	10	52	2641	2.0%
1645-1745	2330	246	14	9	23	47	9	46	2669	1.7%
1700-1800	2321	236	13	5	25	62	11	43	2662	1.6%
1715-1815	2299	209	10	3	25	67	11	38	2613	1.5%
1730-1830	2195	178	9	4	26	80	13	39	2492	1.6%
1745-1845	1995	156	9	5	28	76	22	42	2269	1.9%
1800-1900	1824	139	12	4	23	64	20	39	2066	1.9%

DATE : TUESDAY 13th JUNE 2017



WEATHER CONDITIONS: DRY

LOCATION : A140 IPSWICH ROAD / B1113, NORWICH

TIME	ARM 1 A140 (N)	
	LANE 1	LANE 2

07:00	9	4
07:05	7	3
07:10	8	3
07:15	10	1
07:20	15	4
07:25	6	3
07:30	19	4
07:35	18	5
07:40	15	9
07:45	22	4
07:50	21	7
07:55	12	9
08:00	6	2
08:05	12	4
08:10	4	4
08:15	14	7
08:20	20	3
08:25	18	9
08:30	12	10
08:35	18	6
08:40	7	6
08:45	14	6
08:50	13	3
08:55	4	6
09:00	4	5
09:05	4	3
09:10	5	6
09:15	6	4
09:20	1	5
09:25	2	3
09:30	1	3
09:35	2	5
09:40	3	5
09:45	11	3
09:50	11	4
09:55	5	4
10:00	6	4
10:05	5	5
10:10	8	3
10:15	13	4
10:20	6	4
10:25	5	5
10:30	3	4
10:35	3	5
10:40	6	7
10:45	12	8
10:50	11	3
10:55	8	2
11:00	15	3
11:05	4	4
11:10	10	6
11:15	12	4
11:20	9	5
11:25	8	5
11:30	10	3
11:35	5	6
11:40	11	5
11:45	10	3
11:50	8	3
11:55	5	4
12:00	16	4
12:05	11	7
12:10	15	5
12:15	14	3
12:20	8	7
12:25	7	4
12:30	10	6
12:35	22	5
12:40	8	5
12:45	14	11
12:50	9	7
12:55	4	4
13:00	9	3

TIME	ARM 2 A140 (S)	
	LANE 1	LANE 2

6	6
9	7
7	8
8	8
13	9
14	11
8	5
23	17
25	24
18	14
20	12
36	36
38	40
40	38
38	39
36	36
26	26
22	16
25	16
13	13
14	14
15	14
14	13
23	20
15	10
8	5
12	15
10	9
8	9
12	7
10	9
9	8
7	5
10	4
13	6
9	4
6	4
7	6
9	6
9	4
5	5
7	3
8	6
11	5
8	5
8	7
8	11
16	7
10	3
9	5
13	5
7	4
6	2
6	3
4	3
13	4
9	4
11	5
10	6
6	5
12	11
7	5
12	6
18	7
9	3
13	6
8	9
12	4
6	5
12	4
9	6
7	4
11	6

TIME	ARM 3 B1113 (W)		
	LANE 1	LANE 2	LANE 3

3	2	1
3	2	1
2	2	2
10	2	2
7	1	2
14	1	2
7	2	2
8	2	3
14	1	2
14	2	2
16	2	2
14	2	2
16	1	1
15	3	3
18	2	2
14	3	2
16	1	2
14	2	2
12	2	3
9	1	3
9	2	3
14	1	3
10	2	2
13	2	2
5	3	3
14	2	2
12	2	2
4	2	2
10	3	2
8	1	1
3	2	2
11	2	1
2	2	2
11	1	1
7	2	2
3	2	2
4	1	2
4	2	2
10	1	3
3	1	2
3	2	2
5	2	1
9	3	2
2	2	1
4	1	2
14	1	1
2	1	1
2	1	3
4	2	2
2	3	1
14	1	1
6	1	1
8	1	2
3	2	1
9	2	1
14	1	2
13	1	2
8	1	2
7	2	2
2	2	1
6	2	2
5	1	2
4	2	2
2	2	1
11	1	1
11	2	1
6	1	2
6	2	0

TIME	ARM 1 A140 (N)	
	LANE 1	LANE 2

13:05	19	7
13:10	7	5
13:15	8	4
13:20	9	7
13:25	16	11
13:30	7	5
13:35	12	5
13:40	10	9
13:45	5	7
13:50	3	5
13:55	9	3
14:00	9	4
14:05	12	6
14:10	10	6
14:15	9	5
14:20	16	3
14:25	7	4
14:30	12	5
14:35	5	5
14:40	17	8
14:45	11	6
14:50	16	7
14:55	11	5
15:00	17	7
15:05	21	8
15:10	8	8
15:15	20	6
15:20	16	4
15:25	4	4
15:30	21	6
15:35	21	7
15:40	7	11
15:45	10	6
15:50	11	10
15:55	18	7
16:00	7	4
16:05	21	8
16:10	21	10
16:15	16	7
16:20	2	7
16:25	21	11
16:30	17	12
16:35	18	15
16:40	18	15
16:45	8	12
16:50	12	13
16:55	13	10
17:00	12	11
17:05	9	13
17:10	18	11
17:15	26	15
17:20	12	13
17:25	3	4
17:30	7	13
17:35	6	7
17:40	20	8
17:45	9	14
17:50	12	15
17:55	6	18
18:00	10	10
18:05	8	8
18:10	12	7
18:15	8	13
18:20	5	4
18:25	4	6
18:30	6	7
18:35	6	6
18:40	6	7
18:45	4	8
18:50	8	8
18:55	8	3
19:00	0	0

TIME	ARM 2 A140 (S)	
	LANE 1	LANE 2

9	6
14	2
7	4
12	6
13	4
8	6
10	5
10	3
15	3
9	3
8	2
6	4
14	5
9	4
8	5
13	10
7	4
14	7
11	7
10	5
11	8
5	2
7	5
12	5
7	5
12	5
8	5
11	7
7	6
13	10
13	5
12	7
10	8
15	8
12	5
7	5
18	6
13	10
10	6
11	6
14	7
13	9
10	12
11	13
16	8
7	8
15	7
10	6
7	6
10	10
13	16
14	10
20	13
14	6
10	6
14	9
17	15
12	8
12	10
8	7
14	8
17	8
10	10
11	8
10	7
15	6
4	2
10	6
8	10
5	3
5	4
0	0

TIME	ARM 3 B1113 (W)		
	LANE 1	LANE 2	LANE 3

8	2	1
3	2	1
5	2	1
7	2	2
6	2	1
10	2	1
4	2	5
4	2	2
6	1	2
5	2	0
3	1	1
13	2	2
13	2	2
3	2	2
6	2	1
2	1	1
3	1	1
5	2	2
2	1	2
5	1	2
5	2	2
6	1	2
3	1	2
5	1	2
14	2	2
12	2	2
8	2	2
3	1	2
8	2	1
4	2	1
6	1	2
7	2	2
4	2	2
14	2	2
8	2	2
14	2	2
14	2	2
14	2	2
8	2	2
14	2	2
2	2	2
14	2	2
6	2	1
12	2	2
11	2	2
4	2	2
2	2	2
14	2	2
6	2	2
14	2	2
14	2	2
11	2	2
5	2	2
3	2	2
5	2	2
5	2	2
6	2	2
10	2	2
1	2	2
3	1	2
2	1	2
4	1	1
4	2	1
6	1	2
2	2	2
0	0	0

**A140 / B1113 Signalised Junction Traffic Flows
2017 Base**

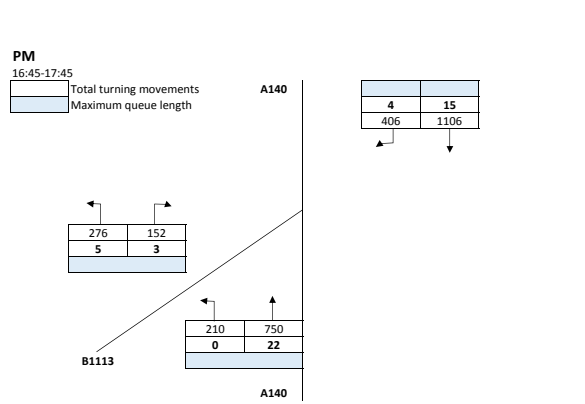
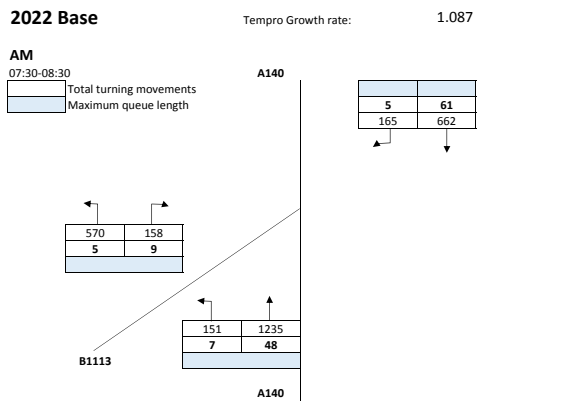
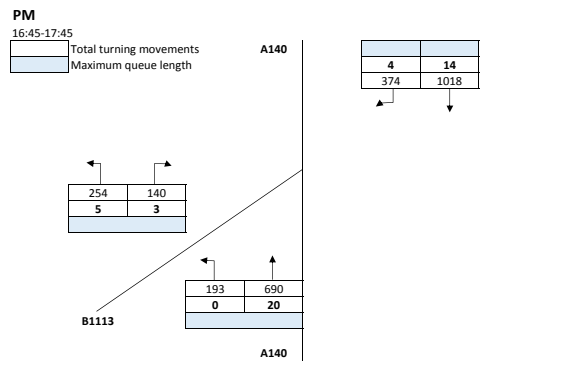
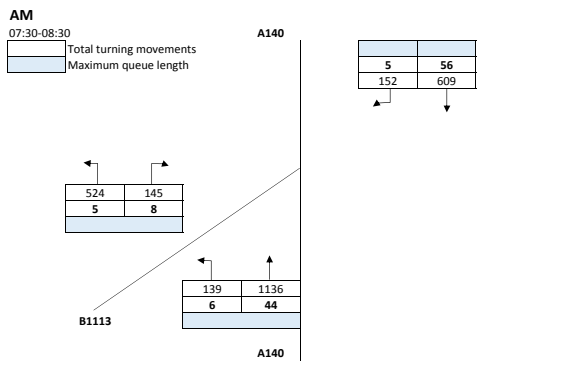

Total Construction (100% Scenario)

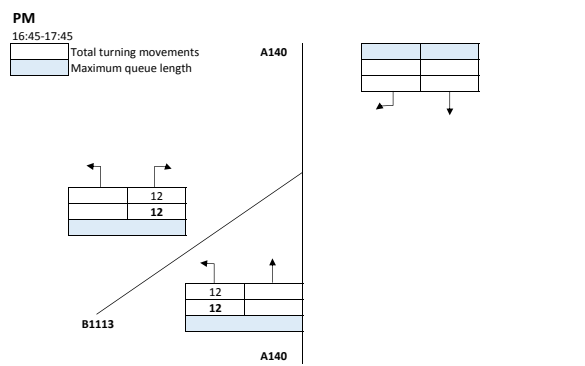
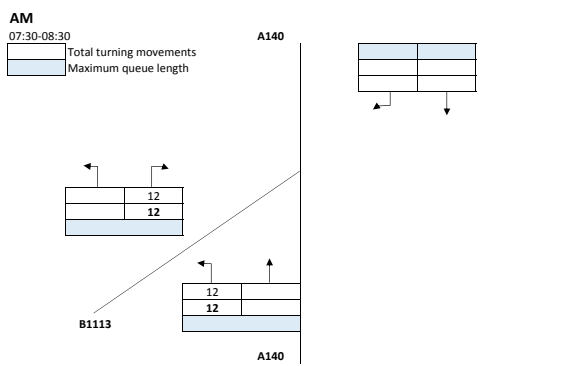

2022 Base + Construction (100% Scenario)

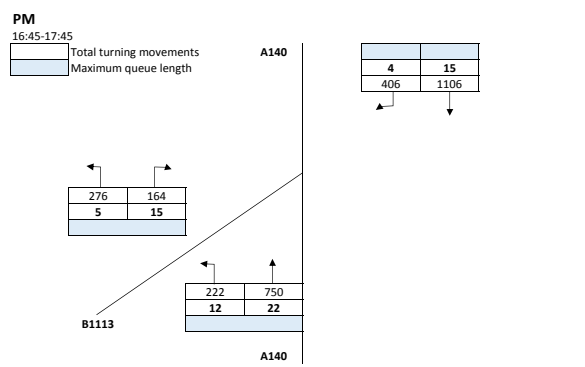
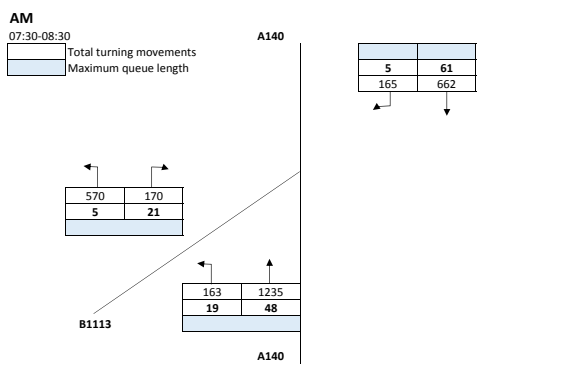

Construction (Sensitivity - 200% Scenario)

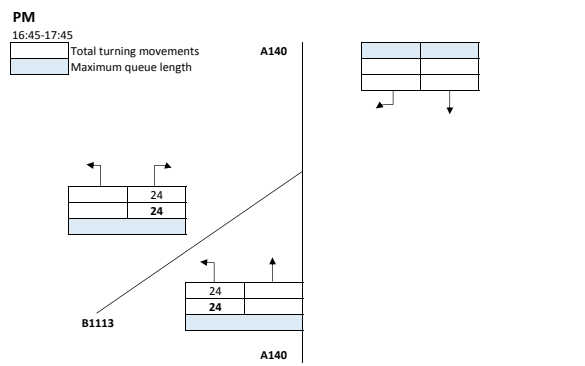
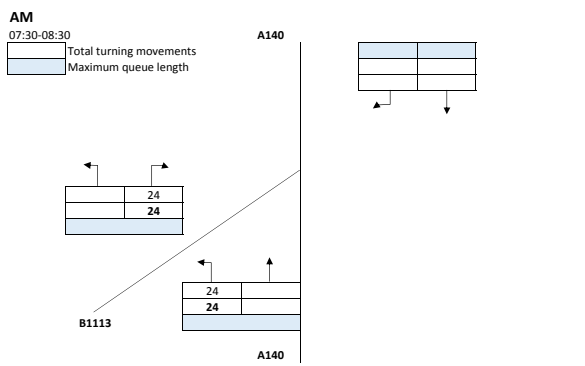

2022 Base + Construction (Sensitivity - 200% Scenario)

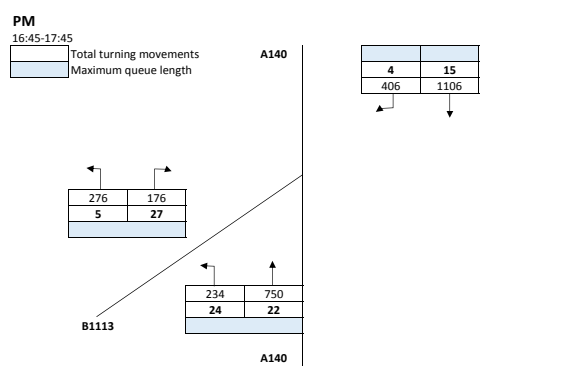
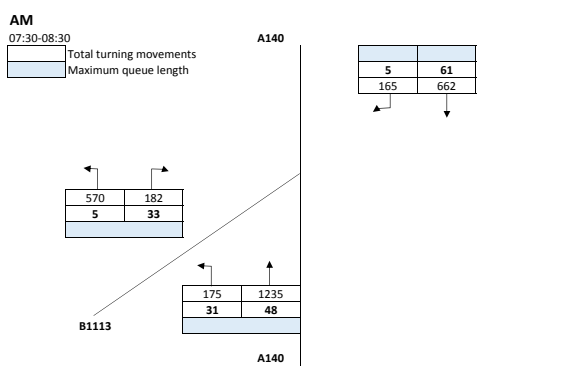

Appendix E LinSig Full Input Data and Results

Full Input Data And Results
Full Input Data And Results

User and Project Details

Project:	JNY8772 Hornsea Project 3
Title:	Existing junction model
Location:	
File name:	A140 - B1113 Junction Revised 06-04-18.lsg3x
Author:	Paul Warner
Company:	RPS
Address:	
Notes:	

Network Layout Diagram

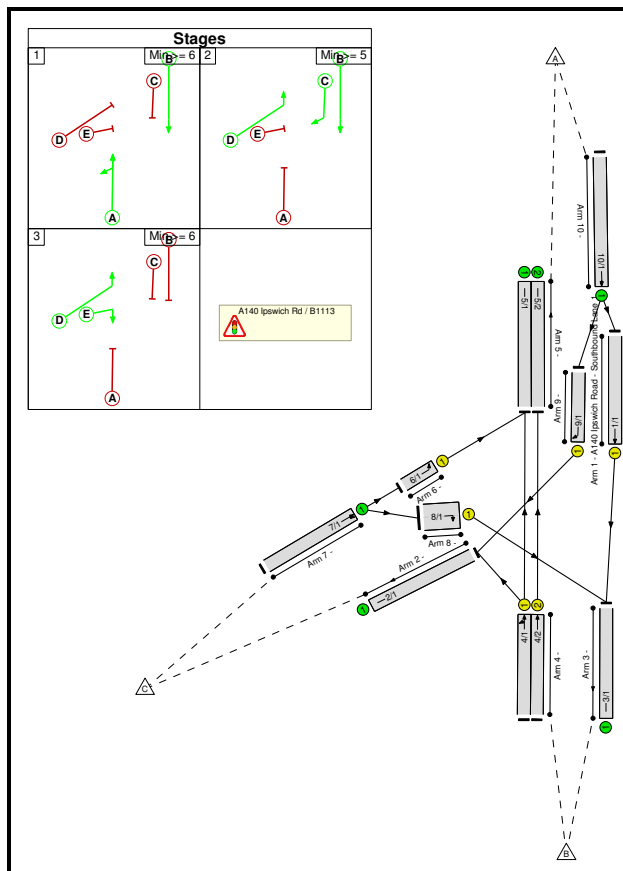

Phase Diagram

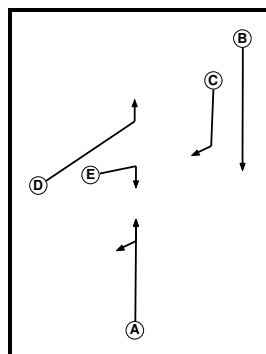

Full Input Data And Results

Phase Input Data

Phase Name	Phase Type	Assoc. Phase	Street Min	Cont Min
A	Traffic		7	7
B	Traffic		7	7
C	Traffic		7	7
D	Traffic		7	7
E	Traffic		7	7

Phase Intergreens Matrix

		Starting Phase				
		A	B	C	D	E
Terminating Phase	A	-	5	7	6	
	B	-	-	-	5	
	C	6	-	-	-	6
	D	5	-	-	-	-
	E	5	6	6	-	-

Phases in Stage

Stage No.	Phases in Stage
1	A B
2	B C D
3	D E

Stage Diagram

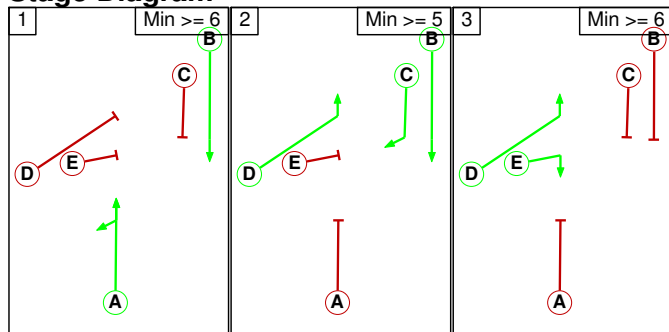

Phase Delays

Term. Stage	Start Stage	Phase	Type	Value	Cont value
There are no Phase Delays defined					

Prohibited Stage Change

		To Stage		
		1	2	3
From Stage	1	-	7	7
	2	6	-	6
	3	6	6	-

Full Input Data And Results

Give-Way Lane Input Data

Junction: A140 Ipswich Rd / B1113

There are no Opposed Lanes in this Junction

Full Input Data And Results

Lane Input Data

Junction: A140 Ipswich Rd / B1113												
Lane	Lane Type	Phases	Start Disp.	End Disp.	Physical Length (PCU)	Sat Flow Type	Def User Saturation Flow (PCU/Hr)	Lane Width (m)	Gradient	Nearside Lane	Turns	Turning Radius (m)
1/1 (A140 Ipswich Road - Southbound Lane 1)	U	B	2	3	10.7	User	1500	-	-	-	-	-
2/1	U		2	3	60.0	Inf	-	-	-	-	-	-
3/1	U		2	3	60.0	Inf	-	-	-	-	-	-
4/1	U	A	2	3	50.2	User	1660	-	-	-	-	-
4/2	U	A	2	3	50.2	User	1610	-	-	-	-	-
5/1	U		2	3	60.0	Inf	-	-	-	-	-	-
5/2	U		2	3	60.0	Inf	-	-	-	-	-	-
6/1	U	D	2	3	5.2	User	1295	-	-	-	-	-
7/1	U		2	3	47.0	Inf	-	-	-	-	-	-
8/1	U	E	2	3	5.2	User	950	-	-	-	-	-
9/1	U	C	2	3	10.7	User	795	-	-	-	-	-
10/1	U		2	3	59.1	Inf	-	-	-	-	-	-

Traffic Flow Groups

Flow Group	Start Time	End Time	Duration	Formula
1: '2017 AM Peak Hour Existing'	07:30	08:30	01:00	
2: '2017 PM Peak Hour Existing'	16:45	17:45	01:00	
3: '2022 AM Peak Hour Growthed'	07:30	08:30	01:00	
4: '2022 PM Peak Hour Growthed'	16:45	17:45	01:00	
5: '2022 AM Peak Hour + Proposed Development'	07:30	08:30	01:00	
6: '2022 PM Peak Hour + Proposed Development'	16:45	17:45	01:00	
7: '2022 AM Peak Hour + Proposed Development - Sensitivity Test'	07:30	08:30	01:00	
8: '2022 PM Peak Hour + Proposed Development - Sensitivity Test'	16:45	17:45	01:00	

Full Input Data And Results

Scenario 1: '2017 Existing AM Peak' (FG1: '2017 AM Peak Hour Existing', Plan 1: 'Network Control Plan 1')

Traffic Flows, Desired

Desired Flow :

		Destination			
		A	B	C	Tot.
Origin	A	0	650	154	804
	B	1163	0	141	1304
	C	524	150	0	674
	Tot.	1687	800	295	2782

Traffic Lane Flows

Lane	Scenario 1: 2017 Existing AM Peak
Junction: A140 Ipswich Rd / B1113	
1/1	650
2/1	295
3/1	800
4/1	664
4/2	640
5/1	1047
5/2	640
6/1	524
7/1	674
8/1	150
9/1	154
10/1	804

Lane Saturation Flows

Junction: A140 Ipswich Rd / B1113								
Lane	Lane Width (m)	Gradient	Nearside Lane	Allowed Turns	Turning Radius (m)	Turning Prop.	Sat Flow (PCU/Hr)	Flared Sat Flow (PCU/Hr)
1/1 (A140 Ipswich Road - Southbound Lane 1 Lane 1)							1065	1065
2/1							Inf	Inf
3/1							Inf	Inf
4/1							1660	1660
4/2							1610	1610
5/1							Inf	Inf
5/2							Inf	Inf
6/1							1295	1295
7/1							Inf	Inf
8/1							950	950
9/1							795	795
10/1							Inf	Inf

Scenario 2: '2017 Existing PM Peak' (FG2: '2017 PM Peak Hour Existing', Plan 1: 'Network Control Plan 1')

Traffic Flows, Desired

Desired Flow :

	Destination				
	A	B	C	Tot.	
Origin	A	0	1023	372	1395
	B	706	0	189	895
	C	253	141	0	394
	Tot.	959	1164	561	2684

Full Input Data And Results

Traffic Lane Flows

Lane	Scenario 2: 2017 Existing PM Peak
Junction: A140 Ipswich Rd / B1113	
1/1	1023
2/1	561
3/1	1164
4/1	189
4/2	706
5/1	253
5/2	706
6/1	253
7/1	394
8/1	141
9/1	372
10/1	1395

Lane Saturation Flows

Junction: A140 Ipswich Rd / B1113								
Lane	Lane Width (m)	Gradient	Nearside Lane	Allowed Turns	Turning Radius (m)	Turning Prop.	Sat Flow (PCU/Hr)	Flared Sat Flow (PCU/Hr)
1/1 (A140 Ipswich Road - Southbound Lane 1 Lane 1)	This lane uses a directly entered Saturation Flow						2010	2010
2/1	Infinite Saturation Flow						Inf	Inf
3/1	Infinite Saturation Flow						Inf	Inf
4/1	This lane uses a directly entered Saturation Flow						460	460
4/2	This lane uses a directly entered Saturation Flow						2600	2600
5/1	Infinite Saturation Flow						Inf	Inf
5/2	Infinite Saturation Flow						Inf	Inf
6/1	This lane uses a directly entered Saturation Flow						620	620
7/1	Infinite Saturation Flow						Inf	Inf
8/1	This lane uses a directly entered Saturation Flow						890	890
9/1	This lane uses a directly entered Saturation Flow						1835	1835
10/1	Infinite Saturation Flow						Inf	Inf

Full Input Data And Results

Scenario 3: '2022 Growthed AM Peak' (FG3: '2022 AM Peak Hour Growthed', Plan 1: 'Network Control Plan 1')

Traffic Flows, Desired

Desired Flow :

		Destination			
		A	B	C	Tot.
Origin	A	0	706	167	873
	B	1264	0	153	1417
	C	569	163	0	732
	Tot.	1833	869	320	3022

Traffic Lane Flows

Lane	Scenario 3: 2022 Growthed AM Peak
Junction: A140 Ipswich Rd / B1113	
1/1	706
2/1	320
3/1	869
4/1	720
4/2	697
5/1	1136
5/2	697
6/1	569
7/1	732
8/1	163
9/1	167
10/1	873

Full Input Data And Results

Lane Saturation Flows

Junction: A140 Ipswich Rd / B1113								
Lane	Lane Width (m)	Gradient	Nearside Lane	Allowed Turns	Turning Radius (m)	Turning Prop.	Sat Flow (PCU/Hr)	Flared Sat Flow (PCU/Hr)
1/1 (A140 Ipswich Road - Southbound Lane 1 Lane 1)							1065	1065
2/1							Inf	Inf
3/1							Inf	Inf
4/1							1660	1660
4/2							1610	1610
5/1							Inf	Inf
5/2							Inf	Inf
6/1							1295	1295
7/1							Inf	Inf
8/1							950	950
9/1							795	795
10/1							Inf	Inf

Scenario 4: '2022 Growthed PM Peak' (FG4: '2022 PM Peak Hour Growthed', Plan 1: 'Network Control Plan 1')

Traffic Flows, Desired

Desired Flow :

	Destination				
	A	B	C	Tot.	
Origin	A	0	1112	404	1516
	B	767	0	205	972
	C	275	153	0	428
	Tot.	1042	1265	609	2916

Full Input Data And Results

Traffic Lane Flows

Lane	Scenario 4: 2022 Growthed PM Peak
Junction: A140 Ipswich Rd / B1113	
1/1	1112
2/1	609
3/1	1265
4/1	205
4/2	767
5/1	275
5/2	767
6/1	275
7/1	428
8/1	153
9/1	404
10/1	1516

Lane Saturation Flows

Junction: A140 Ipswich Rd / B1113								
Lane	Lane Width (m)	Gradient	Nearside Lane	Allowed Turns	Turning Radius (m)	Turning Prop.	Sat Flow (PCU/Hr)	Flared Sat Flow (PCU/Hr)
1/1 (A140 Ipswich Road - Southbound Lane 1 Lane 1)	This lane uses a directly entered Saturation Flow						2010	2010
2/1	Infinite Saturation Flow						Inf	Inf
3/1	Infinite Saturation Flow						Inf	Inf
4/1	This lane uses a directly entered Saturation Flow						460	460
4/2	This lane uses a directly entered Saturation Flow						2600	2600
5/1	Infinite Saturation Flow						Inf	Inf
5/2	Infinite Saturation Flow						Inf	Inf
6/1	This lane uses a directly entered Saturation Flow						620	620
7/1	Infinite Saturation Flow						Inf	Inf
8/1	This lane uses a directly entered Saturation Flow						890	890
9/1	This lane uses a directly entered Saturation Flow						1835	1835
10/1	Infinite Saturation Flow						Inf	Inf

Full Input Data And Results

Scenario 5: '2022 AM Peak + Proposed Development' (FG5: '2022 AM Peak Hour + Proposed Development', Plan 1: 'Network Control Plan 1')

Traffic Flows, Desired

Desired Flow :

	Destination				
		A	B	C	Tot.
Origin	A	0	706	167	873
	B	1264	0	181	1445
	C	569	191	0	760
	Tot.	1833	897	348	3078

Traffic Lane Flows

Lane	Scenario 5: 2022 AM Peak + Proposed Development
Junction: A140 Ipswich Rd / B1113	
1/1	706
2/1	348
3/1	897
4/1	734
4/2	711
5/1	1122
5/2	711
6/1	569
7/1	760
8/1	191
9/1	167
10/1	873

Full Input Data And Results

Lane Saturation Flows

Junction: A140 Ipswich Rd / B1113								
Lane	Lane Width (m)	Gradient	Nearside Lane	Allowed Turns	Turning Radius (m)	Turning Prop.	Sat Flow (PCU/Hr)	Flared Sat Flow (PCU/Hr)
1/1 (A140 Ipswich Road - Southbound Lane 1 Lane 1)	This lane uses a directly entered Saturation Flow						1065	1065
2/1	Infinite Saturation Flow						Inf	Inf
3/1	Infinite Saturation Flow						Inf	Inf
4/1	This lane uses a directly entered Saturation Flow						1660	1660
4/2	This lane uses a directly entered Saturation Flow						1610	1610
5/1	Infinite Saturation Flow						Inf	Inf
5/2	Infinite Saturation Flow						Inf	Inf
6/1	This lane uses a directly entered Saturation Flow						1295	1295
7/1	Infinite Saturation Flow						Inf	Inf
8/1	This lane uses a directly entered Saturation Flow						950	950
9/1	This lane uses a directly entered Saturation Flow						795	795
10/1	Infinite Saturation Flow						Inf	Inf

Scenario 6: '2022 PM Peak + Proposed Development' (FG6: '2022 PM Peak Hour + Proposed Development', Plan 1: 'Network Control Plan 1')

Traffic Flows, Desired

Desired Flow :

	Destination				
		A	B	C	Tot.
Origin	A	0	1112	404	1516
	B	767	0	233	1000
	C	275	181	0	456
	Tot.	1042	1293	637	2972

Full Input Data And Results

Traffic Lane Flows

Lane	Scenario 6: 2022 PM Peak + Proposed Development
Junction: A140 Ipswich Rd / B1113	
1/1	1112
2/1	637
3/1	1293
4/1	233
4/2	767
5/1	275
5/2	767
6/1	275
7/1	456
8/1	181
9/1	404
10/1	1516

Lane Saturation Flows

Junction: A140 Ipswich Rd / B1113								
Lane	Lane Width (m)	Gradient	Nearside Lane	Allowed Turns	Turning Radius (m)	Turning Prop.	Sat Flow (PCU/Hr)	Flared Sat Flow (PCU/Hr)
1/1 (A140 Ipswich Road - Southbound Lane 1 Lane 1)	This lane uses a directly entered Saturation Flow						2010	2010
2/1	Infinite Saturation Flow						Inf	Inf
3/1	Infinite Saturation Flow						Inf	Inf
4/1	This lane uses a directly entered Saturation Flow						460	460
4/2	This lane uses a directly entered Saturation Flow						2600	2600
5/1	Infinite Saturation Flow						Inf	Inf
5/2	Infinite Saturation Flow						Inf	Inf
6/1	This lane uses a directly entered Saturation Flow						620	620
7/1	Infinite Saturation Flow						Inf	Inf
8/1	This lane uses a directly entered Saturation Flow						890	890
9/1	This lane uses a directly entered Saturation Flow						1835	1835
10/1	Infinite Saturation Flow						Inf	Inf

Full Input Data And Results

Scenario 7: '2022 AM Peak + Proposed Development - Sensitivity Test' (FG7: '2022 AM Peak Hour + Proposed Development - Sensitivity Test', Plan 1: 'Network Control Plan 1')

Traffic Flows, Desired

Desired Flow :

	Destination				
		A	B	C	Tot.
Origin	A	0	706	167	873
	B	1264	0	208	1472
	C	569	218	0	787
	Tot.	1833	924	375	3132

Traffic Lane Flows

Lane	Scenario 7: 2022 AM Peak + Proposed Development - Sensitivity Test
Junction: A140 Ipswich Rd / B1113	
1/1	706
2/1	375
3/1	924
4/1	747
4/2	725
5/1	1108
5/2	725
6/1	569
7/1	787
8/1	218
9/1	167
10/1	873

Full Input Data And Results

Lane Saturation Flows

Junction: A140 Ipswich Rd / B1113								
Lane	Lane Width (m)	Gradient	Nearside Lane	Allowed Turns	Turning Radius (m)	Turning Prop.	Sat Flow (PCU/Hr)	Flared Sat Flow (PCU/Hr)
1/1 (A140 Ipswich Road - Southbound Lane 1 Lane 1)	This lane uses a directly entered Saturation Flow						1065	1065
2/1	Infinite Saturation Flow						Inf	Inf
3/1	Infinite Saturation Flow						Inf	Inf
4/1	This lane uses a directly entered Saturation Flow						1660	1660
4/2	This lane uses a directly entered Saturation Flow						1610	1610
5/1	Infinite Saturation Flow						Inf	Inf
5/2	Infinite Saturation Flow						Inf	Inf
6/1	This lane uses a directly entered Saturation Flow						1295	1295
7/1	Infinite Saturation Flow						Inf	Inf
8/1	This lane uses a directly entered Saturation Flow						950	950
9/1	This lane uses a directly entered Saturation Flow						795	795
10/1	Infinite Saturation Flow						Inf	Inf

Scenario 8: '2022 PM Peak + Proposed Development - Sensitivity Test' (FG8: '2022 PM Peak Hour + Proposed Development - Sensitivity Test', Plan 1: 'Network Control Plan 1')

Traffic Flows, Desired

Desired Flow :

	Destination				
		A	B	C	Tot.
Origin	A	0	1112	404	1516
	B	767	0	260	1027
	C	275	208	0	483
	Tot.	1042	1320	664	3026

Full Input Data And Results

Traffic Lane Flows

Lane	Scenario 8: 2022 PM Peak + Proposed Development - Sensitivity Test
Junction: A140 Ipswich Rd / B1113	
1/1	1112
2/1	664
3/1	1320
4/1	260
4/2	767
5/1	275
5/2	767
6/1	275
7/1	483
8/1	208
9/1	404
10/1	1516

Lane Saturation Flows

Junction: A140 Ipswich Rd / B1113								
Lane	Lane Width (m)	Gradient	Nearside Lane	Allowed Turns	Turning Radius (m)	Turning Prop.	Sat Flow (PCU/Hr)	Flared Sat Flow (PCU/Hr)
1/1 (A140 Ipswich Road - Southbound Lane 1 Lane 1)							2010	2010
2/1							Inf	Inf
3/1							Inf	Inf
4/1							460	460
4/2							2600	2600
5/1							Inf	Inf
5/2							Inf	Inf
6/1							620	620
7/1							Inf	Inf
8/1							890	890
9/1							1835	1835
10/1							Inf	Inf

Full Input Data And Results

Scenario 9: 'Copy of 2022 AM Peak + Proposed Development' (FG5: '2022 AM Peak Hour + Proposed Development', Plan 1: 'Network Control Plan 1')

Traffic Flows, Desired

Desired Flow :

	Destination				
		A	B	C	Tot.
Origin	A	0	706	167	873
	B	1264	0	181	1445
	C	569	191	0	760
	Tot.	1833	897	348	3078

Traffic Lane Flows

Lane	Scenario 9: Copy of 2022 AM Peak + Proposed Development
Junction: A140 Ipswich Rd / B1113	
1/1	706
2/1	348
3/1	897
4/1	734
4/2	711
5/1	1122
5/2	711
6/1	569
7/1	760
8/1	191
9/1	167
10/1	873

Full Input Data And Results

Lane Saturation Flows

Junction: A140 Ipswich Rd / B1113									
Lane	Lane Width (m)	Gradient	Nearside Lane	Allowed Turns	Turning Radius (m)	Turning Prop.	Sat Flow (PCU/Hr)	Flared Sat Flow (PCU/Hr)	
1/1 (A140 Ipswich Road - Southbound Lane 1 Lane 1)	This lane uses a directly entered Saturation Flow							1065	1065
2/1	Infinite Saturation Flow							Inf	Inf
3/1	Infinite Saturation Flow							Inf	Inf
4/1	This lane uses a directly entered Saturation Flow							1660	1660
4/2	This lane uses a directly entered Saturation Flow							1610	1610
5/1	Infinite Saturation Flow							Inf	Inf
5/2	Infinite Saturation Flow							Inf	Inf
6/1	This lane uses a directly entered Saturation Flow							1295	1295
7/1	Infinite Saturation Flow							Inf	Inf
8/1	This lane uses a directly entered Saturation Flow							950	950
9/1	This lane uses a directly entered Saturation Flow							795	795
10/1	Infinite Saturation Flow							Inf	Inf

Scenario 10: 'Copy of 2022 PM Peak + Proposed Development' (FG6: '2022 PM Peak Hour + Proposed Development', Plan 1: 'Network Control Plan 1')

Traffic Flows, Desired

Desired Flow :

	Destination				
		A	B	C	Tot.
Origin	A	0	1112	404	1516
	B	767	0	233	1000
	C	275	181	0	456
	Tot.	1042	1293	637	2972

Full Input Data And Results

Traffic Lane Flows

Lane	Scenario 10: Copy of 2022 PM Peak + Proposed Development
Junction: A140 Ipswich Rd / B1113	
1/1	1112
2/1	637
3/1	1293
4/1	233
4/2	767
5/1	275
5/2	767
6/1	275
7/1	456
8/1	181
9/1	404
10/1	1516

Lane Saturation Flows

Junction: A140 Ipswich Rd / B1113								
Lane	Lane Width (m)	Gradient	Nearside Lane	Allowed Turns	Turning Radius (m)	Turning Prop.	Sat Flow (PCU/Hr)	Flared Sat Flow (PCU/Hr)
1/1 (A140 Ipswich Road - Southbound Lane 1 Lane 1)	This lane uses a directly entered Saturation Flow						2010	2010
2/1	Infinite Saturation Flow						Inf	Inf
3/1	Infinite Saturation Flow						Inf	Inf
4/1	This lane uses a directly entered Saturation Flow						460	460
4/2	This lane uses a directly entered Saturation Flow						2600	2600
5/1	Infinite Saturation Flow						Inf	Inf
5/2	Infinite Saturation Flow						Inf	Inf
6/1	This lane uses a directly entered Saturation Flow						620	620
7/1	Infinite Saturation Flow						Inf	Inf
8/1	This lane uses a directly entered Saturation Flow						890	890
9/1	This lane uses a directly entered Saturation Flow						1835	1835
10/1	Infinite Saturation Flow						Inf	Inf

Full Input Data And Results

Scenario 1: '2017 Existing AM Peak' (FG1: '2017 AM Peak Hour Existing', Plan 1: 'Network Control Plan 1')

Stage Sequence Diagram

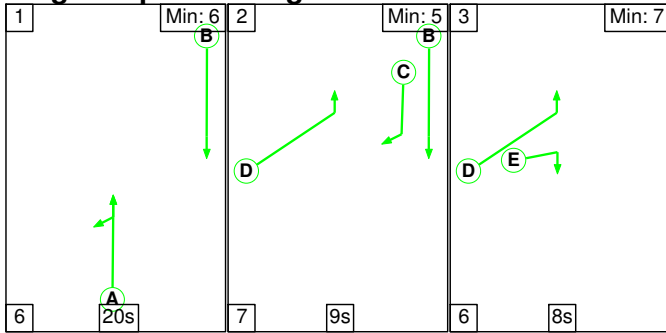

Stage Timings

Stage	1	2	3
Duration	20	9	8
Change Point	0	26	42

Signal Timings Diagram

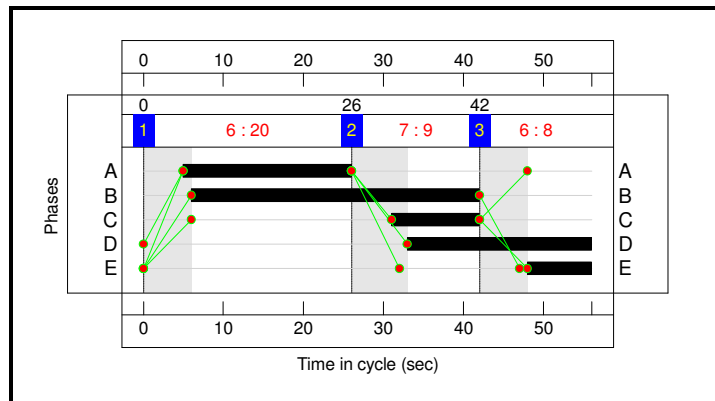

Full Input Data And Results
Network Layout Diagram

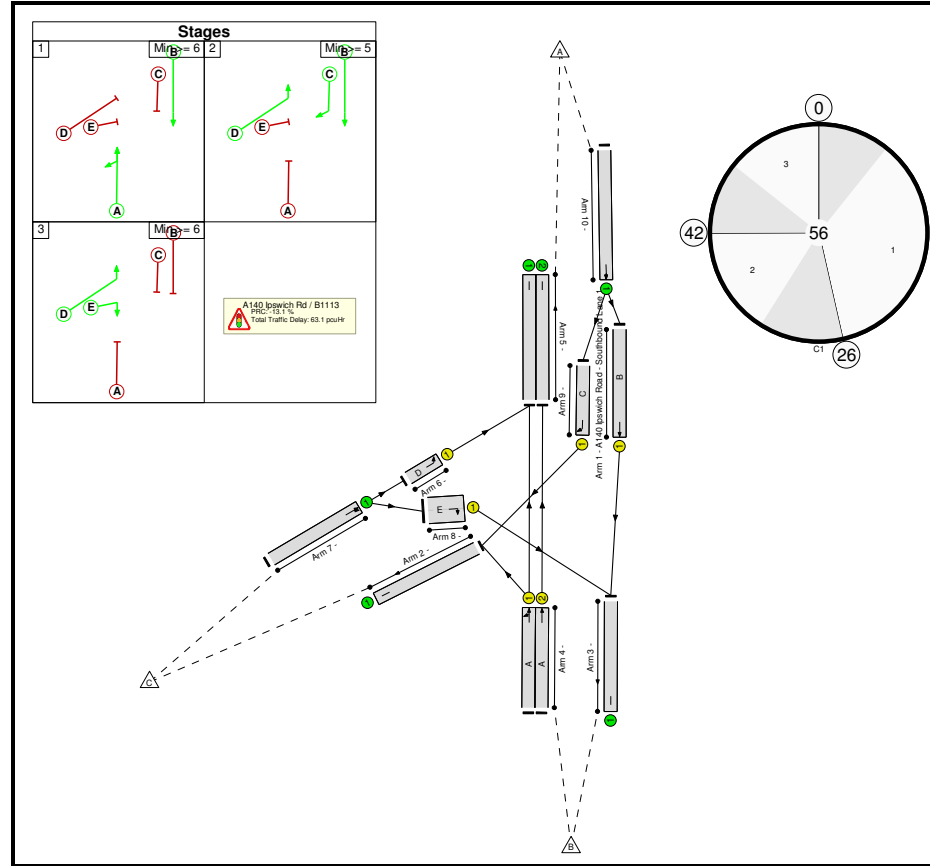

Full Input Data And Results

Network Results

Item	Lane Description	Lane Type	Controller Stream	Position In Filtered Route	Full Phase	Arrow Phase	Num Greens	Total Green (s)	Arrow Green (s)	Demand Flow (pcu)	Sat Flow (pcu/Hr)	Capacity (pcu)	Deg Sat (%)
Network: Existing junction model	-	-	N/A	-	-		-	-	-	-	-	-	101.8%
A140 Ipswich Rd / B1113	-	-	N/A	-	-		-	-	-	-	-	-	101.8%
1/1	A140 Ipswich Road - Southbound Lane 1 Ahead	U	N/A	N/A	B		1	36	-	650	1065	704	92.4%
2/1		U	N/A	N/A	-		-	-	-	295	Inf	Inf	0.0%
3/1		U	N/A	N/A	-		-	-	-	800	Inf	Inf	0.0%
4/1	Left Ahead	U	N/A	N/A	A		1	21	-	664	1660	652	101.8%
4/2	Ahead	U	N/A	N/A	A		1	21	-	640	1610	632	101.2%
5/1		U	N/A	N/A	-		-	-	-	1047	Inf	Inf	0.0%
5/2		U	N/A	N/A	-		-	-	-	640	Inf	Inf	0.0%
6/1	Left	U	N/A	N/A	D		1	23	-	524	1295	555	94.4%
7/1	Ahead Ahead2	U	N/A	N/A	-		-	-	-	674	Inf	Inf	0.0%
8/1	Right	U	N/A	N/A	E		1	8	-	150	950	153	98.2%
9/1	Right	U	N/A	N/A	C		1	11	-	154	795	170	90.4%
10/1	Ahead Ahead2	U	N/A	N/A	-		-	-	-	804	Inf	Inf	0.0%

Full Input Data And Results

Scenario 2: '2017 Existing PM Peak' (FG2: '2017 PM Peak Hour Existing', Plan 1: 'Network Control Plan 1')

Stage Sequence Diagram

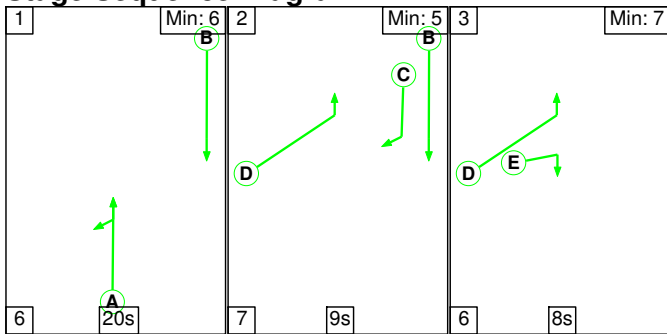

Stage Timings

Stage	1	2	3
Duration	20	9	8
Change Point	0	26	42

Signal Timings Diagram

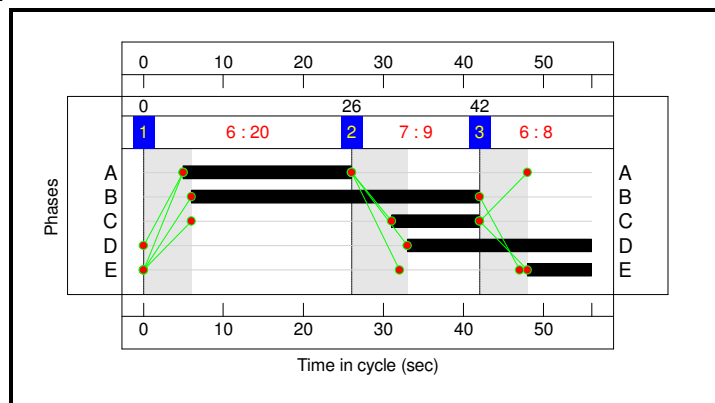

Full Input Data And Results
Network Layout Diagram

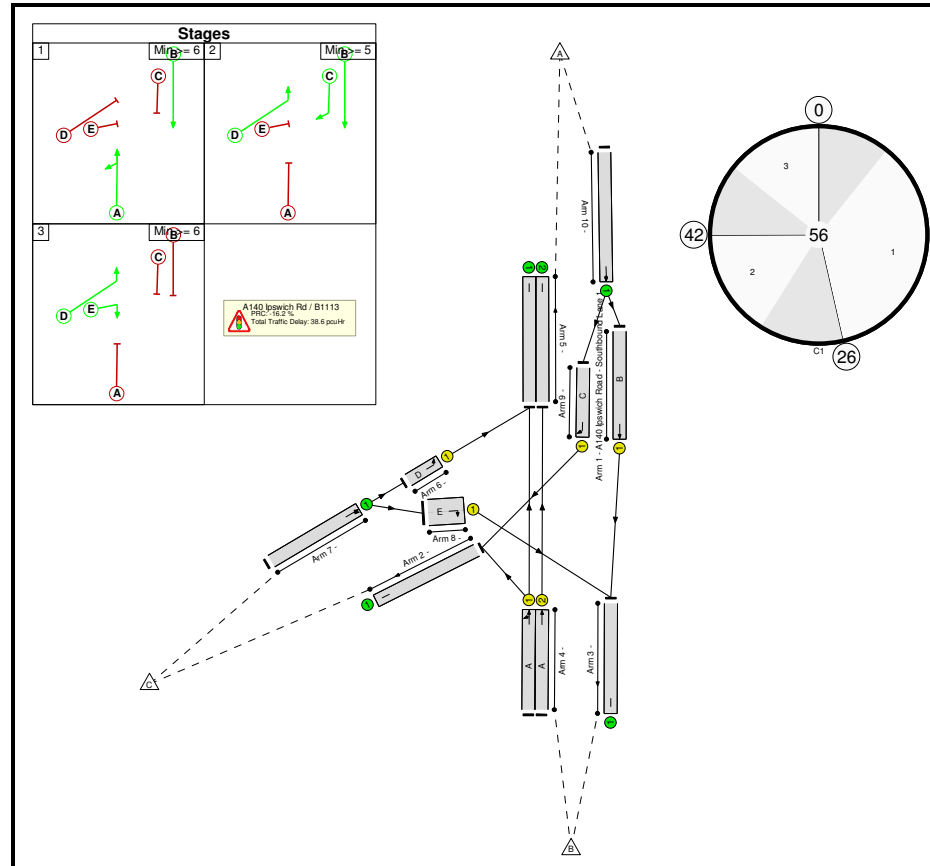

Full Input Data And Results

Network Results

Item	Lane Description	Lane Type	Controller Stream	Position In Filtered Route	Full Phase	Arrow Phase	Num Greens	Total Green (s)	Arrow Green (s)	Demand Flow (pcu)	Sat Flow (pcu/Hr)	Capacity (pcu)	Deg Sat (%)
Network: Existing junction model	-	-	N/A	-	-		-	-	-	-	-	-	104.6%
A140 Ipswich Rd / B1113	-	-	N/A	-	-		-	-	-	-	-	-	104.6%
1/1	A140 Ipswich Road - Southbound Lane 1 Ahead	U	N/A	N/A	B		1	36	-	1023	2010	1328	77.0%
2/1		U	N/A	N/A	-		-	-	-	561	Inf	Inf	0.0%
3/1		U	N/A	N/A	-		-	-	-	1164	Inf	Inf	0.0%
4/1	Left Ahead	U	N/A	N/A	A		1	21	-	189	460	181	104.6%
4/2	Ahead	U	N/A	N/A	A		1	21	-	706	2600	1021	69.1%
5/1		U	N/A	N/A	-		-	-	-	253	Inf	Inf	0.0%
5/2		U	N/A	N/A	-		-	-	-	706	Inf	Inf	0.0%
6/1	Left	U	N/A	N/A	D		1	23	-	253	620	266	95.2%
7/1	Ahead Ahead2	U	N/A	N/A	-		-	-	-	394	Inf	Inf	0.0%
8/1	Right	U	N/A	N/A	E		1	8	-	141	890	143	98.6%
9/1	Right	U	N/A	N/A	C		1	11	-	372	1835	393	94.6%
10/1	Ahead Ahead2	U	N/A	N/A	-		-	-	-	1395	Inf	Inf	0.0%

Full Input Data And Results

Item	Arriving (pcu)	Leaving (pcu)	Turners In Gaps (pcu)	Turners When Unopposed (pcu)	Turners In Intergreen (pcu)	Uniform Delay (pcuHr)	Rand + Oversat Delay (pcuHr)	Storage Area Uniform Delay (pcuHr)	Total Delay (pcuHr)	Av. Delay Per PCU (s/pcu)	Max. Back of Uniform Queue (pcu)	Rand + Oversat Queue (pcu)	Mean Max Queue (pcu)
Network: Existing junction model	-	-	0	0	0	10.0	28.6	0.0	38.6	-	-	-	-
A140 Ipswich Rd / B1113	-	-	0	0	0	10.0	28.6	0.0	38.6	-	-	-	-
1/1	1023	1023	-	-	-	1.9	1.7	-	3.5	12.4	10.8	1.7	12.5
2/1	553	553	-	-	-	0.0	0.0	-	0.0	0.0	0.0	0.0	0.0
3/1	1164	1164	-	-	-	0.0	0.0	-	0.0	0.0	0.0	0.0	0.0
4/1	189	181	-	-	-	1.1	9.3	-	10.4	197.3	3.1	9.3	12.3
4/2	706	706	-	-	-	2.8	1.1	-	3.9	19.8	9.0	1.1	10.1
5/1	253	253	-	-	-	0.0	0.0	-	0.0	0.0	0.0	0.0	0.0
5/2	706	706	-	-	-	0.0	0.0	-	0.0	0.0	0.0	0.0	0.0
6/1	253	253	-	-	-	1.1	5.4	-	6.5	92.1	3.8	5.4	9.2
7/1	394	394	-	-	-	0.0	0.0	-	0.0	0.0	0.0	0.0	0.0
8/1	141	141	-	-	-	0.9	5.5	-	6.4	162.6	1.1	2.7	3.8
9/1	372	372	-	-	-	2.2	5.7	-	7.9	76.9	5.7	5.7	11.4
10/1	1395	1395	-	-	-	0.0	0.0	-	0.0	0.0	0.0	0.0	0.0
C1 PRC for Signalled Lanes (%): -16.2 Total Delay for Signalled Lanes (pcuHr): 38.56 Cycle Time (s): 56 PRC Over All Lanes (%): -16.2 Total Delay Over All Lanes(pcuHr): 38.56													

Full Input Data And Results

Scenario 3: '2022 Growthed AM Peak' (FG3: '2022 AM Peak Hour Growthed', Plan 1: 'Network Control Plan 1')

Stage Sequence Diagram

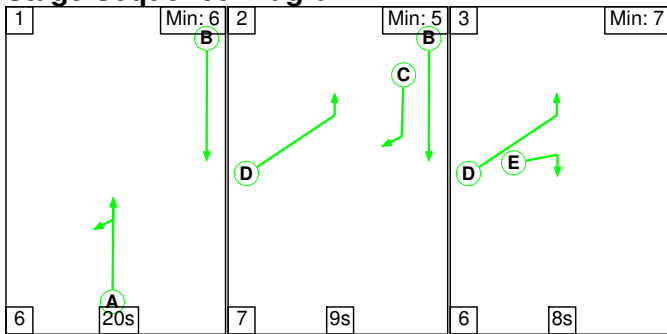

Stage Timings

Stage	1	2	3
Duration	20	9	8
Change Point	0	26	42

Signal Timings Diagram

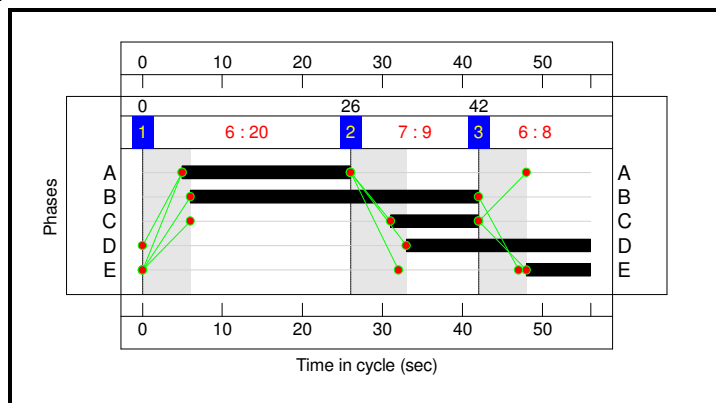

Full Input Data And Results
Network Layout Diagram

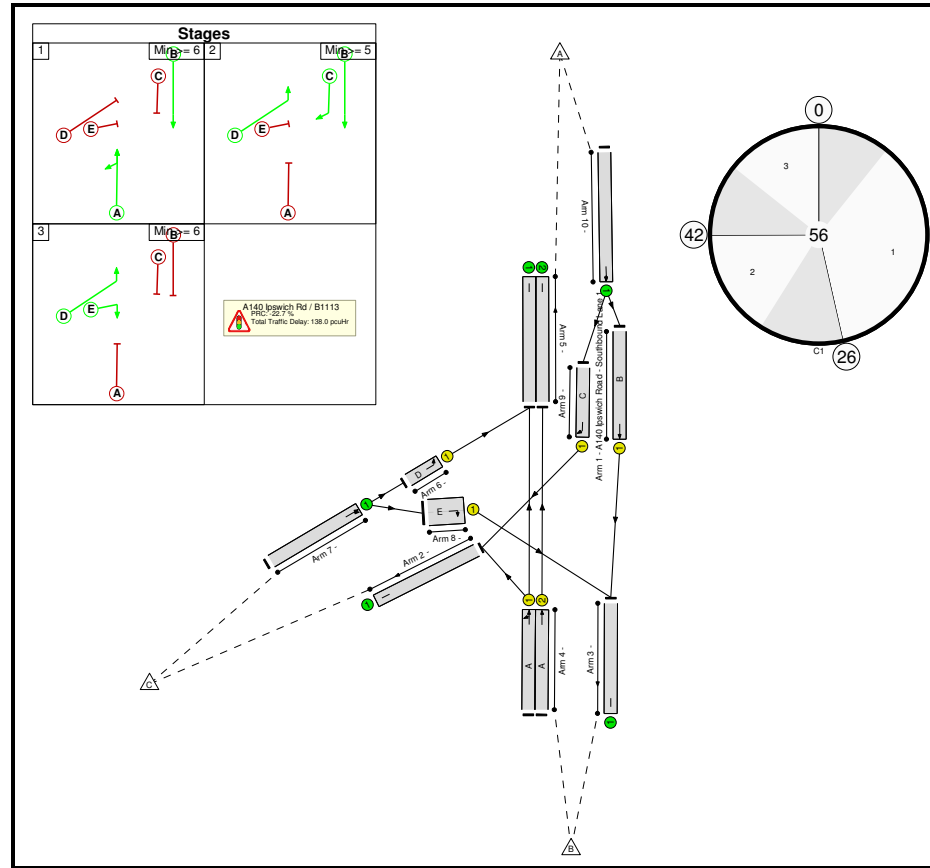

Full Input Data And Results

Network Results

Item	Lane Description	Lane Type	Controller Stream	Position In Filtered Route	Full Phase	Arrow Phase	Num Greens	Total Green (s)	Arrow Green (s)	Demand Flow (pcu)	Sat Flow (pcu/Hr)	Capacity (pcu)	Deg Sat (%)
Network: Existing junction model	-	-	N/A	-	-		-	-	-	-	-	-	110.4%
A140 Ipswich Rd / B1113	-	-	N/A	-	-		-	-	-	-	-	-	110.4%
1/1	A140 Ipswich Road - Southbound Lane 1 Ahead	U	N/A	N/A	B		1	36	-	706	1065	704	100.3%
2/1		U	N/A	N/A	-		-	-	-	320	Inf	Inf	0.0%
3/1		U	N/A	N/A	-		-	-	-	869	Inf	Inf	0.0%
4/1	Left Ahead	U	N/A	N/A	A		1	21	-	720	1660	652	110.4%
4/2	Ahead	U	N/A	N/A	A		1	21	-	697	1610	632	110.2%
5/1		U	N/A	N/A	-		-	-	-	1136	Inf	Inf	0.0%
5/2		U	N/A	N/A	-		-	-	-	697	Inf	Inf	0.0%
6/1	Left	U	N/A	N/A	D		1	23	-	569	1295	555	102.5%
7/1	Ahead Ahead2	U	N/A	N/A	-		-	-	-	732	Inf	Inf	0.0%
8/1	Right	U	N/A	N/A	E		1	8	-	163	950	153	106.8%
9/1	Right	U	N/A	N/A	C		1	11	-	167	795	170	98.0%
10/1	Ahead Ahead2	U	N/A	N/A	-		-	-	-	873	Inf	Inf	0.0%

Full Input Data And Results

Item	Arriving (pcu)	Leaving (pcu)	Turners In Gaps (pcu)	Turners When Unopposed (pcu)	Turners In Intergreen (pcu)	Uniform Delay (pcuHr)	Rand + Oversat Delay (pcuHr)	Storage Area Uniform Delay (pcuHr)	Total Delay (pcuHr)	Av. Delay Per PCU (s/pcu)	Max. Back of Uniform Queue (pcu)	Rand + Oversat Queue (pcu)	Mean Max Queue (pcu)
Network: Existing junction model	-	-	0	0	0	17.5	120.5	0.0	138.0	-	-	-	-
A140 Ipswich Rd / B1113	-	-	0	0	0	17.5	120.5	0.0	138.0	-	-	-	-
1/1	706	704	-	-	-	1.9	13.9	-	15.8	80.6	11.0	13.9	24.9
2/1	306	306	-	-	-	0.0	0.0	-	0.0	0.0	0.0	0.0	0.0
3/1	856	856	-	-	-	0.0	0.0	-	0.0	0.0	0.0	0.0	0.0
4/1	720	652	-	-	-	5.2	38.6	-	43.8	218.9	12.3	38.6	50.8
4/2	697	632	-	-	-	5.0	37.0	-	41.9	216.7	11.8	37.0	48.8
5/1	1069	1069	-	-	-	0.0	0.0	-	0.0	0.0	0.0	0.0	0.0
5/2	633	633	-	-	-	0.0	0.0	-	0.0	0.0	0.0	0.0	0.0
6/1	569	555	-	-	-	3.0	15.9	-	18.9	119.8	9.1	15.9	25.0
7/1	732	732	-	-	-	0.0	0.0	-	0.0	0.0	0.0	0.0	0.0
8/1	163	153	-	-	-	1.4	9.5	-	10.9	239.8	1.4	4.7	6.1
9/1	167	167	-	-	-	1.0	5.7	-	6.7	144.3	2.6	5.7	8.2
10/1	873	873	-	-	-	0.0	0.0	-	0.0	0.0	0.0	0.0	0.0
C1 PRC for Signalled Lanes (%): -22.7 Total Delay for Signalled Lanes (pcuHr): 138.00 Cycle Time (s): 56 PRC Over All Lanes (%): -22.7 Total Delay Over All Lanes(pcuHr): 138.00													

Full Input Data And Results

Scenario 4: '2022 Growthed PM Peak' (FG4: '2022 PM Peak Hour Growthed', Plan 1: 'Network Control Plan 1')

Stage Sequence Diagram

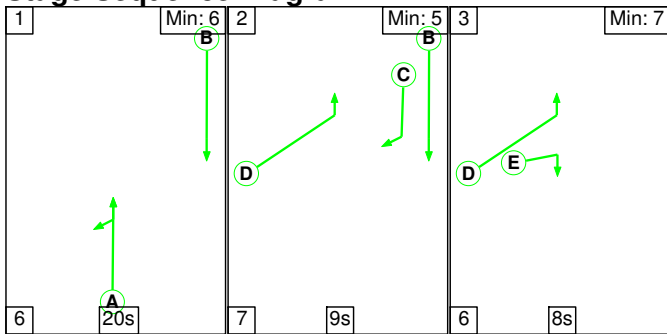

Stage Timings

Stage	1	2	3
Duration	20	9	8
Change Point	0	26	42

Signal Timings Diagram

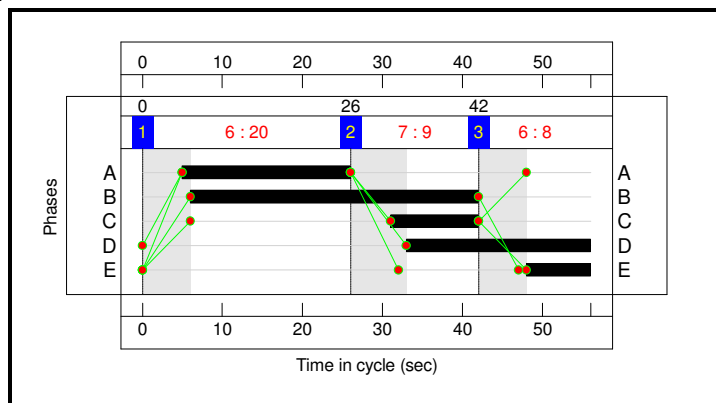

Full Input Data And Results
Network Layout Diagram

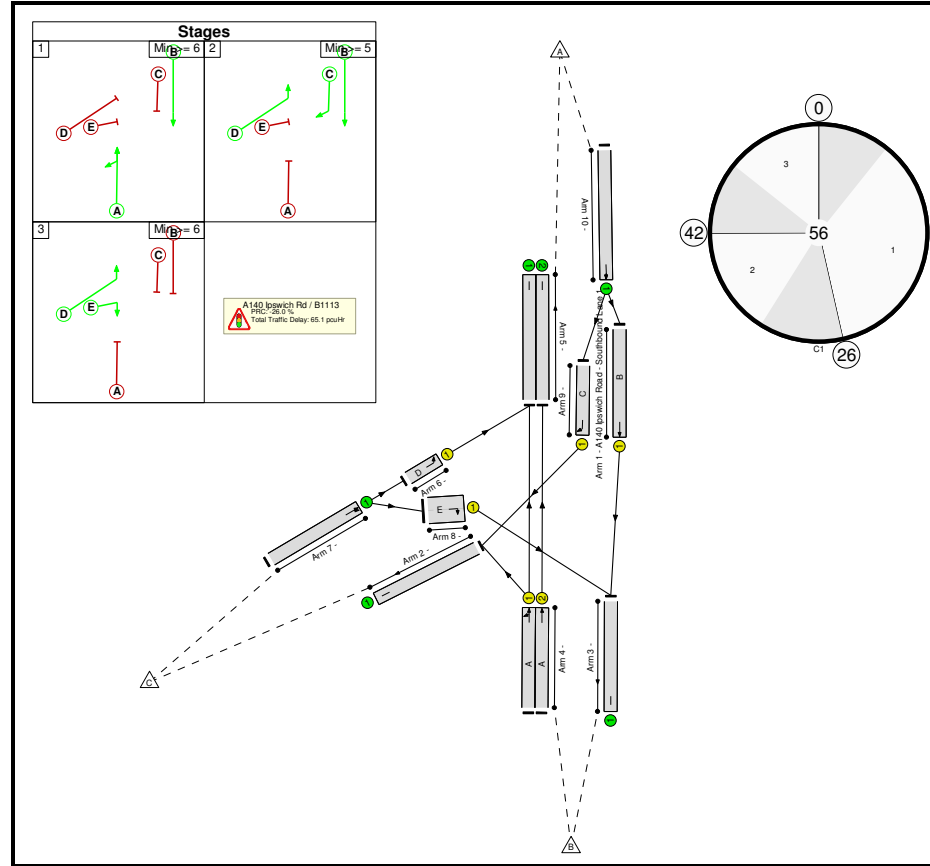

Full Input Data And Results

Network Results

Item	Lane Description	Lane Type	Controller Stream	Position In Filtered Route	Full Phase	Arrow Phase	Num Greens	Total Green (s)	Arrow Green (s)	Demand Flow (pcu)	Sat Flow (pcu/Hr)	Capacity (pcu)	Deg Sat (%)
Network: Existing junction model	-	-	N/A	-	-		-	-	-	-	-	-	113.4%
A140 Ipswich Rd / B1113	-	-	N/A	-	-		-	-	-	-	-	-	113.4%
1/1	A140 Ipswich Road - Southbound Lane 1 Ahead	U	N/A	N/A	B		1	36	-	1112	2010	1328	83.7%
2/1		U	N/A	N/A	-		-	-	-	609	Inf	Inf	0.0%
3/1		U	N/A	N/A	-		-	-	-	1265	Inf	Inf	0.0%
4/1	Left Ahead	U	N/A	N/A	A		1	21	-	205	460	181	113.4%
4/2	Ahead	U	N/A	N/A	A		1	21	-	767	2600	1021	75.1%
5/1		U	N/A	N/A	-		-	-	-	275	Inf	Inf	0.0%
5/2		U	N/A	N/A	-		-	-	-	767	Inf	Inf	0.0%
6/1	Left	U	N/A	N/A	D		1	23	-	275	620	266	103.5%
7/1	Ahead Ahead2	U	N/A	N/A	-		-	-	-	428	Inf	Inf	0.0%
8/1	Right	U	N/A	N/A	E		1	8	-	153	890	143	107.0%
9/1	Right	U	N/A	N/A	C		1	11	-	404	1835	393	102.7%
10/1	Ahead Ahead2	U	N/A	N/A	-		-	-	-	1516	Inf	Inf	0.0%

Full Input Data And Results

Item	Arriving (pcu)	Leaving (pcu)	Turners In Gaps (pcu)	Turners When Unopposed (pcu)	Turners In Intergreen (pcu)	Uniform Delay (pcuHr)	Rand + Oversat Delay (pcuHr)	Storage Area Uniform Delay (pcuHr)	Total Delay (pcuHr)	Av. Delay Per PCU (s/pcu)	Max. Back of Uniform Queue (pcu)	Rand + Oversat Queue (pcu)	Mean Max Queue (pcu)
Network: Existing junction model	-	-	0	0	0	12.5	52.7	0.0	65.1	-	-	-	-
A140 Ipswich Rd / B1113	-	-	0	0	0	12.5	52.7	0.0	65.1	-	-	-	-
1/1	1112	1112	-	-	-	2.2	2.5	-	4.7	15.4	13.0	2.5	15.5
2/1	574	574	-	-	-	0.0	0.0	-	0.0	0.0	0.0	0.0	0.0
3/1	1255	1255	-	-	-	0.0	0.0	-	0.0	0.0	0.0	0.0	0.0
4/1	205	181	-	-	-	1.6	15.5	-	17.1	299.7	3.6	15.5	19.0
4/2	767	767	-	-	-	3.1	1.5	-	4.6	21.6	10.2	1.5	11.7
5/1	266	266	-	-	-	0.0	0.0	-	0.0	0.0	0.0	0.0	0.0
5/2	767	767	-	-	-	0.0	0.0	-	0.0	0.0	0.0	0.0	0.0
6/1	275	266	-	-	-	1.5	10.9	-	12.5	163.2	4.4	10.9	15.4
7/1	428	428	-	-	-	0.0	0.0	-	0.0	0.0	0.0	0.0	0.0
8/1	153	143	-	-	-	1.3	9.2	-	10.5	246.4	1.3	4.6	5.9
9/1	404	393	-	-	-	2.7	13.1	-	15.8	140.7	6.5	13.1	19.6
10/1	1516	1516	-	-	-	0.0	0.0	-	0.0	0.0	0.0	0.0	0.0
C1 PRC for Signalled Lanes (%): -26.0 Total Delay for Signalled Lanes (pcuHr): 65.15 Cycle Time (s): 56 PRC Over All Lanes (%): -26.0 Total Delay Over All Lanes(pcuHr): 65.15													

Full Input Data And Results

Scenario 5: '2022 AM Peak + Proposed Development' (FG5: '2022 AM Peak Hour + Proposed Development', Plan 1: 'Network Control Plan 1')

Stage Sequence Diagram

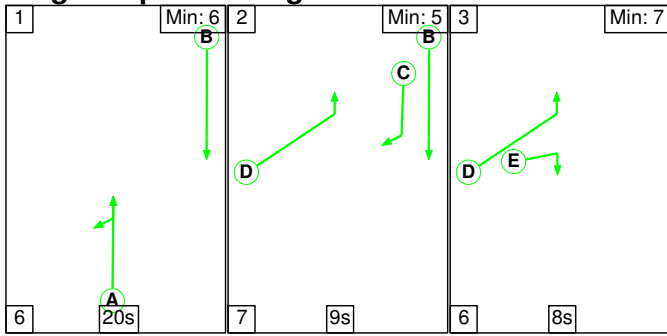

Stage Timings

Stage	1	2	3
Duration	20	9	8
Change Point	0	26	42

Signal Timings Diagram

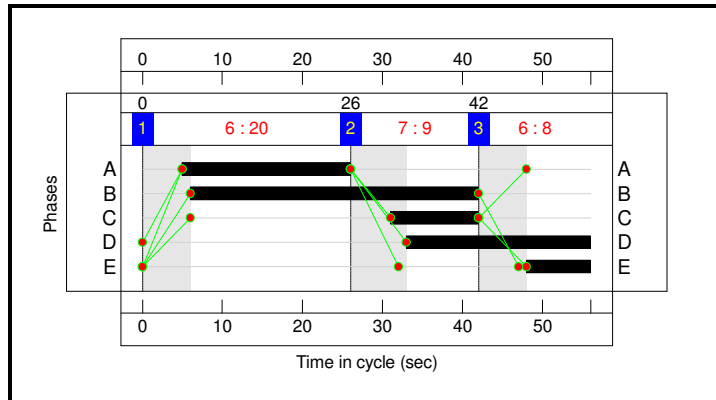

Full Input Data And Results
Network Layout Diagram

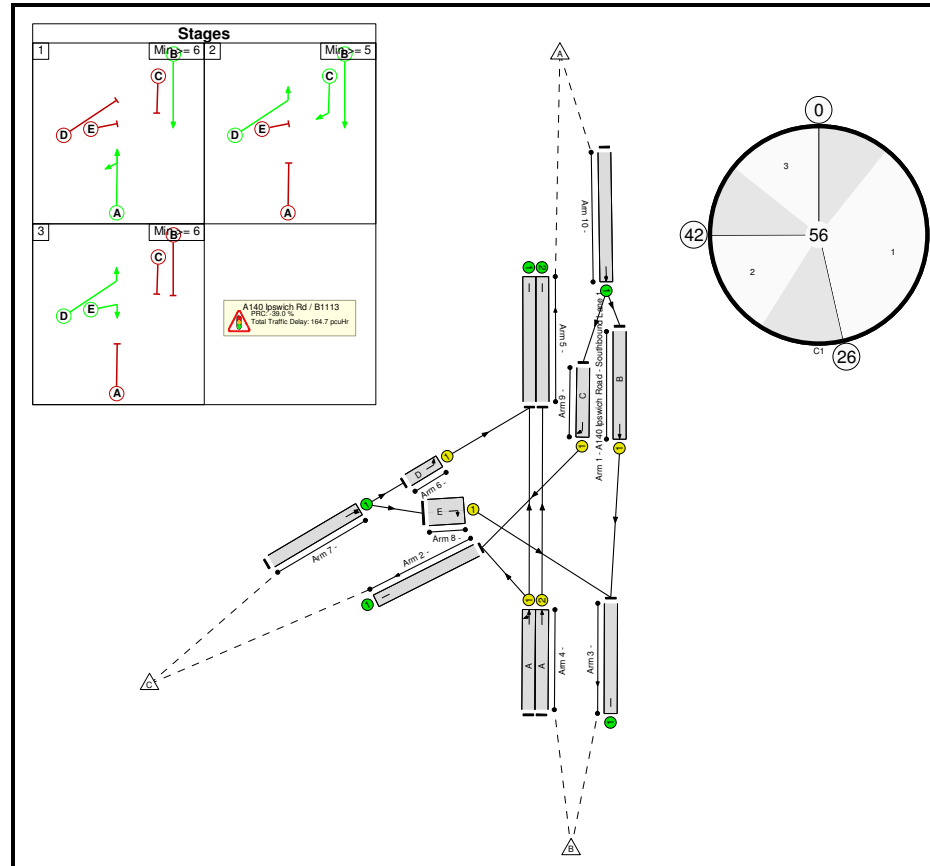

Full Input Data And Results

Network Results

Item	Lane Description	Lane Type	Controller Stream	Position In Filtered Route	Full Phase	Arrow Phase	Num Greens	Total Green (s)	Arrow Green (s)	Demand Flow (pcu)	Sat Flow (pcu/Hr)	Capacity (pcu)	Deg Sat (%)
Network: Existing junction model	-	-	N/A	-	-		-	-	-	-	-	-	125.1%
A140 Ipswich Rd / B1113	-	-	N/A	-	-		-	-	-	-	-	-	125.1%
1/1	A140 Ipswich Road - Southbound Lane 1 Ahead	U	N/A	N/A	B		1	36	-	706	1065	704	100.3%
2/1		U	N/A	N/A	-		-	-	-	348	Inf	Inf	0.0%
3/1		U	N/A	N/A	-		-	-	-	897	Inf	Inf	0.0%
4/1	Left Ahead	U	N/A	N/A	A		1	21	-	734	1660	652	112.6%
4/2	Ahead	U	N/A	N/A	A		1	21	-	711	1610	632	112.4%
5/1		U	N/A	N/A	-		-	-	-	1122	Inf	Inf	0.0%
5/2		U	N/A	N/A	-		-	-	-	711	Inf	Inf	0.0%
6/1	Left	U	N/A	N/A	D		1	23	-	569	1295	555	102.5%
7/1	Ahead Ahead2	U	N/A	N/A	-		-	-	-	760	Inf	Inf	0.0%
8/1	Right	U	N/A	N/A	E		1	8	-	191	950	153	125.1%
9/1	Right	U	N/A	N/A	C		1	11	-	167	795	170	98.0%
10/1	Ahead Ahead2	U	N/A	N/A	-		-	-	-	873	Inf	Inf	0.0%

Full Input Data And Results

Item	Arriving (pcu)	Leaving (pcu)	Turners In Gaps (pcu)	Turners When Unopposed (pcu)	Turners In Intergreen (pcu)	Uniform Delay (pcuHr)	Rand + Oversat Delay (pcuHr)	Storage Area Uniform Delay (pcuHr)	Total Delay (pcuHr)	Av. Delay Per PCU (s/pcu)	Max. Back of Uniform Queue (pcu)	Rand + Oversat Queue (pcu)	Mean Max Queue (pcu)
Network: Existing junction model	-	-	0	0	0	19.4	145.2	0.0	164.7	-	-	-	-
A140 Ipswich Rd / B1113	-	-	0	0	0	19.4	145.2	0.0	164.7	-	-	-	-
1/1	706	704	-	-	-	1.9	13.9	-	15.8	80.6	11.0	13.9	24.9
2/1	328	328	-	-	-	0.0	0.0	-	0.0	0.0	0.0	0.0	0.0
3/1	856	856	-	-	-	0.0	0.0	-	0.0	0.0	0.0	0.0	0.0
4/1	734	652	-	-	-	5.6	45.0	-	50.6	248.3	12.7	45.0	57.7
4/2	711	632	-	-	-	5.4	43.4	-	48.8	246.9	12.3	43.4	55.6
5/1	1046	1046	-	-	-	0.0	0.0	-	0.0	0.0	0.0	0.0	0.0
5/2	633	633	-	-	-	0.0	0.0	-	0.0	0.0	0.0	0.0	0.0
6/1	569	555	-	-	-	3.0	15.9	-	18.9	119.8	9.1	15.9	25.0
7/1	760	760	-	-	-	0.0	0.0	-	0.0	0.0	0.0	0.0	0.0
8/1	191	153	-	-	-	2.5	21.4	-	23.9	449.6	2.0	10.7	12.7
9/1	167	167	-	-	-	1.0	5.7	-	6.7	144.3	2.6	5.7	8.2
10/1	873	873	-	-	-	0.0	0.0	-	0.0	0.0	0.0	0.0	0.0
C1			PRC for Signalled Lanes (%): -39.0			Total Delay for Signalled Lanes (pcuHr): 164.67		Cycle Time (s): 56					
			PRC Over All Lanes (%): -39.0			Total Delay Over All Lanes(pcuHr): 164.67							

Full Input Data And Results

Scenario 6: '2022 PM Peak + Proposed Development' (FG6: '2022 PM Peak Hour + Proposed Development', Plan 1: 'Network Control Plan 1')

Stage Sequence Diagram

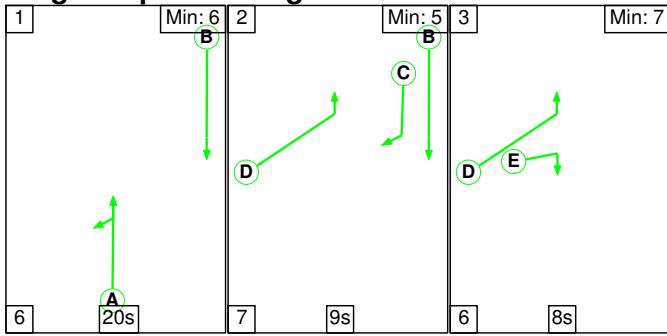

Stage Timings

Stage	1	2	3
Duration	20	9	8
Change Point	0	26	42

Signal Timings Diagram

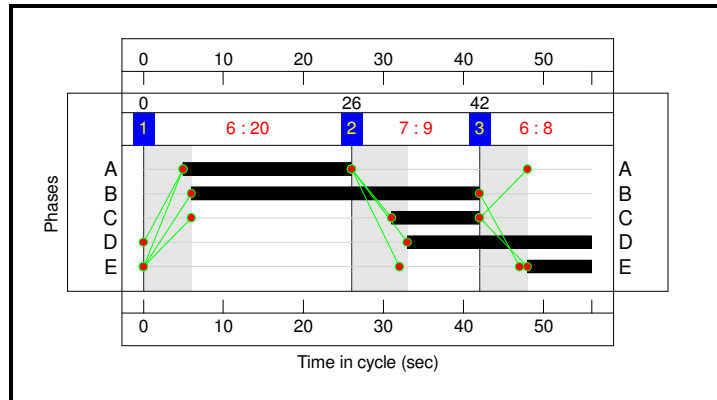

Full Input Data And Results
Network Layout Diagram

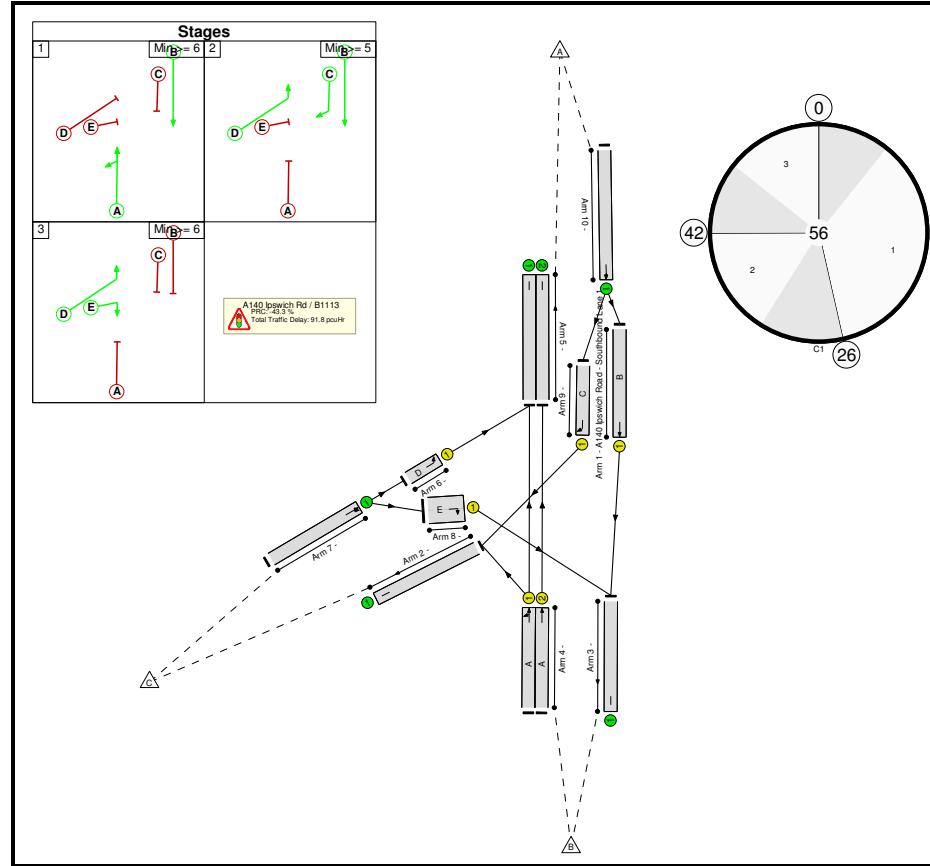

Full Input Data And Results

Network Results

Item	Lane Description	Lane Type	Controller Stream	Position In Filtered Route	Full Phase	Arrow Phase	Num Greens	Total Green (s)	Arrow Green (s)	Demand Flow (pcu)	Sat Flow (pcu/Hr)	Capacity (pcu)	Deg Sat (%)
Network: Existing junction model	-	-	N/A	-	-		-	-	-	-	-	-	128.9%
A140 Ipswich Rd / B1113	-	-	N/A	-	-		-	-	-	-	-	-	128.9%
1/1	A140 Ipswich Road - Southbound Lane 1 Ahead	U	N/A	N/A	B		1	36	-	1112	2010	1328	83.7%
2/1		U	N/A	N/A	-		-	-	-	637	Inf	Inf	0.0%
3/1		U	N/A	N/A	-		-	-	-	1293	Inf	Inf	0.0%
4/1	Left Ahead	U	N/A	N/A	A		1	21	-	233	460	181	128.9%
4/2	Ahead	U	N/A	N/A	A		1	21	-	767	2600	1021	75.1%
5/1		U	N/A	N/A	-		-	-	-	275	Inf	Inf	0.0%
5/2		U	N/A	N/A	-		-	-	-	767	Inf	Inf	0.0%
6/1	Left	U	N/A	N/A	D		1	23	-	275	620	266	103.5%
7/1	Ahead Ahead2	U	N/A	N/A	-		-	-	-	456	Inf	Inf	0.0%
8/1	Right	U	N/A	N/A	E		1	8	-	181	890	143	126.5%
9/1	Right	U	N/A	N/A	C		1	11	-	404	1835	393	102.7%
10/1	Ahead Ahead2	U	N/A	N/A	-		-	-	-	1516	Inf	Inf	0.0%

Full Input Data And Results

Item	Arriving (pcu)	Leaving (pcu)	Turners In Gaps (pcu)	Turners When Unopposed (pcu)	Turners In Intergreen (pcu)	Uniform Delay (pcuHr)	Rand + Oversat Delay (pcuHr)	Storage Area Uniform Delay (pcuHr)	Total Delay (pcuHr)	Av. Delay Per PCU (s/pcu)	Max. Back of Uniform Queue (pcu)	Rand + Oversat Queue (pcu)	Mean Max Queue (pcu)
Network: Existing junction model	-	-	0	0	0	14.4	77.4	0.0	91.8	-	-	-	-
A140 Ipswich Rd / B1113	-	-	0	0	0	14.4	77.4	0.0	91.8	-	-	-	-
1/1	1112	1112	-	-	-	2.2	2.5	-	4.7	15.4	13.0	2.5	15.5
2/1	574	574	-	-	-	0.0	0.0	-	0.0	0.0	0.0	0.0	0.0
3/1	1255	1255	-	-	-	0.0	0.0	-	0.0	0.0	0.0	0.0	0.0
4/1	233	181	-	-	-	2.5	28.2	-	30.7	474.0	4.4	28.2	32.6
4/2	767	767	-	-	-	3.1	1.5	-	4.6	21.6	10.2	1.5	11.7
5/1	266	266	-	-	-	0.0	0.0	-	0.0	0.0	0.0	0.0	0.0
5/2	767	767	-	-	-	0.0	0.0	-	0.0	0.0	0.0	0.0	0.0
6/1	275	266	-	-	-	1.5	10.9	-	12.5	163.2	4.4	10.9	15.4
7/1	456	456	-	-	-	0.0	0.0	-	0.0	0.0	0.0	0.0	0.0
8/1	181	143	-	-	-	2.4	21.1	-	23.5	467.6	1.9	10.6	12.5
9/1	404	393	-	-	-	2.7	13.1	-	15.8	140.7	6.5	13.1	19.6
10/1	1516	1516	-	-	-	0.0	0.0	-	0.0	0.0	0.0	0.0	0.0
C1 PRC for Signalled Lanes (%): -43.3 Total Delay for Signalled Lanes (pcuHr): 91.80 Cycle Time (s): 56 PRC Over All Lanes (%): -43.3 Total Delay Over All Lanes(pcuHr): 91.80													

Full Input Data And Results

Scenario 7: '2022 AM Peak + Proposed Development - Sensitivity Test' (FG7: '2022 AM Peak Hour + Proposed Development - Sensitivity Test', Plan 1: 'Network Control Plan 1')

Stage Sequence Diagram

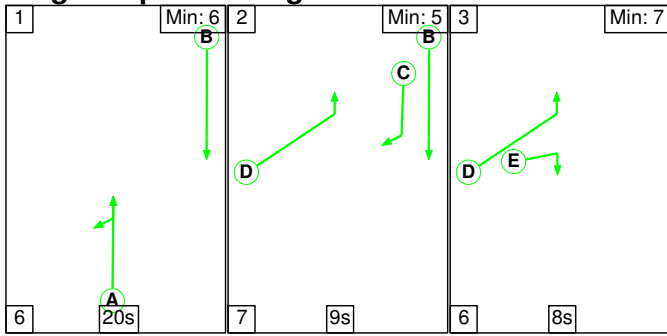

Stage Timings

Stage	1	2	3
Duration	20	9	8
Change Point	0	26	42

Signal Timings Diagram

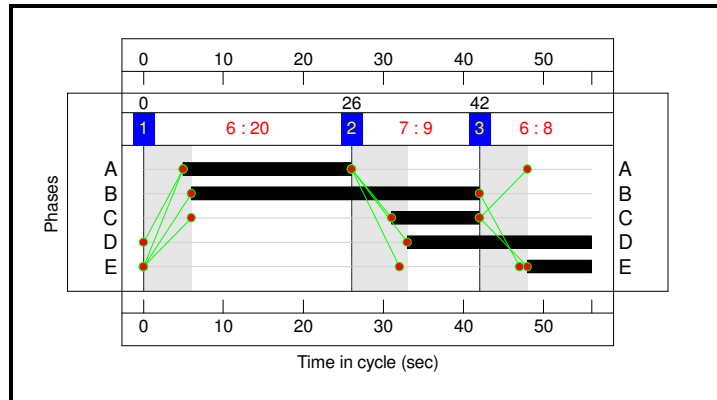

Full Input Data And Results
Network Layout Diagram

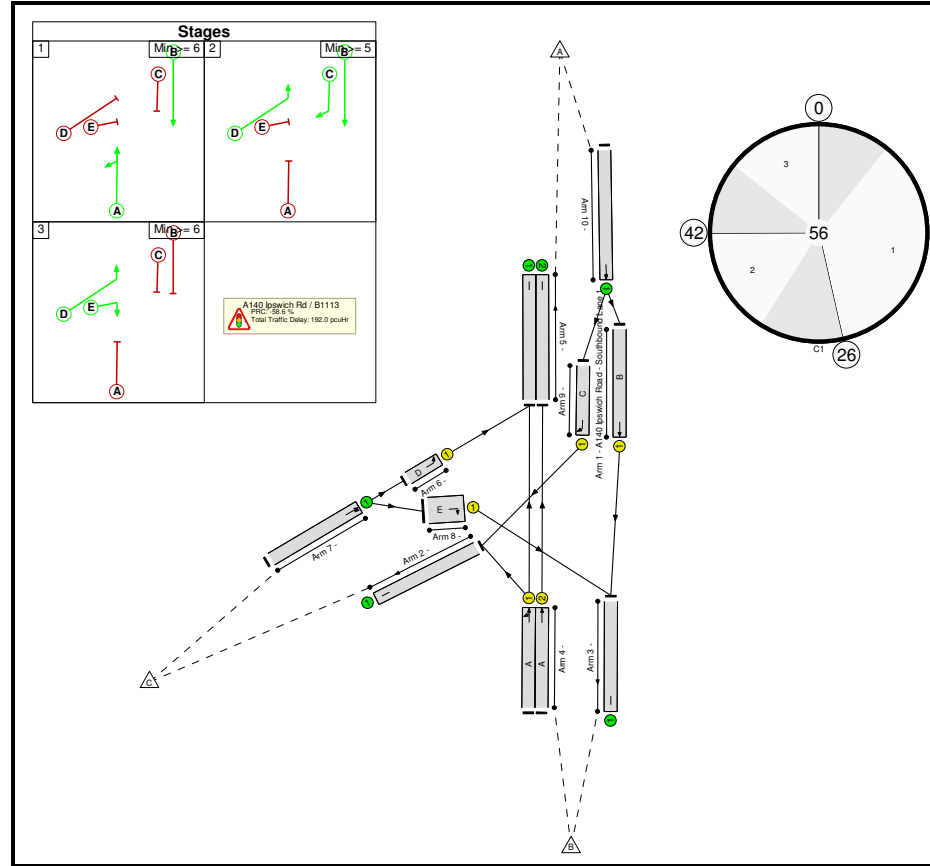

Full Input Data And Results

Network Results

Item	Lane Description	Lane Type	Controller Stream	Position In Filtered Route	Full Phase	Arrow Phase	Num Greens	Total Green (s)	Arrow Green (s)	Demand Flow (pcu)	Sat Flow (pcu/Hr)	Capacity (pcu)	Deg Sat (%)
Network: Existing junction model	-	-	N/A	-	-		-	-	-	-	-	-	142.8%
A140 Ipswich Rd / B1113	-	-	N/A	-	-		-	-	-	-	-	-	142.8%
1/1	A140 Ipswich Road - Southbound Lane 1 Ahead	U	N/A	N/A	B		1	36	-	706	1065	704	100.3%
2/1		U	N/A	N/A	-		-	-	-	375	Inf	Inf	0.0%
3/1		U	N/A	N/A	-		-	-	-	924	Inf	Inf	0.0%
4/1	Left Ahead	U	N/A	N/A	A		1	21	-	747	1660	652	114.5%
4/2	Ahead	U	N/A	N/A	A		1	21	-	725	1610	632	114.6%
5/1		U	N/A	N/A	-		-	-	-	1108	Inf	Inf	0.0%
5/2		U	N/A	N/A	-		-	-	-	725	Inf	Inf	0.0%
6/1	Left	U	N/A	N/A	D		1	23	-	569	1295	555	102.5%
7/1	Ahead Ahead2	U	N/A	N/A	-		-	-	-	787	Inf	Inf	0.0%
8/1	Right	U	N/A	N/A	E		1	8	-	218	950	153	142.8%
9/1	Right	U	N/A	N/A	C		1	11	-	167	795	170	98.0%
10/1	Ahead Ahead2	U	N/A	N/A	-		-	-	-	873	Inf	Inf	0.0%

Full Input Data And Results

Item	Arriving (pcu)	Leaving (pcu)	Turners In Gaps (pcu)	Turners When Unopposed (pcu)	Turners In Intergreen (pcu)	Uniform Delay (pcuHr)	Rand + Oversat Delay (pcuHr)	Storage Area Uniform Delay (pcuHr)	Total Delay (pcuHr)	Av. Delay Per PCU (s/pcu)	Max. Back of Uniform Queue (pcu)	Rand + Oversat Queue (pcu)	Mean Max Queue (pcu)
Network: Existing junction model	-	-	0	0	0	21.3	170.7	0.0	192.0	-	-	-	-
A140 Ipswich Rd / B1113	-	-	0	0	0	21.3	170.7	0.0	192.0	-	-	-	-
1/1	706	704	-	-	-	1.9	13.9	-	15.8	80.6	11.0	13.9	24.9
2/1	349	349	-	-	-	0.0	0.0	-	0.0	0.0	0.0	0.0	0.0
3/1	856	856	-	-	-	0.0	0.0	-	0.0	0.0	0.0	0.0	0.0
4/1	747	652	-	-	-	6.0	51.1	-	57.1	275.2	13.1	51.1	64.2
4/2	725	632	-	-	-	5.9	49.9	-	55.7	276.8	12.7	49.9	62.6
5/1	1026	1026	-	-	-	0.0	0.0	-	0.0	0.0	0.0	0.0	0.0
5/2	633	633	-	-	-	0.0	0.0	-	0.0	0.0	0.0	0.0	0.0
6/1	569	555	-	-	-	3.0	15.9	-	18.9	119.8	9.1	15.9	25.0
7/1	787	787	-	-	-	0.0	0.0	-	0.0	0.0	0.0	0.0	0.0
8/1	218	153	-	-	-	3.5	34.3	-	37.7	623.3	2.6	17.1	19.7
9/1	167	167	-	-	-	1.0	5.7	-	6.7	144.3	2.6	5.7	8.2
10/1	873	873	-	-	-	0.0	0.0	-	0.0	0.0	0.0	0.0	0.0
C1 PRC for Signalled Lanes (%): -58.6 Total Delay for Signalled Lanes (pcuHr): 192.01 Cycle Time (s): 56 PRC Over All Lanes (%): -58.6 Total Delay Over All Lanes(pcuHr): 192.01													

Full Input Data And Results

Scenario 8: '2022 PM Peak + Proposed Development - Sensitivity Test' (FG8: '2022 PM Peak Hour + Proposed Development - Sensitivity Test', Plan 1: 'Network Control Plan 1')

Stage Sequence Diagram

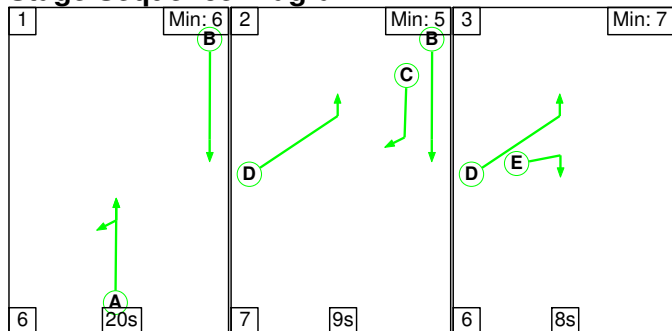

Stage Timings

Stage	1	2	3
Duration	20	9	8
Change Point	0	26	42

Signal Timings Diagram

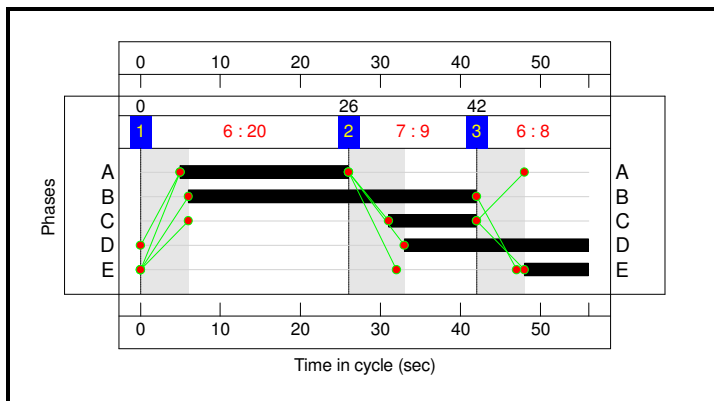

Full Input Data And Results
Network Layout Diagram

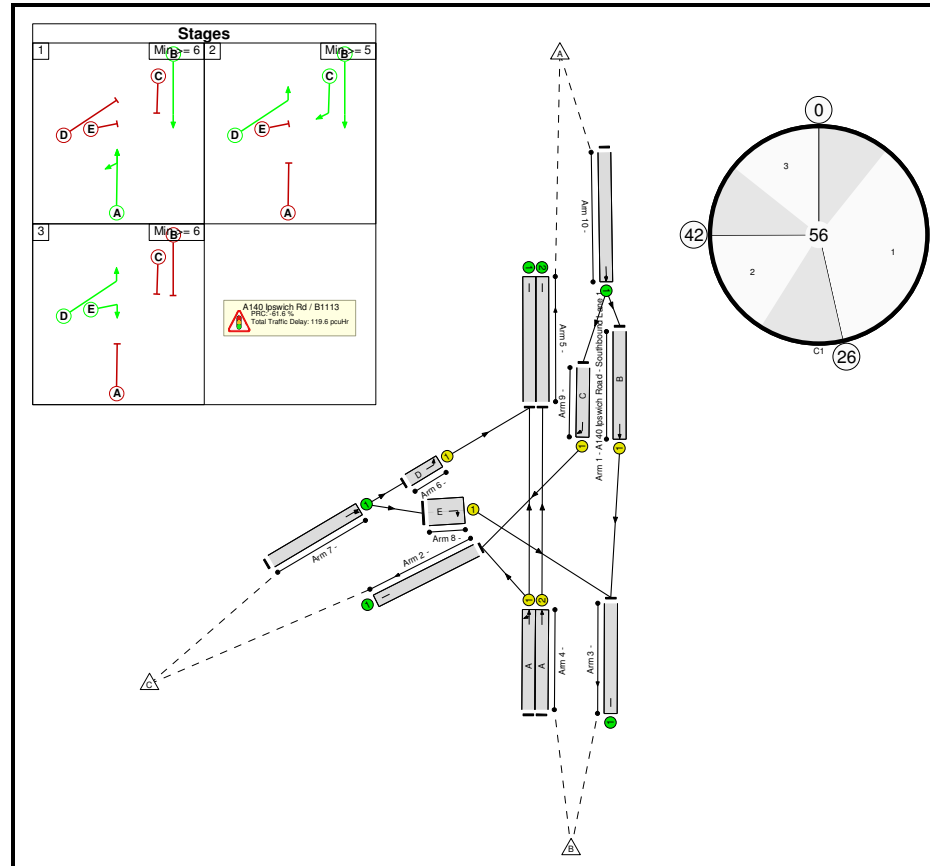

Full Input Data And Results

Network Results

Item	Lane Description	Lane Type	Controller Stream	Position In Filtered Route	Full Phase	Arrow Phase	Num Greens	Total Green (s)	Arrow Green (s)	Demand Flow (pcu)	Sat Flow (pcu/Hr)	Capacity (pcu)	Deg Sat (%)
Network: Existing junction model	-	-	N/A	-	-		-	-	-	-	-	-	145.4%
A140 Ipswich Rd / B1113	-	-	N/A	-	-		-	-	-	-	-	-	145.4%
1/1	A140 Ipswich Road - Southbound Lane 1 Ahead	U	N/A	N/A	B		1	36	-	1112	2010	1328	83.7%
2/1		U	N/A	N/A	-		-	-	-	664	Inf	Inf	0.0%
3/1		U	N/A	N/A	-		-	-	-	1320	Inf	Inf	0.0%
4/1	Left Ahead	U	N/A	N/A	A		1	21	-	260	460	181	143.9%
4/2	Ahead	U	N/A	N/A	A		1	21	-	767	2600	1021	75.1%
5/1		U	N/A	N/A	-		-	-	-	275	Inf	Inf	0.0%
5/2		U	N/A	N/A	-		-	-	-	767	Inf	Inf	0.0%
6/1	Left	U	N/A	N/A	D		1	23	-	275	620	266	103.5%
7/1	Ahead Ahead2	U	N/A	N/A	-		-	-	-	483	Inf	Inf	0.0%
8/1	Right	U	N/A	N/A	E		1	8	-	208	890	143	145.4%
9/1	Right	U	N/A	N/A	C		1	11	-	404	1835	393	102.7%
10/1	Ahead Ahead2	U	N/A	N/A	-		-	-	-	1516	Inf	Inf	0.0%

Full Input Data And Results

Item	Arriving (pcu)	Leaving (pcu)	Turners In Gaps (pcu)	Turners When Unopposed (pcu)	Turners In Intergreen (pcu)	Uniform Delay (pcuHr)	Rand + Oversat Delay (pcuHr)	Storage Area Uniform Delay (pcuHr)	Total Delay (pcuHr)	Av. Delay Per PCU (s/pcu)	Max. Back of Uniform Queue (pcu)	Rand + Oversat Queue (pcu)	Mean Max Queue (pcu)
Network: Existing junction model	-	-	0	0	0	16.3	103.3	0.0	119.6	-	-	-	-
A140 Ipswich Rd / B1113	-	-	0	0	0	16.3	103.3	0.0	119.6	-	-	-	-
1/1	1112	1112	-	-	-	2.2	2.5	-	4.7	15.4	13.0	2.5	15.5
2/1	574	574	-	-	-	0.0	0.0	-	0.0	0.0	0.0	0.0	0.0
3/1	1255	1255	-	-	-	0.0	0.0	-	0.0	0.0	0.0	0.0	0.0
4/1	260	181	-	-	-	3.3	41.2	-	44.5	616.6	5.3	41.2	46.5
4/2	767	767	-	-	-	3.1	1.5	-	4.6	21.6	10.2	1.5	11.7
5/1	266	266	-	-	-	0.0	0.0	-	0.0	0.0	0.0	0.0	0.0
5/2	767	767	-	-	-	0.0	0.0	-	0.0	0.0	0.0	0.0	0.0
6/1	275	266	-	-	-	1.5	10.9	-	12.5	163.2	4.4	10.9	15.4
7/1	483	483	-	-	-	0.0	0.0	-	0.0	0.0	0.0	0.0	0.0
8/1	208	143	-	-	-	3.4	34.0	-	37.4	647.8	2.5	17.0	19.5
9/1	404	393	-	-	-	2.7	13.1	-	15.8	140.7	6.5	13.1	19.6
10/1	1516	1516	-	-	-	0.0	0.0	-	0.0	0.0	0.0	0.0	0.0
C1			PRC for Signalled Lanes (%):		-61.6	Total Delay for Signalled Lanes (pcuHr):		119.57	Cycle Time (s):		56		
			PRC Over All Lanes (%):		-61.6	Total Delay Over All Lanes(pcuHr):		119.57					

Full Input Data And Results

Scenario 9: 'Copy of 2022 AM Peak + Proposed Development' (FG5: '2022 AM Peak Hour + Proposed Development', Plan 1: 'Network Control Plan 1')

Stage Sequence Diagram

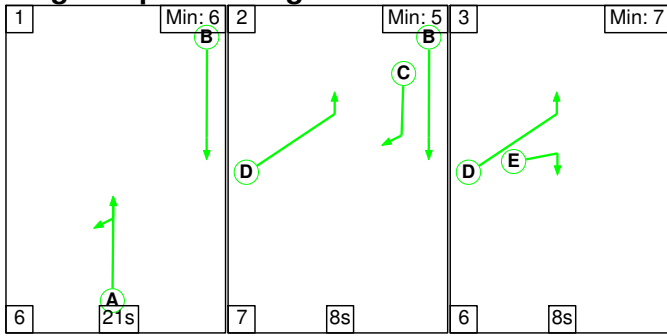

Stage Timings

Stage	1	2	3
Duration	21	8	8
Change Point	0	27	42

Signal Timings Diagram

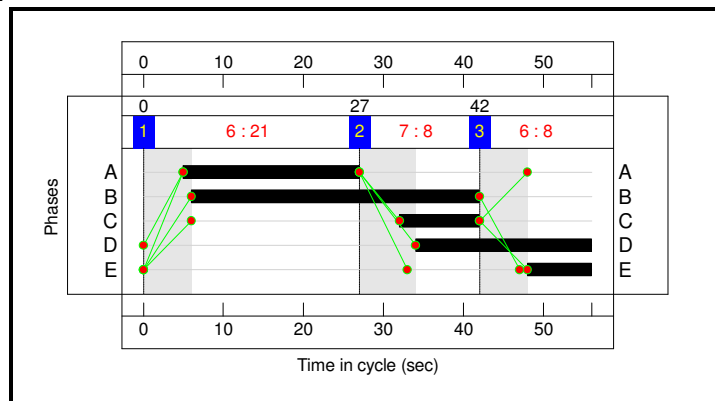

Full Input Data And Results
Network Layout Diagram

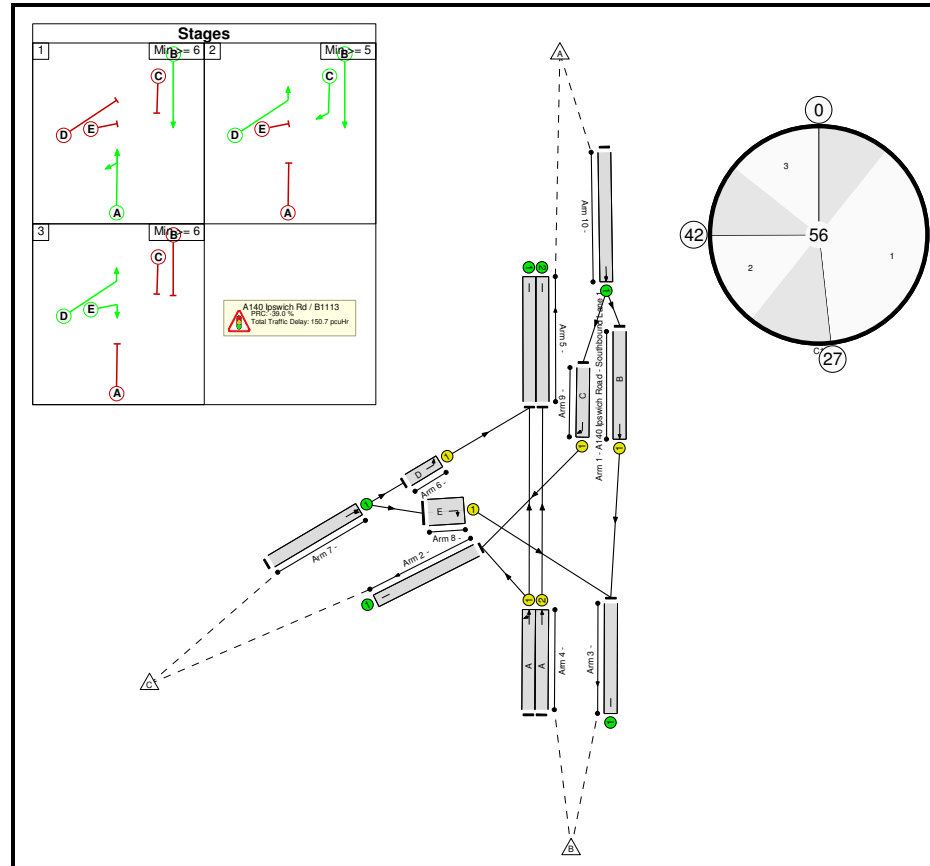

Full Input Data And Results

Network Results

Item	Lane Description	Lane Type	Controller Stream	Position In Filtered Route	Full Phase	Arrow Phase	Num Greens	Total Green (s)	Arrow Green (s)	Demand Flow (pcu)	Sat Flow (pcu/Hr)	Capacity (pcu)	Deg Sat (%)
Network: Existing junction model	-	-	N/A	-	-		-	-	-	-	-	-	125.1%
A140 Ipswich Rd / B1113	-	-	N/A	-	-		-	-	-	-	-	-	125.1%
1/1	A140 Ipswich Road - Southbound Lane 1 Ahead	U	N/A	N/A	B		1	36	-	706	1065	704	100.3%
2/1		U	N/A	N/A	-		-	-	-	348	Inf	Inf	0.0%
3/1		U	N/A	N/A	-		-	-	-	897	Inf	Inf	0.0%
4/1	Left Ahead	U	N/A	N/A	A		1	22	-	734	1660	682	107.7%
4/2	Ahead	U	N/A	N/A	A		1	22	-	711	1610	661	107.5%
5/1		U	N/A	N/A	-		-	-	-	1122	Inf	Inf	0.0%
5/2		U	N/A	N/A	-		-	-	-	711	Inf	Inf	0.0%
6/1	Left	U	N/A	N/A	D		1	22	-	569	1295	532	107.0%
7/1	Ahead Ahead2	U	N/A	N/A	-		-	-	-	760	Inf	Inf	0.0%
8/1	Right	U	N/A	N/A	E		1	8	-	191	950	153	125.1%
9/1	Right	U	N/A	N/A	C		1	10	-	167	795	156	106.9%
10/1	Ahead Ahead2	U	N/A	N/A	-		-	-	-	873	Inf	Inf	0.0%

Full Input Data And Results

Item	Arriving (pcu)	Leaving (pcu)	Turners In Gaps (pcu)	Turners When Unopposed (pcu)	Turners In Intergreen (pcu)	Uniform Delay (pcuHr)	Rand + Oversat Delay (pcuHr)	Storage Area Uniform Delay (pcuHr)	Total Delay (pcuHr)	Av. Delay Per PCU (s/pcu)	Max. Back of Uniform Queue (pcu)	Rand + Oversat Queue (pcu)	Mean Max Queue (pcu)
Network: Existing junction model	-	-	0	0	0	18.8	131.9	0.0	150.7	-	-	-	-
A140 Ipswich Rd / B1113	-	-	0	0	0	18.8	131.9	0.0	150.7	-	-	-	-
1/1	706	704	-	-	-	1.9	13.9	-	15.8	80.6	11.0	13.9	24.9
2/1	324	324	-	-	-	0.0	0.0	-	0.0	0.0	0.0	0.0	0.0
3/1	856	856	-	-	-	0.0	0.0	-	0.0	0.0	0.0	0.0	0.0
4/1	734	682	-	-	-	4.7	31.9	-	36.6	179.5	12.2	31.9	44.1
4/2	711	661	-	-	-	4.6	30.7	-	35.2	178.4	11.8	30.7	42.5
5/1	1046	1046	-	-	-	0.0	0.0	-	0.0	0.0	0.0	0.0	0.0
5/2	661	661	-	-	-	0.0	0.0	-	0.0	0.0	0.0	0.0	0.0
6/1	569	532	-	-	-	3.9	24.4	-	28.2	178.7	9.5	24.4	33.9
7/1	760	760	-	-	-	0.0	0.0	-	0.0	0.0	0.0	0.0	0.0
8/1	191	153	-	-	-	2.5	21.4	-	23.9	449.6	2.0	10.7	12.7
9/1	167	156	-	-	-	1.3	9.7	-	11.0	236.7	2.8	9.7	12.5
10/1	873	873	-	-	-	0.0	0.0	-	0.0	0.0	0.0	0.0	0.0
C1			PRC for Signalled Lanes (%): -39.0		PRC Over All Lanes (%): -39.0		Total Delay for Signalled Lanes (pcuHr): 150.71		Total Delay Over All Lanes(pcuHr): 150.71		Cycle Time (s): 56		

Full Input Data And Results

Scenario 10: 'Copy of 2022 PM Peak + Proposed Development' (FG6: '2022 PM Peak Hour + Proposed Development', Plan 1: 'Network Control Plan 1')

Stage Sequence Diagram

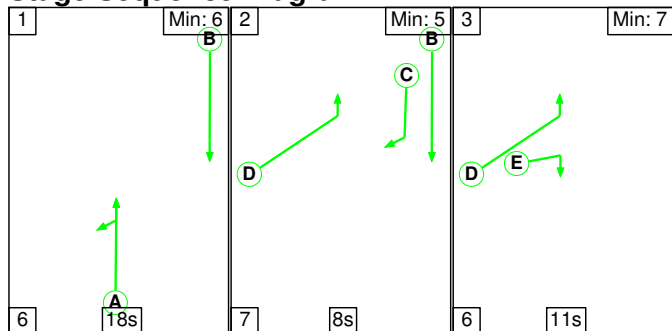

Stage Timings

Stage	1	2	3
Duration	18	8	11
Change Point	0	24	39

Signal Timings Diagram

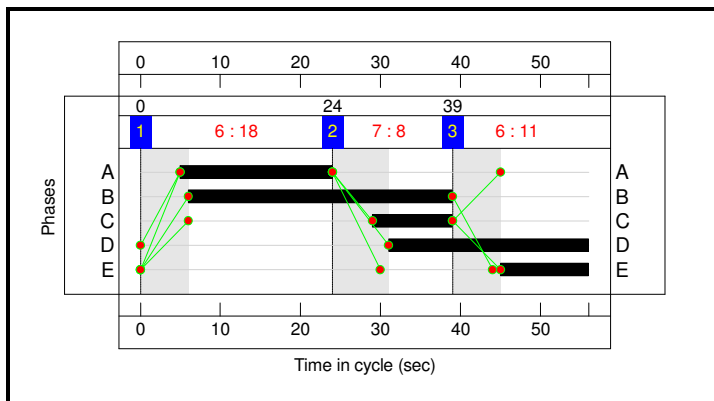

Full Input Data And Results
Network Layout Diagram

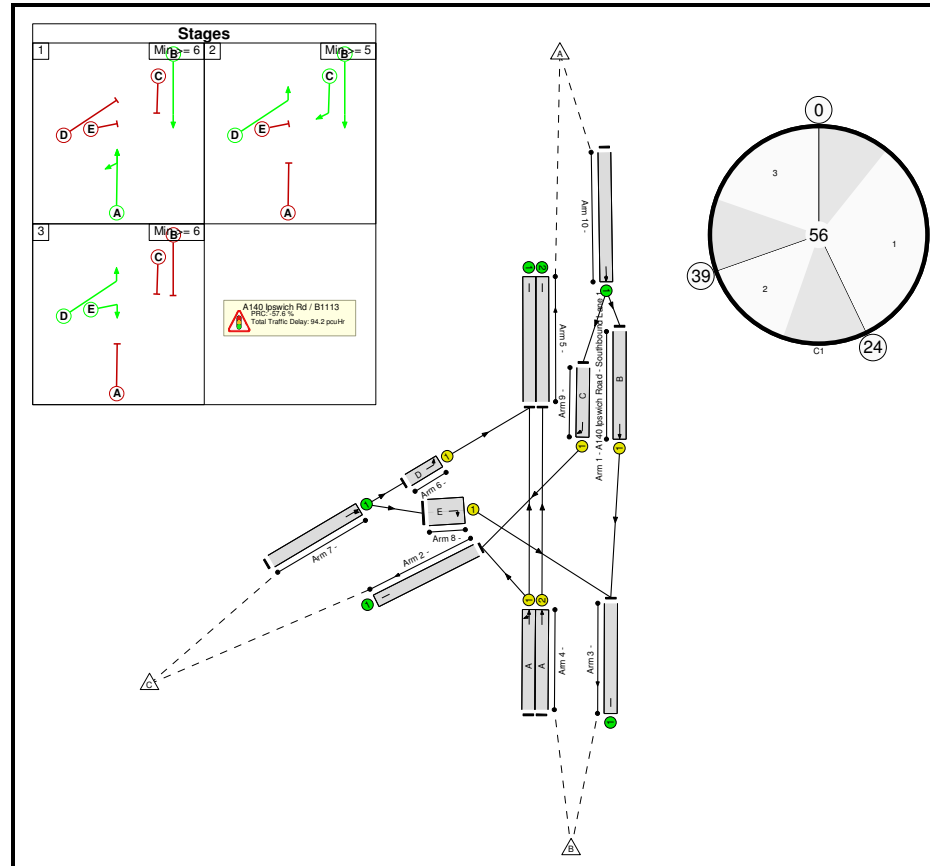

Full Input Data And Results

Network Results

Item	Lane Description	Lane Type	Controller Stream	Position In Filtered Route	Full Phase	Arrow Phase	Num Greens	Total Green (s)	Arrow Green (s)	Demand Flow (pcu)	Sat Flow (pcu/Hr)	Capacity (pcu)	Deg Sat (%)
Network: Existing junction model	-	-	N/A	-	-		-	-	-	-	-	-	141.8%
A140 Ipswich Rd / B1113	-	-	N/A	-	-		-	-	-	-	-	-	141.8%
1/1	A140 Ipswich Road - Southbound Lane 1 Ahead	U	N/A	N/A	B		1	33	-	1112	2010	1220	91.1%
2/1		U	N/A	N/A	-		-	-	-	637	Inf	Inf	0.0%
3/1		U	N/A	N/A	-		-	-	-	1293	Inf	Inf	0.0%
4/1	Left Ahead	U	N/A	N/A	A		1	19	-	233	460	164	141.8%
4/2	Ahead	U	N/A	N/A	A		1	19	-	767	2600	929	82.6%
5/1		U	N/A	N/A	-		-	-	-	275	Inf	Inf	0.0%
5/2		U	N/A	N/A	-		-	-	-	767	Inf	Inf	0.0%
6/1	Left	U	N/A	N/A	D		1	25	-	275	620	288	95.5%
7/1	Ahead Ahead2	U	N/A	N/A	-		-	-	-	456	Inf	Inf	0.0%
8/1	Right	U	N/A	N/A	E		1	11	-	181	890	191	94.9%
9/1	Right	U	N/A	N/A	C		1	10	-	404	1835	360	112.1%
10/1	Ahead Ahead2	U	N/A	N/A	-		-	-	-	1516	Inf	Inf	0.0%

Full Input Data And Results

Item	Arriving (pcu)	Leaving (pcu)	Turners In Gaps (pcu)	Turners When Unopposed (pcu)	Turners In Intergreen (pcu)	Uniform Delay (pcuHr)	Rand + Oversat Delay (pcuHr)	Storage Area Uniform Delay (pcuHr)	Total Delay (pcuHr)	Av. Delay Per PCU (s/pcu)	Max. Back of Uniform Queue (pcu)	Rand + Oversat Queue (pcu)	Mean Max Queue (pcu)
Network: Existing junction model	-	-	0	0	0	15.1	79.1	0.0	94.2	-	-	-	-
A140 Ipswich Rd / B1113	-	-	0	0	0	15.1	79.1	0.0	94.2	-	-	-	-
1/1	1112	1112	-	-	-	3.0	4.7	-	7.7	25.0	15.1	4.7	19.9
2/1	525	525	-	-	-	0.0	0.0	-	0.0	0.0	0.0	0.0	0.0
3/1	1293	1293	-	-	-	0.0	0.0	-	0.0	0.0	0.0	0.0	0.0
4/1	233	164	-	-	-	3.0	36.0	-	39.0	602.0	4.7	36.0	40.7
4/2	767	767	-	-	-	3.5	2.3	-	5.8	27.2	10.9	2.3	13.2
5/1	275	275	-	-	-	0.0	0.0	-	0.0	0.0	0.0	0.0	0.0
5/2	767	767	-	-	-	0.0	0.0	-	0.0	0.0	0.0	0.0	0.0
6/1	275	275	-	-	-	1.1	5.7	-	6.8	88.8	4.0	5.7	9.7
7/1	456	456	-	-	-	0.0	0.0	-	0.0	0.0	0.0	0.0	0.0
8/1	181	181	-	-	-	1.1	4.7	-	5.8	115.6	1.4	2.4	3.7
9/1	404	360	-	-	-	3.4	25.7	-	29.2	259.8	7.0	25.7	32.7
10/1	1516	1516	-	-	-	0.0	0.0	-	0.0	0.0	0.0	0.0	0.0
C1 PRC for Signalled Lanes (%): -57.6 Total Delay for Signalled Lanes (pcuHr): 94.22 Cycle Time (s): 56 PRC Over All Lanes (%): -57.6 Total Delay Over All Lanes(pcuHr): 94.22													

Appendix F Roundabout Operational Assessments

Junctions 9
ARCADY 9 - Roundabout Module
Version: 9.0.2.5947 © Copyright TRL Limited, 2017
For sales and distribution information, program advice and maintenance, contact TRL: +44 (0)1344 770558 software@trl.co.uk www.trlsoftware.co.uk
The users of this computer program for the solution of an engineering problem are in no way relieved of their responsibility for the correctness of the solution

Filename: A148_B1110_B1149 Junction.j9
 Path: P:\JNY8772 - Hornsea Project 3\Transport\Arcady
 Report generation date: 13/04/2018 15:21:29

- »2017, AM
- »2017, PM
- »2022, AM
- »2022, PM
- »2022 + Construction HGVs, AM
- »2022 + Construction HGVs, PM

Summary of junction performance

	AM			PM		
	Queue (Veh)	Delay (s)	RFC	Queue (Veh)	Delay (s)	RFC
2017						
1 - A148 (E)	0.4	3.32	0.28	0.8	4.49	0.45
2 - B1149	0.5	3.43	0.33	0.2	2.96	0.19
3 - B1110	0.2	4.15	0.18	0.1	3.29	0.10
4 - A148 (N)	0.4	3.47	0.26	0.7	3.72	0.40
2022						
1 - A148 (E)	0.4	3.46	0.31	1.0	4.96	0.49
2 - B1149	0.6	3.66	0.36	0.3	3.09	0.21
3 - B1110	0.3	4.43	0.21	0.1	3.42	0.11
4 - A148 (N)	0.4	3.66	0.29	0.8	4.00	0.44
2022 + Construction HGVs						
1 - A148 (E)	0.5	3.52	0.32	1.1	5.44	0.52
2 - B1149	0.6	3.77	0.38	0.3	3.44	0.24
3 - B1110	0.3	4.54	0.21	0.1	3.55	0.12
4 - A148 (N)	0.5	3.74	0.31	0.9	4.55	0.48

Values shown are the highest values encountered over all time segments. Delay is the maximum value of average delay per arriving vehicle.

File summary

File Description

Title	A148_B1110_B1149 Junction
Location	Holt
Site number	
Date	09/03/2018
Version	
Status	(new file)
Identifier	
Client	
Jobnumber	
Enumerator	EUR\charles.montgomerie
Description	

Units

Distance units	Speed units	Traffic units input	Traffic units results	Flow units	Average delay units	Total delay units	Rate of delay units
m	kph	Veh	Veh	perHour	s	-Min	perMin

Analysis Options

Calculate Queue Percentiles	Calculate residual capacity	RFC Threshold	Average Delay threshold (s)	Queue threshold (PCU)
		0.85	36.00	20.00

Demand Set Summary

ID	Scenario name	Time Period name	Traffic profile type	Start time (HH:mm)	Finish time (HH:mm)	Time segment length (min)
D1	2017	AM	ONE HOUR	07:30	09:00	15
D2	2017	PM	ONE HOUR	16:15	17:45	15
D3	2022	AM	ONE HOUR	07:30	09:00	15
D4	2022	PM	ONE HOUR	16:15	17:45	15
D5	2022 + Construction HGVs	AM	ONE HOUR	07:30	09:00	15
D6	2022 + Construction HGVs	PM	ONE HOUR	16:15	17:45	15

Analysis Set Details

ID	Network flow scaling factor (%)
A1	100.000

2017, AM

Data Errors and Warnings

No errors or warnings

Junction Network

Junctions

Junction	Name	Junction Type	Arm order	Junction Delay (s)	Junction LOS
1	untitled	Standard Roundabout	1, 2, 3, 4	3.50	A

Junction Network Options

Driving side	Lighting
Left	Normal/unknown

Arms

Arms

Arm	Name	Description
1	A148 (E)	
2	B1149	
3	B1110	
4	A148 (N)	

Roundabout Geometry

Arm	V - Approach road half-width (m)	E - Entry width (m)	I' - Effective flare length (m)	R - Entry radius (m)	D - Inscribed circle diameter (m)	PHI - Conflict (entry) angle (deg)	Exit only
1 - A148 (E)	3.75	8.00	14.0	10.0	35.0	26.5	
2 - B1149	3.75	6.50	26.5	20.0	35.0	15.5	
3 - B1110	3.75	7.00	13.5	7.5	35.0	25.0	
4 - A148 (N)	3.75	6.50	15.0	40.0	40.0	14.5	

Slope / Intercept / Capacity

Roundabout Slope and Intercept used in model

Arm	Final slope	Final intercept (PCU/hr)
1 - A148 (E)	0.645	1724
2 - B1149	0.698	1850
3 - B1110	0.608	1584
4 - A148 (N)	0.684	1791

The slope and intercept shown above include any corrections and adjustments.

Traffic Demand

Demand Set Details

ID	Scenario name	Time Period name	Traffic profile type	Start time (HH:mm)	Finish time (HH:mm)	Time segment length (min)
D1	2017	AM	ONE HOUR	07:30	09:00	15

Vehicle mix source	PCU Factor for a HV (PCU)
HV Percentages	2.00

Demand overview (Traffic)

Arm	Linked arm	Use O-D data	Average Demand (Veh/hr)	Scaling Factor (%)
1 - A148 (E)		✓	386	100.000
2 - B1149		✓	465	100.000
3 - B1110		✓	177	100.000
4 - A148 (N)		✓	337	100.000

Origin-Destination Data

Demand (Veh/hr)

		To			
		1 - A148 (E)	2 - B1149	3 - B1110	4 - A148 (N)
From	1 - A148 (E)	0	102	56	228
	2 - B1149	225	0	16	224
	3 - B1110	117	13	0	47
	4 - A148 (N)	210	105	22	0

Vehicle Mix

Heavy Vehicle Percentages

		To			
		1 - A148 (E)	2 - B1149	3 - B1110	4 - A148 (N)
From	1 - A148 (E)	0	9	4	7
	2 - B1149	3	0	6	2
	3 - B1110	3	15	0	6
	4 - A148 (N)	8	7	5	0

Results

Results Summary for whole modelled period

Arm	Max RFC	Max delay (s)	Max Queue (Veh)	Max LOS
1 - A148 (E)	0.28	3.32	0.4	A
2 - B1149	0.33	3.43	0.5	A
3 - B1110	0.18	4.15	0.2	A
4 - A148 (N)	0.26	3.47	0.4	A

Main Results for each time segment

07:30 - 07:45

Arm	Total Demand (Veh/hr)	Circulating flow (Veh/hr)	Capacity (Veh/hr)	RFC	Throughput (Veh/hr)	End queue (Veh)	Delay (s)	LOS
1 - A148 (E)	291	105	1542	0.189	290	0.2	2.874	A
2 - B1149	350	230	1637	0.214	349	0.3	2.791	A
3 - B1110	133	508	1206	0.110	133	0.1	3.352	A
4 - A148 (N)	254	266	1491	0.170	253	0.2	2.906	A

07:45 - 08:00

Arm	Total Demand (Veh/hr)	Circulating flow (Veh/hr)	Capacity (Veh/hr)	RFC	Throughput (Veh/hr)	End queue (Veh)	Delay (s)	LOS
1 - A148 (E)	347	126	1528	0.227	347	0.3	3.047	A
2 - B1149	418	275	1605	0.261	418	0.4	3.033	A
3 - B1110	159	608	1146	0.139	159	0.2	3.648	A
4 - A148 (N)	303	319	1457	0.208	303	0.3	3.119	A

08:00 - 08:15

Arm	Total Demand (Veh/hr)	Circulating flow (Veh/hr)	Capacity (Veh/hr)	RFC	Throughput (Veh/hr)	End queue (Veh)	Delay (s)	LOS
1 - A148 (E)	425	154	1510	0.281	425	0.4	3.317	A
2 - B1149	512	337	1560	0.328	511	0.5	3.431	A
3 - B1110	195	745	1063	0.183	195	0.2	4.144	A
4 - A148 (N)	371	390	1410	0.263	371	0.4	3.465	A

08:15 - 08:30

Arm	Total Demand (Veh/hr)	Circulating flow (Veh/hr)	Capacity (Veh/hr)	RFC	Throughput (Veh/hr)	End queue (Veh)	Delay (s)	LOS
1 - A148 (E)	425	154	1510	0.282	425	0.4	3.317	A
2 - B1149	512	337	1560	0.328	512	0.5	3.435	A
3 - B1110	195	745	1063	0.183	195	0.2	4.148	A
4 - A148 (N)	371	391	1409	0.263	371	0.4	3.466	A

08:30 - 08:45

Arm	Total Demand (Veh/hr)	Circulating flow (Veh/hr)	Capacity (Veh/hr)	RFC	Throughput (Veh/hr)	End queue (Veh)	Delay (s)	LOS
1 - A148 (E)	347	126	1528	0.227	347	0.3	3.049	A
2 - B1149	418	275	1604	0.261	419	0.4	3.037	A
3 - B1110	159	609	1145	0.139	159	0.2	3.656	A
4 - A148 (N)	303	320	1456	0.208	303	0.3	3.125	A

08:45 - 09:00

Arm	Total Demand (Veh/hr)	Circulating flow (Veh/hr)	Capacity (Veh/hr)	RFC	Throughput (Veh/hr)	End queue (Veh)	Delay (s)	LOS
1 - A148 (E)	291	105	1541	0.189	291	0.2	2.881	A
2 - B1149	350	231	1637	0.214	350	0.3	2.801	A
3 - B1110	133	510	1205	0.111	133	0.1	3.359	A
4 - A148 (N)	254	268	1490	0.170	254	0.2	2.911	A

2017, PM

Data Errors and Warnings

No errors or warnings

Junction Network

Junctions

Junction	Name	Junction Type	Arm order	Junction Delay (s)	Junction LOS
1	untitled	Standard Roundabout	1, 2, 3, 4	3.86	A

Junction Network Options

Driving side	Lighting
Left	Normal/unknown

Traffic Demand

Demand Set Details

ID	Scenario name	Time Period name	Traffic profile type	Start time (HH:mm)	Finish time (HH:mm)	Time segment length (min)
D2	2017	PM	ONE HOUR	16:15	17:45	15

Vehicle mix source	PCU Factor for a HV (PCU)
HV Percentages	2.00

Demand overview (Traffic)

Arm	Linked arm	Use O-D data	Average Demand (Veh/hr)	Scaling Factor (%)
1 - A148 (E)		✓	589	100.000
2 - B1149		✓	255	100.000
3 - B1110		✓	111	100.000
4 - A148 (N)		✓	583	100.000

Origin-Destination Data

Demand (Veh/hr)

		To			
		1 - A148 (E)	2 - B1149	3 - B1110	4 - A148 (N)
From	1 - A148 (E)	0	219	96	274
	2 - B1149	111	0	7	137
	3 - B1110	76	14	0	21
	4 - A148 (N)	270	258	55	0

Vehicle Mix

Heavy Vehicle Percentages

		To			
		1 - A148 (E)	2 - B1149	3 - B1110	4 - A148 (N)
From	1 - A148 (E)	0	1	2	4
	2 - B1149	0	0	0	2
	3 - B1110	1	0	0	0
	4 - A148 (N)	2	2	0	0

Results

Results Summary for whole modelled period

Arm	Max RFC	Max delay (s)	Max Queue (Veh)	Max LOS
1 - A148 (E)	0.45	4.49	0.8	A
2 - B1149	0.19	2.96	0.2	A
3 - B1110	0.10	3.29	0.1	A
4 - A148 (N)	0.40	3.72	0.7	A

Main Results for each time segment

16:15 - 16:30

Arm	Total Demand (Veh/hr)	Circulating flow (Veh/hr)	Capacity (Veh/hr)	RFC	Throughput (Veh/hr)	End queue (Veh)	Delay (s)	LOS
1 - A148 (E)	443	245	1524	0.291	442	0.4	3.323	A
2 - B1149	192	319	1604	0.120	191	0.1	2.548	A
3 - B1110	84	392	1330	0.063	83	0.1	2.886	A
4 - A148 (N)	439	151	1658	0.265	437	0.4	2.948	A

16:30 - 16:45

Arm	Total Demand (Veh/hr)	Circulating flow (Veh/hr)	Capacity (Veh/hr)	RFC	Throughput (Veh/hr)	End queue (Veh)	Delay (s)	LOS
1 - A148 (E)	529	294	1493	0.355	529	0.5	3.732	A
2 - B1149	229	382	1559	0.147	229	0.2	2.705	A
3 - B1110	100	469	1282	0.078	100	0.1	3.043	A
4 - A148 (N)	524	181	1638	0.320	524	0.5	3.229	A

16:45 - 17:00

Arm	Total Demand (Veh/hr)	Circulating flow (Veh/hr)	Capacity (Veh/hr)	RFC	Throughput (Veh/hr)	End queue (Veh)	Delay (s)	LOS
1 - A148 (E)	648	360	1451	0.447	647	0.8	4.475	A
2 - B1149	281	467	1499	0.187	281	0.2	2.955	A
3 - B1110	122	574	1217	0.100	122	0.1	3.286	A
4 - A148 (N)	642	221	1610	0.399	641	0.7	3.710	A

17:00 - 17:15

Arm	Total Demand (Veh/hr)	Circulating flow (Veh/hr)	Capacity (Veh/hr)	RFC	Throughput (Veh/hr)	End queue (Veh)	Delay (s)	LOS
1 - A148 (E)	648	360	1451	0.447	648	0.8	4.487	A
2 - B1149	281	468	1498	0.187	281	0.2	2.956	A
3 - B1110	122	575	1217	0.100	122	0.1	3.288	A
4 - A148 (N)	642	221	1610	0.399	642	0.7	3.716	A

17:15 - 17:30

Arm	Total Demand (Veh/hr)	Circulating flow (Veh/hr)	Capacity (Veh/hr)	RFC	Throughput (Veh/hr)	End queue (Veh)	Delay (s)	LOS
1 - A148 (E)	529	294	1493	0.355	531	0.6	3.747	A
2 - B1149	229	383	1559	0.147	229	0.2	2.708	A
3 - B1110	100	470	1282	0.078	100	0.1	3.048	A
4 - A148 (N)	524	181	1638	0.320	525	0.5	3.239	A

17:30 - 17:45

Arm	Total Demand (Veh/hr)	Circulating flow (Veh/hr)	Capacity (Veh/hr)	RFC	Throughput (Veh/hr)	End queue (Veh)	Delay (s)	LOS
1 - A148 (E)	443	246	1523	0.291	444	0.4	3.339	A
2 - B1149	192	320	1603	0.120	192	0.1	2.551	A
3 - B1110	84	393	1329	0.063	84	0.1	2.889	A
4 - A148 (N)	439	151	1657	0.265	439	0.4	2.958	A

2022, AM

Data Errors and Warnings

No errors or warnings

Junction Network

Junctions

Junction	Name	Junction Type	Arm order	Junction Delay (s)	Junction LOS
1	untitled	Standard Roundabout	1, 2, 3, 4	3.70	A

Junction Network Options

Driving side	Lighting
Left	Normal/unknown

Traffic Demand

Demand Set Details

ID	Scenario name	Time Period name	Traffic profile type	Start time (HH:mm)	Finish time (HH:mm)	Time segment length (min)
D3	2022	AM	ONE HOUR	07:30	09:00	15

Vehicle mix source	PCU Factor for a HV (PCU)
HV Percentages	2.00

Demand overview (Traffic)

Arm	Linked arm	Use O-D data	Average Demand (Veh/hr)	Scaling Factor (%)
1 - A148 (E)		✓	420	100.000
2 - B1149		✓	505	100.000
3 - B1110		✓	192	100.000
4 - A148 (N)		✓	366	100.000

Origin-Destination Data

Demand (Veh/hr)

		To			
		1 - A148 (E)	2 - B1149	3 - B1110	4 - A148 (N)
From	1 - A148 (E)	0	111	61	248
	2 - B1149	245	0	17	243
	3 - B1110	127	14	0	51
	4 - A148 (N)	228	114	24	0

Vehicle Mix

Heavy Vehicle Percentages

		To			
		1 - A148 (E)	2 - B1149	3 - B1110	4 - A148 (N)
From	1 - A148 (E)	0	9	4	7
	2 - B1149	3	0	6	2
	3 - B1110	3	15	0	6
	4 - A148 (N)	8	7	5	0

Results

Results Summary for whole modelled period

Arm	Max RFC	Max delay (s)	Max Queue (Veh)	Max LOS
1 - A148 (E)	0.31	3.46	0.4	A
2 - B1149	0.36	3.66	0.6	A
3 - B1110	0.21	4.43	0.3	A
4 - A148 (N)	0.29	3.66	0.4	A

Main Results for each time segment

07:30 - 07:45

Arm	Total Demand (Veh/hr)	Circulating flow (Veh/hr)	Capacity (Veh/hr)	RFC	Throughput (Veh/hr)	End queue (Veh)	Delay (s)	LOS
1 - A148 (E)	316	114	1536	0.206	315	0.3	2.946	A
2 - B1149	380	250	1623	0.234	379	0.3	2.892	A
3 - B1110	145	552	1179	0.123	144	0.1	3.475	A
4 - A148 (N)	276	290	1476	0.187	275	0.2	2.995	A

07:45 - 08:00

Arm	Total Demand (Veh/hr)	Circulating flow (Veh/hr)	Capacity (Veh/hr)	RFC	Throughput (Veh/hr)	End queue (Veh)	Delay (s)	LOS
1 - A148 (E)	378	137	1521	0.248	377	0.3	3.147	A
2 - B1149	454	299	1587	0.286	454	0.4	3.176	A
3 - B1110	173	661	1114	0.155	172	0.2	3.824	A
4 - A148 (N)	329	347	1438	0.229	329	0.3	3.244	A

08:00 - 08:15

Arm	Total Demand (Veh/hr)	Circulating flow (Veh/hr)	Capacity (Veh/hr)	RFC	Throughput (Veh/hr)	End queue (Veh)	Delay (s)	LOS
1 - A148 (E)	462	167	1501	0.308	462	0.4	3.461	A
2 - B1149	556	366	1539	0.361	555	0.6	3.660	A
3 - B1110	211	809	1024	0.206	211	0.3	4.428	A
4 - A148 (N)	403	424	1387	0.290	403	0.4	3.653	A

08:15 - 08:30

Arm	Total Demand (Veh/hr)	Circulating flow (Veh/hr)	Capacity (Veh/hr)	RFC	Throughput (Veh/hr)	End queue (Veh)	Delay (s)	LOS
1 - A148 (E)	462	167	1501	0.308	462	0.4	3.464	A
2 - B1149	556	367	1538	0.361	556	0.6	3.664	A
3 - B1110	211	810	1023	0.207	211	0.3	4.433	A
4 - A148 (N)	403	425	1387	0.291	403	0.4	3.657	A

08:30 - 08:45

Arm	Total Demand (Veh/hr)	Circulating flow (Veh/hr)	Capacity (Veh/hr)	RFC	Throughput (Veh/hr)	End queue (Veh)	Delay (s)	LOS
1 - A148 (E)	378	137	1521	0.248	378	0.3	3.152	A
2 - B1149	454	300	1587	0.286	455	0.4	3.181	A
3 - B1110	173	663	1113	0.155	173	0.2	3.833	A
4 - A148 (N)	329	348	1438	0.229	329	0.3	3.251	A

08:45 - 09:00

Arm	Total Demand (Veh/hr)	Circulating flow (Veh/hr)	Capacity (Veh/hr)	RFC	Throughput (Veh/hr)	End queue (Veh)	Delay (s)	LOS
1 - A148 (E)	316	115	1535	0.206	316	0.3	2.953	A
2 - B1149	380	251	1622	0.234	381	0.3	2.902	A
3 - B1110	145	555	1178	0.123	145	0.1	3.484	A
4 - A148 (N)	276	291	1475	0.187	276	0.2	3.001	A

2022, PM

Data Errors and Warnings

No errors or warnings

Junction Network

Junctions

Junction	Name	Junction Type	Arm order	Junction Delay (s)	Junction LOS
1	untitled	Standard Roundabout	1, 2, 3, 4	4.18	A

Junction Network Options

Driving side	Lighting
Left	Normal/unknown

Traffic Demand

Demand Set Details

ID	Scenario name	Time Period name	Traffic profile type	Start time (HH:mm)	Finish time (HH:mm)	Time segment length (min)
D4	2022	PM	ONE HOUR	16:15	17:45	15

Vehicle mix source	PCU Factor for a HV (PCU)
HV Percentages	2.00

Demand overview (Traffic)

Arm	Linked arm	Use O-D data	Average Demand (Veh/hr)	Scaling Factor (%)
1 - A148 (E)		✓	640	100.000
2 - B1149		✓	278	100.000
3 - B1110		✓	121	100.000
4 - A148 (N)		✓	633	100.000

Origin-Destination Data

Demand (Veh/hr)

		To			
		1 - A148 (E)	2 - B1149	3 - B1110	4 - A148 (N)
From	1 - A148 (E)	0	238	104	298
	2 - B1149	121	0	8	149
	3 - B1110	83	15	0	23
	4 - A148 (N)	293	280	60	0

Vehicle Mix

Heavy Vehicle Percentages

		To			
		1 - A148 (E)	2 - B1149	3 - B1110	4 - A148 (N)
From	1 - A148 (E)	0	1	2	4
	2 - B1149	0	0	0	2
	3 - B1110	1	0	0	0
	4 - A148 (N)	2	2	0	0

Results

Results Summary for whole modelled period

Arm	Max RFC	Max delay (s)	Max Queue (Veh)	Max LOS
1 - A148 (E)	0.49	4.96	1.0	A
2 - B1149	0.21	3.09	0.3	A
3 - B1110	0.11	3.42	0.1	A
4 - A148 (N)	0.44	4.00	0.8	A

Main Results for each time segment

16:15 - 16:30

Arm	Total Demand (Veh/hr)	Circulating flow (Veh/hr)	Capacity (Veh/hr)	RFC	Throughput (Veh/hr)	End queue (Veh)	Delay (s)	LOS
1 - A148 (E)	482	266	1510	0.319	480	0.5	3.487	A
2 - B1149	209	346	1584	0.132	209	0.2	2.615	A
3 - B1110	91	426	1309	0.070	91	0.1	2.955	A
4 - A148 (N)	477	164	1649	0.289	475	0.4	3.063	A

16:30 - 16:45

Arm	Total Demand (Veh/hr)	Circulating flow (Veh/hr)	Capacity (Veh/hr)	RFC	Throughput (Veh/hr)	End queue (Veh)	Delay (s)	LOS
1 - A148 (E)	575	319	1477	0.390	575	0.6	3.987	A
2 - B1149	250	415	1536	0.163	250	0.2	2.798	A
3 - B1110	109	510	1257	0.087	109	0.1	3.135	A
4 - A148 (N)	569	197	1627	0.350	569	0.5	3.399	A

16:45 - 17:00

Arm	Total Demand (Veh/hr)	Circulating flow (Veh/hr)	Capacity (Veh/hr)	RFC	Throughput (Veh/hr)	End queue (Veh)	Delay (s)	LOS
1 - A148 (E)	705	390	1431	0.492	703	1.0	4.936	A
2 - B1149	306	508	1470	0.208	306	0.3	3.092	A
3 - B1110	133	625	1186	0.112	133	0.1	3.419	A
4 - A148 (N)	697	241	1597	0.436	696	0.8	3.991	A

17:00 - 17:15

Arm	Total Demand (Veh/hr)	Circulating flow (Veh/hr)	Capacity (Veh/hr)	RFC	Throughput (Veh/hr)	End queue (Veh)	Delay (s)	LOS
1 - A148 (E)	705	391	1431	0.492	705	1.0	4.956	A
2 - B1149	306	509	1469	0.208	306	0.3	3.094	A
3 - B1110	133	625	1185	0.112	133	0.1	3.420	A
4 - A148 (N)	697	241	1597	0.436	697	0.8	3.999	A

17:15 - 17:30

Arm	Total Demand (Veh/hr)	Circulating flow (Veh/hr)	Capacity (Veh/hr)	RFC	Throughput (Veh/hr)	End queue (Veh)	Delay (s)	LOS
1 - A148 (E)	575	320	1476	0.390	577	0.6	4.007	A
2 - B1149	250	416	1535	0.163	250	0.2	2.804	A
3 - B1110	109	511	1256	0.087	109	0.1	3.138	A
4 - A148 (N)	569	197	1627	0.350	570	0.5	3.411	A

17:30 - 17:45

Arm	Total Demand (Veh/hr)	Circulating flow (Veh/hr)	Capacity (Veh/hr)	RFC	Throughput (Veh/hr)	End queue (Veh)	Delay (s)	LOS
1 - A148 (E)	482	268	1510	0.319	483	0.5	3.508	A
2 - B1149	209	348	1583	0.132	209	0.2	2.620	A
3 - B1110	91	428	1308	0.070	91	0.1	2.961	A
4 - A148 (N)	477	165	1648	0.289	477	0.4	3.076	A

2022 + Construction HGVs, AM

Data Errors and Warnings

No errors or warnings

Junction Network

Junctions

Junction	Name	Junction Type	Arm order	Junction Delay (s)	Junction LOS
1	untitled	Standard Roundabout	1, 2, 3, 4	3.79	A

Junction Network Options

Driving side	Lighting
Left	Normal/unknown

Traffic Demand

Demand Set Details

ID	Scenario name	Time Period name	Traffic profile type	Start time (HH:mm)	Finish time (HH:mm)	Time segment length (min)
D5	2022 + Construction HGVs	AM	ONE HOUR	07:30	09:00	15

Vehicle mix source	PCU Factor for a HV (PCU)
HV Percentages	2.00

Demand overview (Traffic)

Arm	Linked arm	Use O-D data	Average Demand (Veh/hr)	Scaling Factor (%)
1 - A148 (E)		✓	433	100.000
2 - B1149		✓	522	100.000
3 - B1110		✓	192	100.000
4 - A148 (N)		✓	397	100.000

Origin-Destination Data

Demand (Veh/hr)

		To			
		1 - A148 (E)	2 - B1149	3 - B1110	4 - A148 (N)
From	1 - A148 (E)	0	111	61	261
	2 - B1149	245	0	17	260
	3 - B1110	127	14	0	51
	4 - A148 (N)	242	131	24	0

Vehicle Mix

Heavy Vehicle Percentages

		To			
		1 - A148 (E)	2 - B1149	3 - B1110	4 - A148 (N)
From	1 - A148 (E)	0	9	4	6
	2 - B1149	3	0	6	2
	3 - B1110	3	15	0	6
	4 - A148 (N)	7	6	5	0

Results

Results Summary for whole modelled period

Arm	Max RFC	Max delay (s)	Max Queue (Veh)	Max LOS
1 - A148 (E)	0.32	3.52	0.5	A
2 - B1149	0.38	3.77	0.6	A
3 - B1110	0.21	4.54	0.3	A
4 - A148 (N)	0.31	3.74	0.5	A

Main Results for each time segment

07:30 - 07:45

Arm	Total Demand (Veh/hr)	Circulating flow (Veh/hr)	Capacity (Veh/hr)	RFC	Throughput (Veh/hr)	End queue (Veh)	Delay (s)	LOS
1 - A148 (E)	326	127	1537	0.212	325	0.3	2.967	A
2 - B1149	393	260	1617	0.243	392	0.3	2.935	A
3 - B1110	145	575	1167	0.124	144	0.1	3.517	A
4 - A148 (N)	299	290	1489	0.201	298	0.3	3.019	A

07:45 - 08:00

Arm	Total Demand (Veh/hr)	Circulating flow (Veh/hr)	Capacity (Veh/hr)	RFC	Throughput (Veh/hr)	End queue (Veh)	Delay (s)	LOS
1 - A148 (E)	389	152	1521	0.256	389	0.3	3.181	A
2 - B1149	469	311	1580	0.297	469	0.4	3.239	A
3 - B1110	173	688	1099	0.157	172	0.2	3.887	A
4 - A148 (N)	357	347	1451	0.246	357	0.3	3.289	A

08:00 - 08:15

Arm	Total Demand (Veh/hr)	Circulating flow (Veh/hr)	Capacity (Veh/hr)	RFC	Throughput (Veh/hr)	End queue (Veh)	Delay (s)	LOS
1 - A148 (E)	477	186	1499	0.318	476	0.5	3.519	A
2 - B1149	575	381	1530	0.376	574	0.6	3.763	A
3 - B1110	211	842	1006	0.210	211	0.3	4.528	A
4 - A148 (N)	437	424	1400	0.312	437	0.5	3.736	A

08:15 - 08:30

Arm	Total Demand (Veh/hr)	Circulating flow (Veh/hr)	Capacity (Veh/hr)	RFC	Throughput (Veh/hr)	End queue (Veh)	Delay (s)	LOS
1 - A148 (E)	477	186	1499	0.318	477	0.5	3.522	A
2 - B1149	575	381	1530	0.376	575	0.6	3.767	A
3 - B1110	211	843	1005	0.210	211	0.3	4.535	A
4 - A148 (N)	437	425	1399	0.312	437	0.5	3.741	A

08:30 - 08:45

Arm	Total Demand (Veh/hr)	Circulating flow (Veh/hr)	Capacity (Veh/hr)	RFC	Throughput (Veh/hr)	End queue (Veh)	Delay (s)	LOS
1 - A148 (E)	389	152	1520	0.256	390	0.3	3.184	A
2 - B1149	469	311	1580	0.297	470	0.4	3.244	A
3 - B1110	173	690	1098	0.157	173	0.2	3.893	A
4 - A148 (N)	357	348	1451	0.246	357	0.3	3.293	A

08:45 - 09:00

Arm	Total Demand (Veh/hr)	Circulating flow (Veh/hr)	Capacity (Veh/hr)	RFC	Throughput (Veh/hr)	End queue (Veh)	Delay (s)	LOS
1 - A148 (E)	326	127	1536	0.212	326	0.3	2.974	A
2 - B1149	393	261	1616	0.243	393	0.3	2.946	A
3 - B1110	145	577	1165	0.124	145	0.1	3.526	A
4 - A148 (N)	299	291	1488	0.201	299	0.3	3.027	A

2022 + Construction HGVs, PM

Data Errors and Warnings

No errors or warnings

Junction Network

Junctions

Junction	Name	Junction Type	Arm order	Junction Delay (s)	Junction LOS
1	untitled	Standard Roundabout	1, 2, 3, 4	4.62	A

Junction Network Options

Driving side	Lighting
Left	Normal/unknown

Traffic Demand

Demand Set Details

ID	Scenario name	Time Period name	Traffic profile type	Start time (HH:mm)	Finish time (HH:mm)	Time segment length (min)
D6	2022 + Construction HGVs	PM	ONE HOUR	16:15	17:45	15

Vehicle mix source	PCU Factor for a HV (PCU)
HV Percentages	2.00

Demand overview (Traffic)

Arm	Linked arm	Use O-D data	Average Demand (Veh/hr)	Scaling Factor (%)
1 - A148 (E)		✓	653	100.000
2 - B1149		✓	295	100.000
3 - B1110		✓	121	100.000
4 - A148 (N)		✓	664	100.000

Origin-Destination Data

Demand (Veh/hr)

		To			
		1 - A148 (E)	2 - B1149	3 - B1110	4 - A148 (N)
From	1 - A148 (E)	0	238	104	311
	2 - B1149	121	0	8	166
	3 - B1110	83	15	0	23
	4 - A148 (N)	307	297	60	0

Vehicle Mix

Heavy Vehicle Percentages

		To			
		1 - A148 (E)	2 - B1149	3 - B1110	4 - A148 (N)
From	1 - A148 (E)	0	1	2	8
	2 - B1149	0	0	0	12
	3 - B1110	1	0	0	0
	4 - A148 (N)	7	8	0	0

Results

Results Summary for whole modelled period

Arm	Max RFC	Max delay (s)	Max Queue (Veh)	Max LOS
1 - A148 (E)	0.52	5.44	1.1	A
2 - B1149	0.24	3.44	0.3	A
3 - B1110	0.12	3.55	0.1	A
4 - A148 (N)	0.48	4.55	0.9	A

Main Results for each time segment

16:15 - 16:30

Arm	Total Demand (Veh/hr)	Circulating flow (Veh/hr)	Capacity (Veh/hr)	RFC	Throughput (Veh/hr)	End queue (Veh)	Delay (s)	LOS
1 - A148 (E)	492	279	1466	0.335	490	0.5	3.678	A
2 - B1149	222	356	1487	0.149	221	0.2	2.842	A
3 - B1110	91	449	1282	0.071	91	0.1	3.022	A
4 - A148 (N)	500	164	1571	0.318	498	0.5	3.348	A

16:30 - 16:45

Arm	Total Demand (Veh/hr)	Circulating flow (Veh/hr)	Capacity (Veh/hr)	RFC	Throughput (Veh/hr)	End queue (Veh)	Delay (s)	LOS
1 - A148 (E)	587	334	1430	0.410	586	0.7	4.262	A
2 - B1149	265	426	1439	0.184	265	0.2	3.066	A
3 - B1110	109	537	1224	0.089	109	0.1	3.226	A
4 - A148 (N)	597	197	1551	0.385	596	0.6	3.770	A

16:45 - 17:00

Arm	Total Demand (Veh/hr)	Circulating flow (Veh/hr)	Capacity (Veh/hr)	RFC	Throughput (Veh/hr)	End queue (Veh)	Delay (s)	LOS
1 - A148 (E)	719	409	1381	0.521	717	1.1	5.413	A
2 - B1149	325	522	1373	0.237	324	0.3	3.433	A
3 - B1110	133	657	1146	0.116	133	0.1	3.553	A
4 - A148 (N)	731	241	1522	0.480	730	0.9	4.537	A

17:00 - 17:15

Arm	Total Demand (Veh/hr)	Circulating flow (Veh/hr)	Capacity (Veh/hr)	RFC	Throughput (Veh/hr)	End queue (Veh)	Delay (s)	LOS
1 - A148 (E)	719	410	1381	0.521	719	1.1	5.440	A
2 - B1149	325	523	1372	0.237	325	0.3	3.435	A
3 - B1110	133	658	1146	0.116	133	0.1	3.555	A
4 - A148 (N)	731	241	1522	0.480	731	0.9	4.550	A

17:15 - 17:30

Arm	Total Demand (Veh/hr)	Circulating flow (Veh/hr)	Capacity (Veh/hr)	RFC	Throughput (Veh/hr)	End queue (Veh)	Delay (s)	LOS
1 - A148 (E)	587	335	1430	0.411	589	0.7	4.289	A
2 - B1149	265	428	1438	0.184	266	0.2	3.073	A
3 - B1110	109	539	1223	0.089	109	0.1	3.230	A
4 - A148 (N)	597	197	1550	0.385	598	0.6	3.783	A

17:30 - 17:45

Arm	Total Demand (Veh/hr)	Circulating flow (Veh/hr)	Capacity (Veh/hr)	RFC	Throughput (Veh/hr)	End queue (Veh)	Delay (s)	LOS
1 - A148 (E)	492	280	1465	0.335	492	0.5	3.704	A
2 - B1149	222	358	1486	0.149	222	0.2	2.850	A
3 - B1110	91	451	1280	0.071	91	0.1	3.026	A
4 - A148 (N)	500	165	1571	0.318	501	0.5	3.366	A

Junctions 9
ARCADY 9 - Roundabout Module
Version: 9.0.2.5947 © Copyright TRL Limited, 2017
For sales and distribution information, program advice and maintenance, contact TRL: +44 (0)1344 770558 software@trl.co.uk www.trlsoftware.co.uk
The users of this computer program for the solution of an engineering problem are in no way relieved of their responsibility for the correctness of the solution

Filename: B1145_B1149 junction.j9
 Path: P:\JNY8772 - Hornsea Project 3\Transport\Arcady
 Report generation date: 13/04/2018 15:27:42

- »2017, AM
- »2017, PM
- »2022, AM
- »2022, PM
- »2022 + Construction HGVs, AM
- »2022 + Construction HGVs, PM

Summary of junction performance

	AM			PM		
	Queue (Veh)	Delay (s)	RFC	Queue (Veh)	Delay (s)	RFC
2017						
1 - B1145 (E)	0.2	3.27	0.19	0.3	3.27	0.21
2 - B1149 (S)	0.4	3.51	0.27	0.4	3.33	0.26
3 - B1145 (W)	0.2	3.39	0.18	0.2	3.18	0.14
4 - B1149 (N)	0.2	3.33	0.19	0.3	3.31	0.23
2022						
1 - B1145 (E)	0.3	3.40	0.21	0.3	3.41	0.23
2 - B1149 (S)	0.4	3.67	0.29	0.4	3.48	0.29
3 - B1145 (W)	0.2	3.53	0.20	0.2	3.28	0.16
4 - B1149 (N)	0.3	3.45	0.21	0.3	3.44	0.25
2022 + Construction HGVs						
1 - B1145 (E)	0.3	3.49	0.22	0.3	3.59	0.24
2 - B1149 (S)	0.5	3.82	0.32	0.4	3.82	0.31
3 - B1145 (W)	0.3	3.63	0.22	0.3	3.88	0.20
4 - B1149 (N)	0.3	3.70	0.24	0.4	3.89	0.29

Values shown are the highest values encountered over all time segments. Delay is the maximum value of average delay per arriving vehicle.

File summary

File Description

Title	B1149_B1145 Junction
Location	Cawston
Site number	
Date	09/03/2018
Version	
Status	(new file)
Identifier	
Client	
Jobnumber	
Enumerator	EUR\charles.montgomerie
Description	

Units

Distance units	Speed units	Traffic units input	Traffic units results	Flow units	Average delay units	Total delay units	Rate of delay units
m	kph	Veh	Veh	perHour	s	-Min	perMin

Analysis Options

Calculate Queue Percentiles	Calculate residual capacity	RFC Threshold	Average Delay threshold (s)	Queue threshold (PCU)
		0.85	36.00	20.00

Demand Set Summary

ID	Scenario name	Time Period name	Traffic profile type	Start time (HH:mm)	Finish time (HH:mm)	Time segment length (min)
D1	2017	AM	ONE HOUR	07:30	09:00	15
D2	2017	PM	ONE HOUR	16:15	17:45	15
D3	2022	AM	ONE HOUR	07:30	09:00	15
D4	2022	PM	ONE HOUR	16:15	17:45	15
D5	2022 + Construction HGVs	AM	ONE HOUR	07:30	09:00	15
D6	2022 + Construction HGVs	PM	ONE HOUR	16:15	17:45	15

Analysis Set Details

ID	Network flow scaling factor (%)
A1	100.000

2017, AM

Data Errors and Warnings

No errors or warnings

Junction Network

Junctions

Junction	Name	Junction Type	Arm order	Junction Delay (s)	Junction LOS
1	untitled	Standard Roundabout	1, 2, 3, 4	3.39	A

Junction Network Options

Driving side	Lighting
Left	Normal/unknown

Arms

Arms

Arm	Name	Description
1	B1145 (E)	
2	B1149 (S)	
3	B1145 (W)	
4	B1149 (N)	

Roundabout Geometry

Arm	V - Approach road half-width (m)	E - Entry width (m)	I' - Effective flare length (m)	R - Entry radius (m)	D - Inscribed circle diameter (m)	PHI - Conflict (entry) angle (deg)	Exit only
1 - B1145 (E)	3.50	7.00	9.0	27.5	40.0	16.5	
2 - B1149 (S)	3.50	6.50	11.5	25.0	35.0	17.0	
3 - B1145 (W)	3.50	6.00	10.5	27.5	35.0	18.0	
4 - B1149 (N)	3.25	6.00	16.0	27.5	40.0	16.0	

Slope / Intercept / Capacity

Roundabout Slope and Intercept used in model

Arm	Final slope	Final intercept (PCU/hr)
1 - B1145 (E)	0.645	1625
2 - B1149 (S)	0.657	1641
3 - B1145 (W)	0.643	1572
4 - B1149 (N)	0.644	1617

The slope and intercept shown above include any corrections and adjustments.

Traffic Demand

Demand Set Details

ID	Scenario name	Time Period name	Traffic profile type	Start time (HH:mm)	Finish time (HH:mm)	Time segment length (min)
D1	2017	AM	ONE HOUR	07:30	09:00	15

Vehicle mix source	PCU Factor for a HV (PCU)
HV Percentages	2.00

Demand overview (Traffic)

Arm	Linked arm	Use O-D data	Average Demand (Veh/hr)	Scaling Factor (%)
1 - B1145 (E)		✓	239	100.000
2 - B1149 (S)		✓	342	100.000
3 - B1145 (W)		✓	212	100.000
4 - B1149 (N)		✓	233	100.000

Origin-Destination Data

Demand (Veh/hr)

From	To			
	1 - B1145 (E)	2 - B1149 (S)	3 - B1145 (W)	4 - B1149 (N)
1 - B1145 (E)	0	66	147	26
2 - B1149 (S)	77	0	63	202
3 - B1145 (W)	140	59	0	13
4 - B1149 (N)	17	206	10	0

Vehicle Mix

Heavy Vehicle Percentages

From	To			
	1 - B1145 (E)	2 - B1149 (S)	3 - B1145 (W)	4 - B1149 (N)
1 - B1145 (E)	0	3	3	15
2 - B1149 (S)	4	0	6	9
3 - B1145 (W)	4	3	0	0
4 - B1149 (N)	18	5	0	0

Results

Results Summary for whole modelled period

Arm	Max RFC	Max delay (s)	Max Queue (Veh)	Max LOS
1 - B1145 (E)	0.19	3.27	0.2	A
2 - B1149 (S)	0.27	3.51	0.4	A
3 - B1145 (W)	0.18	3.39	0.2	A
4 - B1149 (N)	0.19	3.33	0.2	A

Main Results for each time segment

07:30 - 07:45

Arm	Total Demand (Veh/hr)	Circulating flow (Veh/hr)	Capacity (Veh/hr)	RFC	Throughput (Veh/hr)	End queue (Veh)	Delay (s)	LOS
1 - B1145 (E)	180	206	1425	0.126	179	0.1	2.888	A
2 - B1149 (S)	257	137	1442	0.179	257	0.2	3.037	A
3 - B1145 (W)	160	229	1366	0.117	159	0.1	2.981	A
4 - B1149 (N)	175	207	1398	0.125	175	0.1	2.941	A

07:45 - 08:00

Arm	Total Demand (Veh/hr)	Circulating flow (Veh/hr)	Capacity (Veh/hr)	RFC	Throughput (Veh/hr)	End queue (Veh)	Delay (s)	LOS
1 - B1145 (E)	215	247	1399	0.154	215	0.2	3.040	A
2 - B1149 (S)	307	164	1424	0.216	307	0.3	3.222	A
3 - B1145 (W)	191	274	1335	0.143	190	0.2	3.143	A
4 - B1149 (N)	209	248	1372	0.153	209	0.2	3.095	A

08:00 - 08:15

Arm	Total Demand (Veh/hr)	Circulating flow (Veh/hr)	Capacity (Veh/hr)	RFC	Throughput (Veh/hr)	End queue (Veh)	Delay (s)	LOS
1 - B1145 (E)	263	303	1363	0.193	263	0.2	3.272	A
2 - B1149 (S)	377	201	1401	0.269	376	0.4	3.514	A
3 - B1145 (W)	233	335	1294	0.180	233	0.2	3.393	A
4 - B1149 (N)	257	304	1337	0.192	256	0.2	3.331	A

08:15 - 08:30

Arm	Total Demand (Veh/hr)	Circulating flow (Veh/hr)	Capacity (Veh/hr)	RFC	Throughput (Veh/hr)	End queue (Veh)	Delay (s)	LOS
1 - B1145 (E)	263	303	1363	0.193	263	0.2	3.273	A
2 - B1149 (S)	377	201	1400	0.269	377	0.4	3.514	A
3 - B1145 (W)	233	336	1294	0.180	233	0.2	3.394	A
4 - B1149 (N)	257	304	1337	0.192	257	0.2	3.331	A

08:30 - 08:45

Arm	Total Demand (Veh/hr)	Circulating flow (Veh/hr)	Capacity (Veh/hr)	RFC	Throughput (Veh/hr)	End queue (Veh)	Delay (s)	LOS
1 - B1145 (E)	215	247	1398	0.154	215	0.2	3.042	A
2 - B1149 (S)	307	165	1424	0.216	308	0.3	3.225	A
3 - B1145 (W)	191	275	1335	0.143	191	0.2	3.148	A
4 - B1149 (N)	209	248	1372	0.153	210	0.2	3.099	A

08:45 - 09:00

Arm	Total Demand (Veh/hr)	Circulating flow (Veh/hr)	Capacity (Veh/hr)	RFC	Throughput (Veh/hr)	End queue (Veh)	Delay (s)	LOS
1 - B1145 (E)	180	207	1424	0.126	180	0.1	2.892	A
2 - B1149 (S)	257	138	1441	0.179	258	0.2	3.044	A
3 - B1145 (W)	160	230	1365	0.117	160	0.1	2.986	A
4 - B1149 (N)	175	208	1397	0.126	176	0.1	2.948	A

2017, PM

Data Errors and Warnings

No errors or warnings

Junction Network

Junctions

Junction	Name	Junction Type	Arm order	Junction Delay (s)	Junction LOS
1	untitled	Standard Roundabout	1, 2, 3, 4	3.29	A

Junction Network Options

Driving side	Lighting
Left	Normal/unknown

Traffic Demand

Demand Set Details

ID	Scenario name	Time Period name	Traffic profile type	Start time (HH:mm)	Finish time (HH:mm)	Time segment length (min)
D2	2017	PM	ONE HOUR	16:15	17:45	15

Vehicle mix source	PCU Factor for a HV (PCU)
HV Percentages	2.00

Demand overview (Traffic)

Arm	Linked arm	Use O-D data	Average Demand (Veh/hr)	Scaling Factor (%)
1 - B1145 (E)		✓	264	100.000
2 - B1149 (S)		✓	345	100.000
3 - B1145 (W)		✓	168	100.000
4 - B1149 (N)		✓	291	100.000

Origin-Destination Data

Demand (Veh/hr)

		To			
		1 - B1145 (E)	2 - B1149 (S)	3 - B1145 (W)	4 - B1149 (N)
From	1 - B1145 (E)	0	75	165	24
	2 - B1149 (S)	65	0	63	217
	3 - B1145 (W)	117	43	0	8
	4 - B1149 (N)	33	244	14	0

Vehicle Mix

Heavy Vehicle Percentages

		To			
		1 - B1145 (E)	2 - B1149 (S)	3 - B1145 (W)	4 - B1149 (N)
From	1 - B1145 (E)	0	1	1	0
	2 - B1149 (S)	2	0	0	3
	3 - B1145 (W)	2	2	0	13
	4 - B1149 (N)	0	4	0	0

Results

Results Summary for whole modelled period

Arm	Max RFC	Max delay (s)	Max Queue (Veh)	Max LOS
1 - B1145 (E)	0.21	3.27	0.3	A
2 - B1149 (S)	0.26	3.33	0.4	A
3 - B1145 (W)	0.14	3.18	0.2	A
4 - B1149 (N)	0.23	3.31	0.3	A

Main Results for each time segment

16:15 - 16:30

Arm	Total Demand (Veh/hr)	Circulating flow (Veh/hr)	Capacity (Veh/hr)	RFC	Throughput (Veh/hr)	End queue (Veh)	Delay (s)	LOS
1 - B1145 (E)	199	226	1461	0.136	198	0.2	2.848	A
2 - B1149 (S)	260	152	1506	0.172	259	0.2	2.884	A
3 - B1145 (W)	126	230	1386	0.091	126	0.1	2.857	A
4 - B1149 (N)	219	169	1457	0.150	218	0.2	2.905	A

16:30 - 16:45

Arm	Total Demand (Veh/hr)	Circulating flow (Veh/hr)	Capacity (Veh/hr)	RFC	Throughput (Veh/hr)	End queue (Veh)	Delay (s)	LOS
1 - B1145 (E)	237	270	1432	0.166	237	0.2	3.013	A
2 - B1149 (S)	310	182	1487	0.209	310	0.3	3.058	A
3 - B1145 (W)	151	275	1357	0.111	151	0.1	2.984	A
4 - B1149 (N)	262	202	1436	0.182	261	0.2	3.065	A

16:45 - 17:00

Arm	Total Demand (Veh/hr)	Circulating flow (Veh/hr)	Capacity (Veh/hr)	RFC	Throughput (Veh/hr)	End queue (Veh)	Delay (s)	LOS
1 - B1145 (E)	291	331	1391	0.209	290	0.3	3.269	A
2 - B1149 (S)	380	223	1460	0.260	380	0.3	3.330	A
3 - B1145 (W)	185	337	1317	0.140	185	0.2	3.178	A
4 - B1149 (N)	320	248	1407	0.228	320	0.3	3.312	A

17:00 - 17:15

Arm	Total Demand (Veh/hr)	Circulating flow (Veh/hr)	Capacity (Veh/hr)	RFC	Throughput (Veh/hr)	End queue (Veh)	Delay (s)	LOS
1 - B1145 (E)	291	331	1391	0.209	291	0.3	3.270	A
2 - B1149 (S)	380	224	1460	0.260	380	0.4	3.331	A
3 - B1145 (W)	185	337	1317	0.140	185	0.2	3.179	A
4 - B1149 (N)	320	248	1407	0.228	320	0.3	3.313	A

17:15 - 17:30

Arm	Total Demand (Veh/hr)	Circulating flow (Veh/hr)	Capacity (Veh/hr)	RFC	Throughput (Veh/hr)	End queue (Veh)	Delay (s)	LOS
1 - B1145 (E)	237	271	1431	0.166	238	0.2	3.018	A
2 - B1149 (S)	310	183	1487	0.209	310	0.3	3.060	A
3 - B1145 (W)	151	275	1357	0.111	151	0.1	2.986	A
4 - B1149 (N)	262	202	1435	0.182	262	0.2	3.067	A

17:30 - 17:45

Arm	Total Demand (Veh/hr)	Circulating flow (Veh/hr)	Capacity (Veh/hr)	RFC	Throughput (Veh/hr)	End queue (Veh)	Delay (s)	LOS
1 - B1145 (E)	199	227	1460	0.136	199	0.2	2.853	A
2 - B1149 (S)	260	153	1506	0.172	260	0.2	2.891	A
3 - B1145 (W)	126	231	1385	0.091	127	0.1	2.861	A
4 - B1149 (N)	219	170	1456	0.150	219	0.2	2.912	A

2022, AM

Data Errors and Warnings

No errors or warnings

Junction Network

Junctions

Junction	Name	Junction Type	Arm order	Junction Delay (s)	Junction LOS
1	untitled	Standard Roundabout	1, 2, 3, 4	3.53	A

Junction Network Options

Driving side	Lighting
Left	Normal/unknown

Traffic Demand

Demand Set Details

ID	Scenario name	Time Period name	Traffic profile type	Start time (HH:mm)	Finish time (HH:mm)	Time segment length (min)
D3	2022	AM	ONE HOUR	07:30	09:00	15

Vehicle mix source	PCU Factor for a HV (PCU)
HV Percentages	2.00

Demand overview (Traffic)

Arm	Linked arm	Use O-D data	Average Demand (Veh/hr)	Scaling Factor (%)
1 - B1145 (E)		✓	260	100.000
2 - B1149 (S)		✓	372	100.000
3 - B1145 (W)		✓	230	100.000
4 - B1149 (N)		✓	253	100.000

Origin-Destination Data

Demand (Veh/hr)

		To			
		1 - B1145 (E)	2 - B1149 (S)	3 - B1145 (W)	4 - B1149 (N)
From	1 - B1145 (E)	0	72	160	28
	2 - B1149 (S)	84	0	68	220
	3 - B1145 (W)	152	64	0	14
	4 - B1149 (N)	18	224	11	0

Vehicle Mix

Heavy Vehicle Percentages

		To			
		1 - B1145 (E)	2 - B1149 (S)	3 - B1145 (W)	4 - B1149 (N)
From	1 - B1145 (E)	0	3	3	15
	2 - B1149 (S)	4	0	6	9
	3 - B1145 (W)	4	3	0	0
	4 - B1149 (N)	18	5	0	0

Results

Results Summary for whole modelled period

Arm	Max RFC	Max delay (s)	Max Queue (Veh)	Max LOS
1 - B1145 (E)	0.21	3.40	0.3	A
2 - B1149 (S)	0.29	3.67	0.4	A
3 - B1145 (W)	0.20	3.53	0.2	A
4 - B1149 (N)	0.21	3.45	0.3	A

Main Results for each time segment

07:30 - 07:45

Arm	Total Demand (Veh/hr)	Circulating flow (Veh/hr)	Capacity (Veh/hr)	RFC	Throughput (Veh/hr)	End queue (Veh)	Delay (s)	LOS
1 - B1145 (E)	196	224	1413	0.138	195	0.2	2.953	A
2 - B1149 (S)	280	149	1434	0.195	279	0.2	3.114	A
3 - B1145 (W)	173	249	1352	0.128	173	0.1	3.050	A
4 - B1149 (N)	190	225	1387	0.137	190	0.2	3.005	A

07:45 - 08:00

Arm	Total Demand (Veh/hr)	Circulating flow (Veh/hr)	Capacity (Veh/hr)	RFC	Throughput (Veh/hr)	End queue (Veh)	Delay (s)	LOS
1 - B1145 (E)	234	269	1385	0.169	234	0.2	3.126	A
2 - B1149 (S)	334	179	1415	0.236	334	0.3	3.330	A
3 - B1145 (W)	207	298	1319	0.157	207	0.2	3.235	A
4 - B1149 (N)	227	269	1359	0.167	227	0.2	3.180	A

08:00 - 08:15

Arm	Total Demand (Veh/hr)	Circulating flow (Veh/hr)	Capacity (Veh/hr)	RFC	Throughput (Veh/hr)	End queue (Veh)	Delay (s)	LOS
1 - B1145 (E)	286	329	1346	0.213	286	0.3	3.396	A
2 - B1149 (S)	410	219	1389	0.295	409	0.4	3.670	A
3 - B1145 (W)	253	365	1274	0.199	253	0.2	3.525	A
4 - B1149 (N)	279	330	1321	0.211	278	0.3	3.453	A

08:15 - 08:30

Arm	Total Demand (Veh/hr)	Circulating flow (Veh/hr)	Capacity (Veh/hr)	RFC	Throughput (Veh/hr)	End queue (Veh)	Delay (s)	LOS
1 - B1145 (E)	286	329	1346	0.213	286	0.3	3.396	A
2 - B1149 (S)	410	219	1389	0.295	410	0.4	3.673	A
3 - B1145 (W)	253	366	1274	0.199	253	0.2	3.526	A
4 - B1149 (N)	279	330	1320	0.211	279	0.3	3.454	A

08:30 - 08:45

Arm	Total Demand (Veh/hr)	Circulating flow (Veh/hr)	Capacity (Veh/hr)	RFC	Throughput (Veh/hr)	End queue (Veh)	Delay (s)	LOS
1 - B1145 (E)	234	269	1385	0.169	234	0.2	3.128	A
2 - B1149 (S)	334	179	1415	0.236	335	0.3	3.336	A
3 - B1145 (W)	207	299	1319	0.157	207	0.2	3.240	A
4 - B1149 (N)	227	270	1359	0.167	228	0.2	3.185	A

08:45 - 09:00

Arm	Total Demand (Veh/hr)	Circulating flow (Veh/hr)	Capacity (Veh/hr)	RFC	Throughput (Veh/hr)	End queue (Veh)	Delay (s)	LOS
1 - B1145 (E)	196	225	1413	0.139	196	0.2	2.960	A
2 - B1149 (S)	280	150	1433	0.195	280	0.2	3.124	A
3 - B1145 (W)	173	250	1351	0.128	173	0.1	3.055	A
4 - B1149 (N)	190	226	1386	0.137	191	0.2	3.012	A

2022, PM

Data Errors and Warnings

No errors or warnings

Junction Network

Junctions

Junction	Name	Junction Type	Arm order	Junction Delay (s)	Junction LOS
1	untitled	Standard Roundabout	1, 2, 3, 4	3.42	A

Junction Network Options

Driving side	Lighting
Left	Normal/unknown

Traffic Demand

Demand Set Details

ID	Scenario name	Time Period name	Traffic profile type	Start time (HH:mm)	Finish time (HH:mm)	Time segment length (min)
D4	2022	PM	ONE HOUR	16:15	17:45	15

Vehicle mix source	PCU Factor for a HV (PCU)
HV Percentages	2.00

Demand overview (Traffic)

Arm	Linked arm	Use O-D data	Average Demand (Veh/hr)	Scaling Factor (%)
1 - B1145 (E)		✓	287	100.000
2 - B1149 (S)		✓	375	100.000
3 - B1145 (W)		✓	183	100.000
4 - B1149 (N)		✓	316	100.000

Origin-Destination Data

Demand (Veh/hr)

		To			
		1 - B1145 (E)	2 - B1149 (S)	3 - B1145 (W)	4 - B1149 (N)
From	1 - B1145 (E)	0	82	179	26
	2 - B1149 (S)	71	0	68	236
	3 - B1145 (W)	127	47	0	9
	4 - B1149 (N)	36	265	15	0

Vehicle Mix

Heavy Vehicle Percentages

		To			
		1 - B1145 (E)	2 - B1149 (S)	3 - B1145 (W)	4 - B1149 (N)
From	1 - B1145 (E)	0	1	1	0
	2 - B1149 (S)	2	0	0	3
	3 - B1145 (W)	2	2	0	13
	4 - B1149 (N)	0	4	0	0

Results

Results Summary for whole modelled period

Arm	Max RFC	Max delay (s)	Max Queue (Veh)	Max LOS
1 - B1145 (E)	0.23	3.41	0.3	A
2 - B1149 (S)	0.29	3.48	0.4	A
3 - B1145 (W)	0.16	3.28	0.2	A
4 - B1149 (N)	0.25	3.44	0.3	A

Main Results for each time segment

16:15 - 16:30

Arm	Total Demand (Veh/hr)	Circulating flow (Veh/hr)	Capacity (Veh/hr)	RFC	Throughput (Veh/hr)	End queue (Veh)	Delay (s)	LOS
1 - B1145 (E)	216	245	1448	0.149	215	0.2	2.918	A
2 - B1149 (S)	282	165	1498	0.188	281	0.2	2.958	A
3 - B1145 (W)	138	250	1373	0.100	137	0.1	2.914	A
4 - B1149 (N)	238	184	1447	0.164	237	0.2	2.973	A

16:30 - 16:45

Arm	Total Demand (Veh/hr)	Circulating flow (Veh/hr)	Capacity (Veh/hr)	RFC	Throughput (Veh/hr)	End queue (Veh)	Delay (s)	LOS
1 - B1145 (E)	258	294	1416	0.182	258	0.2	3.107	A
2 - B1149 (S)	337	198	1477	0.228	337	0.3	3.157	A
3 - B1145 (W)	165	299	1341	0.123	164	0.1	3.058	A
4 - B1149 (N)	284	220	1424	0.199	284	0.2	3.156	A

16:45 - 17:00

Arm	Total Demand (Veh/hr)	Circulating flow (Veh/hr)	Capacity (Veh/hr)	RFC	Throughput (Veh/hr)	End queue (Veh)	Delay (s)	LOS
1 - B1145 (E)	316	360	1373	0.230	316	0.3	3.406	A
2 - B1149 (S)	413	242	1448	0.285	412	0.4	3.473	A
3 - B1145 (W)	201	366	1298	0.155	201	0.2	3.282	A
4 - B1149 (N)	348	270	1393	0.250	348	0.3	3.444	A

17:00 - 17:15

Arm	Total Demand (Veh/hr)	Circulating flow (Veh/hr)	Capacity (Veh/hr)	RFC	Throughput (Veh/hr)	End queue (Veh)	Delay (s)	LOS
1 - B1145 (E)	316	360	1372	0.230	316	0.3	3.407	A
2 - B1149 (S)	413	242	1448	0.285	413	0.4	3.476	A
3 - B1145 (W)	201	367	1298	0.155	201	0.2	3.282	A
4 - B1149 (N)	348	270	1393	0.250	348	0.3	3.444	A

17:15 - 17:30

Arm	Total Demand (Veh/hr)	Circulating flow (Veh/hr)	Capacity (Veh/hr)	RFC	Throughput (Veh/hr)	End queue (Veh)	Delay (s)	LOS
1 - B1145 (E)	258	294	1416	0.182	258	0.2	3.112	A
2 - B1149 (S)	337	198	1477	0.228	338	0.3	3.160	A
3 - B1145 (W)	165	300	1341	0.123	165	0.1	3.060	A
4 - B1149 (N)	284	220	1424	0.199	284	0.3	3.161	A

17:30 - 17:45

Arm	Total Demand (Veh/hr)	Circulating flow (Veh/hr)	Capacity (Veh/hr)	RFC	Throughput (Veh/hr)	End queue (Veh)	Delay (s)	LOS
1 - B1145 (E)	216	246	1448	0.149	216	0.2	2.925	A
2 - B1149 (S)	282	166	1498	0.189	283	0.2	2.962	A
3 - B1145 (W)	138	251	1372	0.100	138	0.1	2.918	A
4 - B1149 (N)	238	185	1447	0.164	238	0.2	2.980	A

2022 + Construction HGVs, AM

Data Errors and Warnings

No errors or warnings

Junction Network

Junctions

Junction	Name	Junction Type	Arm order	Junction Delay (s)	Junction LOS
1	untitled	Standard Roundabout	1, 2, 3, 4	3.68	A

Junction Network Options

Driving side	Lighting
Left	Normal/unknown

Traffic Demand

Demand Set Details

ID	Scenario name	Time Period name	Traffic profile type	Start time (HH:mm)	Finish time (HH:mm)	Time segment length (min)
D5	2022 + Construction HGVs	AM	ONE HOUR	07:30	09:00	15

Vehicle mix source	PCU Factor for a HV (PCU)
HV Percentages	2.00

Demand overview (Traffic)

Arm	Linked arm	Use O-D data	Average Demand (Veh/hr)	Scaling Factor (%)
1 - B1145 (E)		✓	260	100.000
2 - B1149 (S)		✓	398	100.000
3 - B1145 (W)		✓	248	100.000
4 - B1149 (N)		✓	274	100.000

Origin-Destination Data

Demand (Veh/hr)

		To			
		1 - B1145 (E)	2 - B1149 (S)	3 - B1145 (W)	4 - B1149 (N)
From	1 - B1145 (E)	0	72	160	28
	2 - B1149 (S)	84	0	79	235
	3 - B1145 (W)	152	75	0	21
	4 - B1149 (N)	18	239	17	0

Vehicle Mix

Heavy Vehicle Percentages

		To			
		1 - B1145 (E)	2 - B1149 (S)	3 - B1145 (W)	4 - B1149 (N)
From	1 - B1145 (E)	0	3	3	15
	2 - B1149 (S)	4	0	5	9
	3 - B1145 (W)	4	3	0	0
	4 - B1149 (N)	18	5	54	0

Results

Results Summary for whole modelled period

Arm	Max RFC	Max delay (s)	Max Queue (Veh)	Max LOS
1 - B1145 (E)	0.22	3.49	0.3	A
2 - B1149 (S)	0.32	3.82	0.5	A
3 - B1145 (W)	0.22	3.63	0.3	A
4 - B1149 (N)	0.24	3.70	0.3	A

Main Results for each time segment

07:30 - 07:45

Arm	Total Demand (Veh/hr)	Circulating flow (Veh/hr)	Capacity (Veh/hr)	RFC	Throughput (Veh/hr)	End queue (Veh)	Delay (s)	LOS
1 - B1145 (E)	196	248	1394	0.140	195	0.2	3.001	A
2 - B1149 (S)	300	154	1429	0.210	299	0.3	3.181	A
3 - B1145 (W)	187	260	1346	0.139	186	0.2	3.102	A
4 - B1149 (N)	206	233	1341	0.154	206	0.2	3.168	A

07:45 - 08:00

Arm	Total Demand (Veh/hr)	Circulating flow (Veh/hr)	Capacity (Veh/hr)	RFC	Throughput (Veh/hr)	End queue (Veh)	Delay (s)	LOS
1 - B1145 (E)	234	297	1361	0.172	234	0.2	3.191	A
2 - B1149 (S)	358	184	1409	0.254	357	0.3	3.423	A
3 - B1145 (W)	223	312	1311	0.170	223	0.2	3.306	A
4 - B1149 (N)	246	279	1313	0.188	246	0.2	3.373	A

08:00 - 08:15

Arm	Total Demand (Veh/hr)	Circulating flow (Veh/hr)	Capacity (Veh/hr)	RFC	Throughput (Veh/hr)	End queue (Veh)	Delay (s)	LOS
1 - B1145 (E)	286	364	1317	0.217	286	0.3	3.490	A
2 - B1149 (S)	438	225	1381	0.317	438	0.5	3.812	A
3 - B1145 (W)	273	382	1264	0.216	273	0.3	3.630	A
4 - B1149 (N)	302	342	1275	0.237	301	0.3	3.699	A

08:15 - 08:30

Arm	Total Demand (Veh/hr)	Circulating flow (Veh/hr)	Capacity (Veh/hr)	RFC	Throughput (Veh/hr)	End queue (Veh)	Delay (s)	LOS
1 - B1145 (E)	286	364	1317	0.217	286	0.3	3.491	A
2 - B1149 (S)	438	226	1381	0.317	438	0.5	3.816	A
3 - B1145 (W)	273	382	1264	0.216	273	0.3	3.631	A
4 - B1149 (N)	302	342	1274	0.237	302	0.3	3.699	A

08:30 - 08:45

Arm	Total Demand (Veh/hr)	Circulating flow (Veh/hr)	Capacity (Veh/hr)	RFC	Throughput (Veh/hr)	End queue (Veh)	Delay (s)	LOS
1 - B1145 (E)	234	298	1361	0.172	234	0.2	3.194	A
2 - B1149 (S)	358	185	1409	0.254	358	0.3	3.430	A
3 - B1145 (W)	223	312	1311	0.170	223	0.2	3.312	A
4 - B1149 (N)	246	280	1313	0.188	247	0.2	3.376	A

08:45 - 09:00

Arm	Total Demand (Veh/hr)	Circulating flow (Veh/hr)	Capacity (Veh/hr)	RFC	Throughput (Veh/hr)	End queue (Veh)	Delay (s)	LOS
1 - B1145 (E)	196	249	1393	0.141	196	0.2	3.006	A
2 - B1149 (S)	300	154	1429	0.210	300	0.3	3.191	A
3 - B1145 (W)	187	262	1345	0.139	187	0.2	3.107	A
4 - B1149 (N)	206	234	1341	0.154	206	0.2	3.173	A

2022 + Construction HGVs, PM

Data Errors and Warnings

No errors or warnings

Junction Network

Junctions

Junction	Name	Junction Type	Arm order	Junction Delay (s)	Junction LOS
1	untitled	Standard Roundabout	1, 2, 3, 4	3.80	A

Junction Network Options

Driving side	Lighting
Left	Normal/unknown

Traffic Demand

Demand Set Details

ID	Scenario name	Time Period name	Traffic profile type	Start time (HH:mm)	Finish time (HH:mm)	Time segment length (min)
D6	2022 + Construction HGVs	PM	ONE HOUR	16:15	17:45	15

Vehicle mix source	PCU Factor for a HV (PCU)
HV Percentages	2.00

Demand overview (Traffic)

Arm	Linked arm	Use O-D data	Average Demand (Veh/hr)	Scaling Factor (%)
1 - B1145 (E)		✓	287	100.000
2 - B1149 (S)		✓	381	100.000
3 - B1145 (W)		✓	217	100.000
4 - B1149 (N)		✓	340	100.000

Origin-Destination Data

Demand (Veh/hr)

		To			
		1 - B1145 (E)	2 - B1149 (S)	3 - B1145 (W)	4 - B1149 (N)
From	1 - B1145 (E)	0	82	179	26
	2 - B1149 (S)	71	0	68	242
	3 - B1145 (W)	127	68	0	22
	4 - B1149 (N)	36	289	15	0

Vehicle Mix

Heavy Vehicle Percentages

		To			
		1 - B1145 (E)	2 - B1149 (S)	3 - B1145 (W)	4 - B1149 (N)
From	1 - B1145 (E)	0	1	1	0
	2 - B1149 (S)	2	0	14	9
	3 - B1145 (W)	2	21	0	50
	4 - B1149 (N)	0	9	30	0

Results

Results Summary for whole modelled period

Arm	Max RFC	Max delay (s)	Max Queue (Veh)	Max LOS
1 - B1145 (E)	0.24	3.59	0.3	A
2 - B1149 (S)	0.31	3.82	0.4	A
3 - B1145 (W)	0.20	3.88	0.3	A
4 - B1149 (N)	0.29	3.89	0.4	A

Main Results for each time segment

16:15 - 16:30

Arm	Total Demand (Veh/hr)	Circulating flow (Veh/hr)	Capacity (Veh/hr)	RFC	Throughput (Veh/hr)	End queue (Veh)	Delay (s)	LOS
1 - B1145 (E)	216	279	1411	0.153	215	0.2	3.010	A
2 - B1149 (S)	287	165	1409	0.204	286	0.3	3.202	A
3 - B1145 (W)	163	254	1239	0.132	163	0.2	3.343	A
4 - B1149 (N)	256	200	1357	0.189	255	0.2	3.262	A

16:30 - 16:45

Arm	Total Demand (Veh/hr)	Circulating flow (Veh/hr)	Capacity (Veh/hr)	RFC	Throughput (Veh/hr)	End queue (Veh)	Delay (s)	LOS
1 - B1145 (E)	258	334	1371	0.188	258	0.2	3.233	A
2 - B1149 (S)	343	198	1389	0.247	342	0.3	3.440	A
3 - B1145 (W)	195	305	1208	0.161	195	0.2	3.551	A
4 - B1149 (N)	306	239	1333	0.229	305	0.3	3.504	A

16:45 - 17:00

Arm	Total Demand (Veh/hr)	Circulating flow (Veh/hr)	Capacity (Veh/hr)	RFC	Throughput (Veh/hr)	End queue (Veh)	Delay (s)	LOS
1 - B1145 (E)	316	409	1318	0.240	316	0.3	3.593	A
2 - B1149 (S)	419	242	1361	0.308	419	0.4	3.819	A
3 - B1145 (W)	239	373	1167	0.205	239	0.3	3.877	A
4 - B1149 (N)	374	293	1299	0.288	374	0.4	3.891	A

17:00 - 17:15

Arm	Total Demand (Veh/hr)	Circulating flow (Veh/hr)	Capacity (Veh/hr)	RFC	Throughput (Veh/hr)	End queue (Veh)	Delay (s)	LOS
1 - B1145 (E)	316	410	1317	0.240	316	0.3	3.594	A
2 - B1149 (S)	419	242	1361	0.308	419	0.4	3.823	A
3 - B1145 (W)	239	373	1167	0.205	239	0.3	3.880	A
4 - B1149 (N)	374	293	1299	0.288	374	0.4	3.895	A

17:15 - 17:30

Arm	Total Demand (Veh/hr)	Circulating flow (Veh/hr)	Capacity (Veh/hr)	RFC	Throughput (Veh/hr)	End queue (Veh)	Delay (s)	LOS
1 - B1145 (E)	258	335	1371	0.188	258	0.2	3.239	A
2 - B1149 (S)	343	198	1388	0.247	343	0.3	3.444	A
3 - B1145 (W)	195	305	1208	0.161	195	0.2	3.557	A
4 - B1149 (N)	306	239	1332	0.229	306	0.3	3.511	A

17:30 - 17:45

Arm	Total Demand (Veh/hr)	Circulating flow (Veh/hr)	Capacity (Veh/hr)	RFC	Throughput (Veh/hr)	End queue (Veh)	Delay (s)	LOS
1 - B1145 (E)	216	280	1410	0.153	216	0.2	3.018	A
2 - B1149 (S)	287	166	1408	0.204	287	0.3	3.213	A
3 - B1145 (W)	163	255	1238	0.132	164	0.2	3.352	A
4 - B1149 (N)	256	200	1357	0.189	256	0.2	3.273	A

Appendix G Index of Changes

Title	Description of Change/Insertion Sheet Title	PDF Page Number of Change	PDF Page Number of missing data	Explanation for inclusion in this version
Table 1.2: Existing Daily Traffic Flows	Correction of Table 1.2: Existing Daily Traffic Flows. Link 77 corrected to read Link 78	19	n/a	Typographical correction.
Table 1.6: Daily Construction Vehicle Movements	Correction of Table 1.6: Daily Construction Vehicle Movements. Link 77 corrected to read Link 78	33	n/a	Typographical correction.
Table 1.7: Percentage Impact of Construction Traffic - Sensitivity Testing	Correction of Table 1.7: Percentage Impact of Construction Traffic - Sensitivity Testing. Link 77 corrected to read Link 78	34	n/a	Typographical correction.
Hourly Construction HGV Flows ^a	Hourly Construction HGV Flows	54 - 87	n/a	Not included in Version 1 of the Transport Assessment as submitted due to a clerical error.
Hourly Construction HGV Flows Sensitivity Scenario ^a	Hourly Construction HGV Flows Sensitivity Scenario	88 - 121	n/a	
Network and Construction Peak Comparisons ^b	Northern Group + Landfall + Booster Station + Substation Hourly HGVS	265	260	Data was not included in the existing diagrams at Appendix C of Version 1 of the Transport Assessment as submitted due to a clerical error. It was agreed with Highways England to assess a junction on the trunk road network if construction traffic flows through a junction exceeded 30 vehicle movements during the network peak hour. The maximum scenario and maximum sensitivity scenario assess the maximum number of vehicle movements going through all turning manoeuvres of a junction at any one time. In Version 1 of the Transport Assessment as submitted, this would not have been representative as this takes into account multiple groups being constructed simultaneously. Therefore, in Version 2 of the Transport Assessment (this version), we have disaggregated these into the individual groups, showing that the 30 movements per hour threshold is not exceeded.
	Middle (northern) Group + Landfall + Booster Station + Substation Hourly HGVS	266		
	Middle (southern) Group + Landfall + Booster Station + Substation Hourly HGVS	267		
	Southern Group + Landfall + Booster Station + Substation Hourly HGVS	268		
	Northern Group + Landfall + Booster Station + Substation Hourly HGVS (Sensitivity Scenario)	269	264	
	Middle (northern) Group + Landfall + Booster Station + Substation Hourly HGVS (Sensitivity Scenario)	270		
	Middle (southern) Group + Landfall + Booster Station + Substation Hourly HGVS (Sensitivity Scenario)	271		
	Southern Group + Landfall + Booster Station + Substation Hourly HGVS (Sensitivity Scenario)	272		

Base Flows ^a	2022 06:00-07:00 Weekday Traffic Flows	273	n/a	It was also agreed with Highways England that if the construction staff traffic flows added to the baseline traffic flows subsequently exceed the network peak hour, then an assessment of the impact upon highway capacity of that junction would be undertaken. Therefore, in Version 2 of the Transport Assessment (this version), we have shown the baseline traffic flows during the construction staff movement periods and the peak hours to demonstrate the peak hour flows are not exceeded.
	2022 07:00-08:00 Weekday Traffic Flows	274	n/a	
	2022 08:00-09:00 Weekday Traffic Flows	275	n/a	
	2022 17:00-18:00 Weekday Traffic Flows	276	n/a	
	2022 18:00-19:00 Weekday Traffic Flows	277	n/a	
^a Inserted appendix documents – not included in Version 1 of the Transport Assessment as submitted. ^b Inserted page which replaces part of an existing page in Version 1 of the Transport Assessment as submitted.				