



# The Sizewell C Project

## 6.5 Volume 4 Southern Park and Ride Chapter 2 Description of the Southern Park and Ride Appendix 2A Proposed Development Drawings

---

Revision: 1.0  
Applicable Regulation: Regulation 5(2)(a)  
PINS Reference Number: EN010012

---

May 2020

Planning Act 2008  
Infrastructure Planning (Applications: Prescribed  
Forms and Procedure) Regulations 2009



## APPENDIX 2A – SOUTHERN PARK AND RIDE PROPOSED DEVELOPMENT DRAWINGS

### LIST OF CONTENTS

#### Plans from the Book of Plans – Book 2

Drawing title	DCO Drawing number	Doc. Ref.
<b>Works Plans</b>		
Southern Park and Ride Works Plan Sheet of 16 of 27	SZC-SZ0204-XX-000-DRW-100251	2.3
<b>Highway layout plans, profiles and general arrangements</b>		
Southern Park and Ride Proposed General Arrangement	SZC-SZ0204-FP-000-DRW-100009	2.7
Southern Park and Ride Highway Proposed General Arrangement Key Plan	SZC-SZ0204-XX-000-DRW-100525	2.7
Southern Park and Ride Highway Proposed General Arrangement Sheet 1 of 3	SZC-SZ0204-XX-000-DRW-100526	2.7
Southern Park and Ride Highway Proposed General Arrangement Sheet 2 of 3	SZC-SZ0204-XX-000-DRW-100527	2.7
Southern Park and Ride Highway Proposed General Arrangement Sheet 3 of 3	SZC-SZ0204-XX-000-DRW-100528	2.7
<b>Cross-sections</b>		
Southern Park and Ride Existing and Proposed Cross Sections Sheet 1 of 4	SZC-SZ0204-FP-000-DRW-100082	2.7
Southern Park and Ride Existing and Proposed Cross Sections Sheet 2 of 4	SZC-SZ0204-FP-000-DRW-100083	2.7
Southern Park and Ride Existing and Proposed Cross Sections Sheet 3 of 4	SZC-SZ0204-FP-000-DRW-100084	2.7
Southern Park and Ride Existing and Proposed Cross Sections Sheet 4 of 4	SZC-SZ0204-FP-000-DRW-100085	2.7
<b>Rights of way plans</b>		
Southern Park and Ride Rights of Way Plan Sheet 16 of 27	SZC-SZ0204-XX-000-DRW-100335	2.4

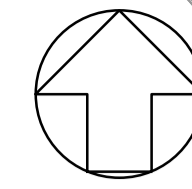

**NOTES:**

1. THE ORDNANCE SURVEY MASTERMAP DATA ADOPTED AS DRAWING BACKGROUND TOPOGRAPHY DATA.

**KEY:**

- ORDER LIMITS
- WORK No. 10
- A\*/A (A) NEW OR ALTERED POINT OF ACCESS

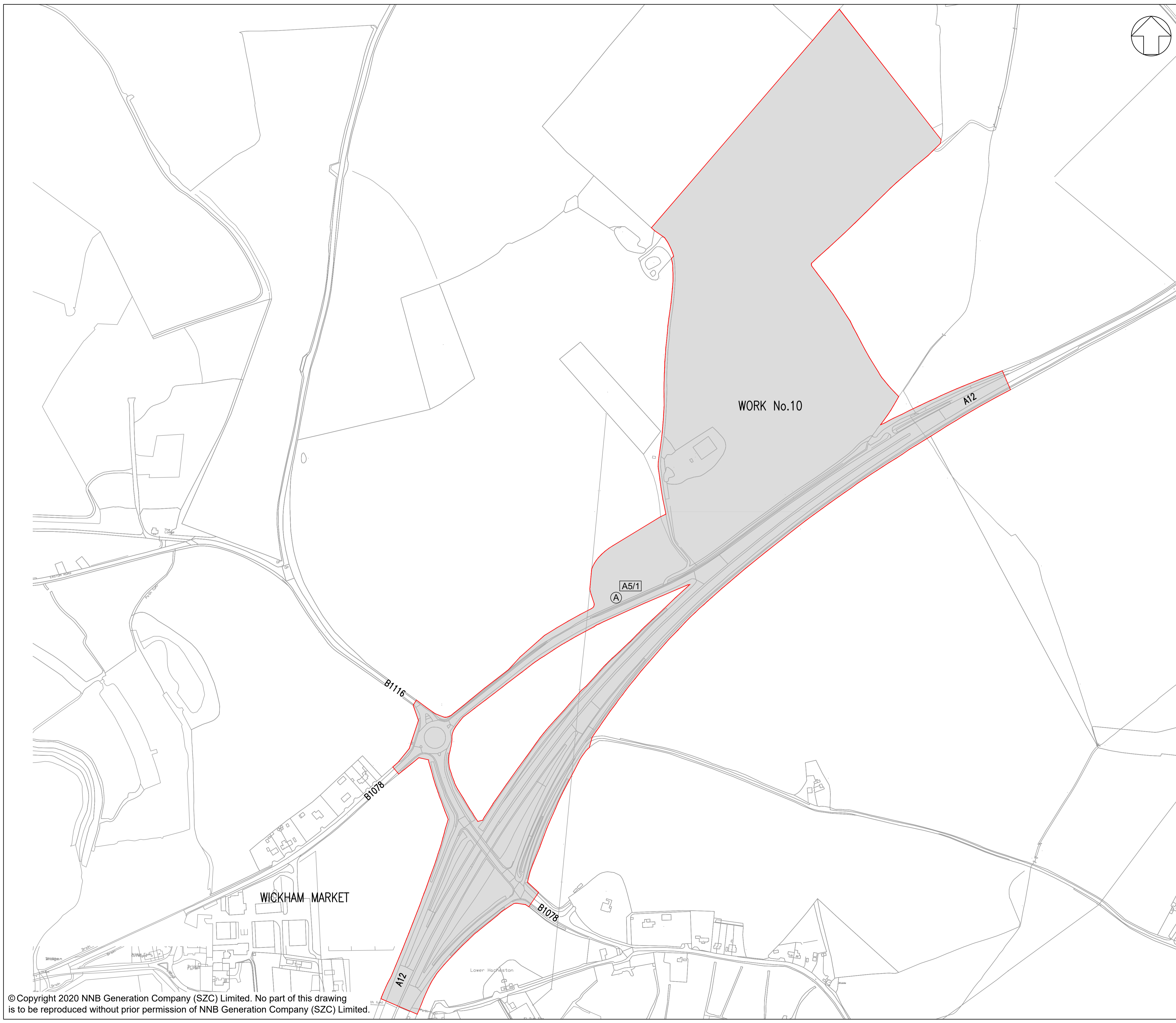

01	01/02/2020	LMM	HP	DCO SUBMISSION	SZC Co
REVISION	DATE	DRAWN/CHECKED	REASONS FOR REVISION / COMMENTS		APPROVED

NOT PROTECTIVELY MARKED

**COPYRIGHT:**  
 Reproduced from Ordnance Survey map with the permission of Ordnance Survey on behalf of the controller of Her Majesty's Stationery Office © Crown copyright (2019). All Rights reserved. NNB GenCo Licence: 0100060408



**PROJECT:**  
 SIZEWELL C

**DOCUMENT:**  
 WORKS PLANS  
 REGULATION 5(2)(j)

**DRAWING TITLE:**  
 SOUTHERN PARK AND RIDE  
 WORKS PLANS - SHEET 16 OF 27

DRAWING NO:	REVISION:
SZC-SZ0204-XX-000-DRW-100251	01

DATE:	DRAWN:	SCALE:
FEB 2020	LMM	1:2500 @ A1

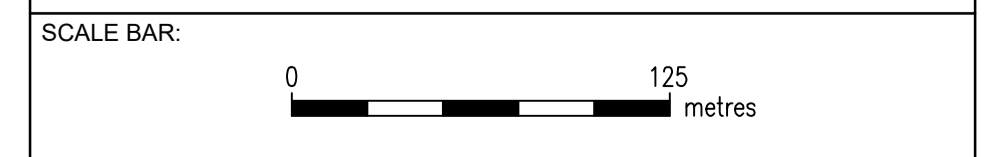

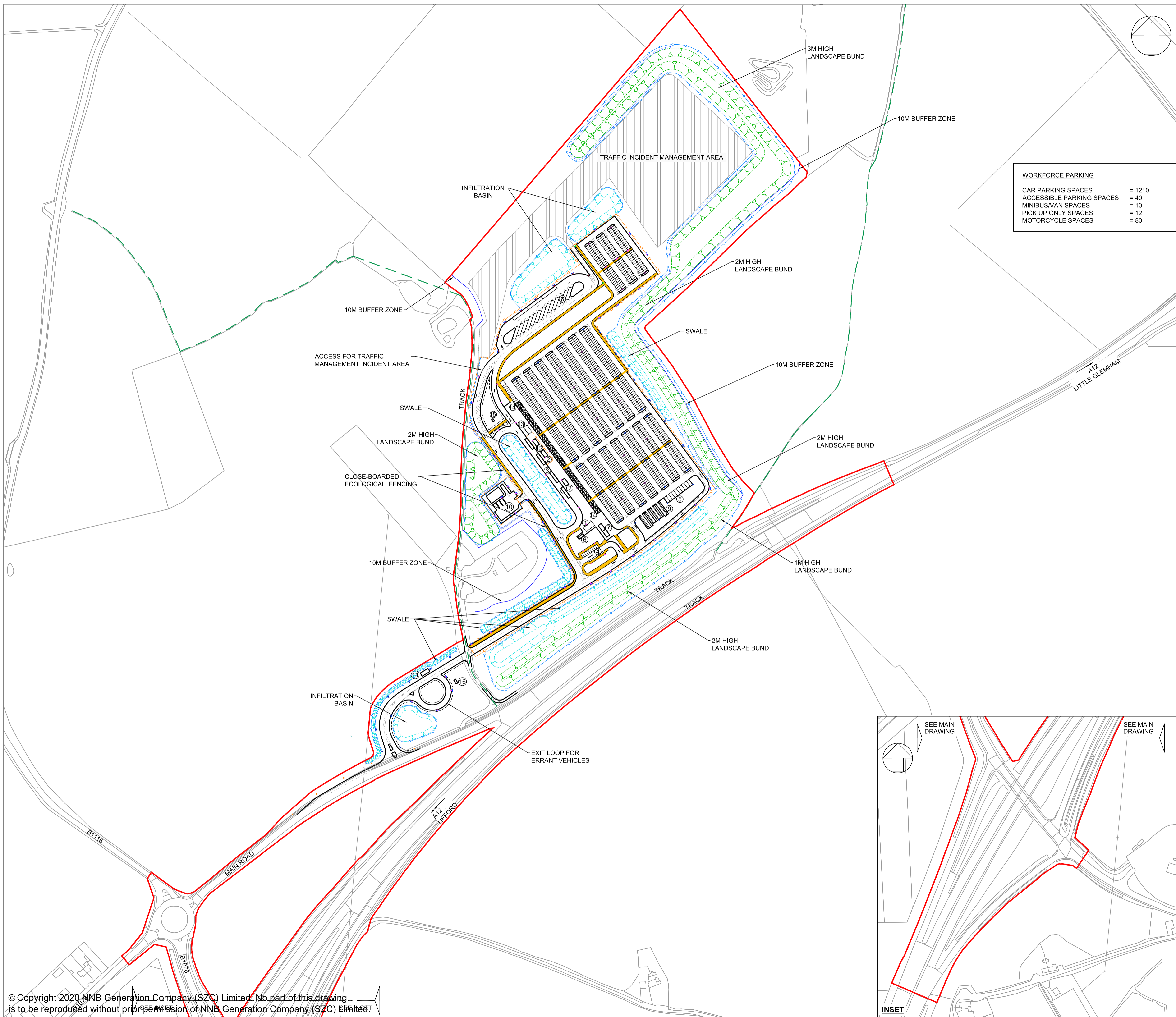

WORKFORCE PARKING	
CAR PARKING SPACES	= 1210
ACCESSIBLE PARKING SPACES	= 40
MINIBUS/VAN SPACES	= 10
PICK UP ONLY SPACES	= 12
MOTORCYCLE SPACES	= 80

**NOTES:**  
 1. Do not scale from this drawing. All dimensions are in metres unless noted otherwise.  
 2. For Lighting Column specifications see drawings SZC-SZ0204-FP-000-DRW-100011-13, 100054 and 100099.

- KEY:**
- DEVELOPMENT SITE BOUNDARY
  - ① AMENITY AND WELFARE BUILDING
  - ② BUS SHELTERS
  - ③ BUS STOPS
  - ④ DROP OFF
  - ⑤ VAN / MINIBUS PARKING
  - ⑥ SMOKING SHELTER
  - ⑦ CYCLE SHELTER
  - ⑧ OVERNIGHT BUS PARKING
  - ⑨ MOTORCYCLE PARKING
  - ⑩ POSTAL CONSOLIDATION BUILDING
  - ⑪ SECURITY BOOTH
  - ⑫ SECURE BUS TERMINAL
  - ⑬ SECURITY BUILDING
  - ⑭ ACCESSIBLE PARKING
  - ⑮ PACKAGE TREATMENT PLANT
  - ⑯ SEPTIC TANK
  - BUFFER ZONE
  - SECURITY FENCE (1.8M HIGH)
  - ECOLOGICAL FENCING
  - GATE
  - SWALE / INFILTRATION BASIN (INDICATIVE)
  - LANDSCAPE BUND
  - PEDESTRIAN WALKWAY
  - MANUAL RISING ARM BARRIER
  - EXISTING PUBLIC RIGHT OF WAY
  - PROPOSED DITCH (INDICATIVE)
  - PROPOSED LIGHTING COLUMNS(INDICATIVE)
  - LIGHTING LANTERN DEMOUNTABLE SHIELD

REVISION	DATE	DRAWN	CHECKED	REASONS FOR REVISION / COMMENTS	APPROVED
01	FEB 2020	NKS	KA	DCO SUBMISSION	PJ

**NOT PROTECTIVELY MARKED**

**COPYRIGHT:**  
 Reproduced from Ordnance Survey map with the permission of Ordnance Survey on behalf of the controller of Her Majesty's Stationery Office © Crown copyright (2019). All Rights reserved. NNB GenCo Licence: 0100060408



**PROJECT:**  
 SIZEWELL C

**DOCUMENT:**  
 APPLICATION DRAWING - FOR APPROVAL REGULATION 5(2)(c)

**DRAWING TITLE:**  
 SOUTHERN PARK AND RIDE PROPOSED GENERAL ARRANGEMENT

<b>DRAWING NO:</b> SZC-SZ0204-FP-000-DRW-100009	<b>REVISION:</b> 01
<b>DATE:</b> FEB 2020	<b>DRAWN:</b> NKS
<b>SCALE:</b> 1:2000@A1	

SCALE BAR: 0m 40m 80m 120m  
 SCALE IN METRES 1:2000

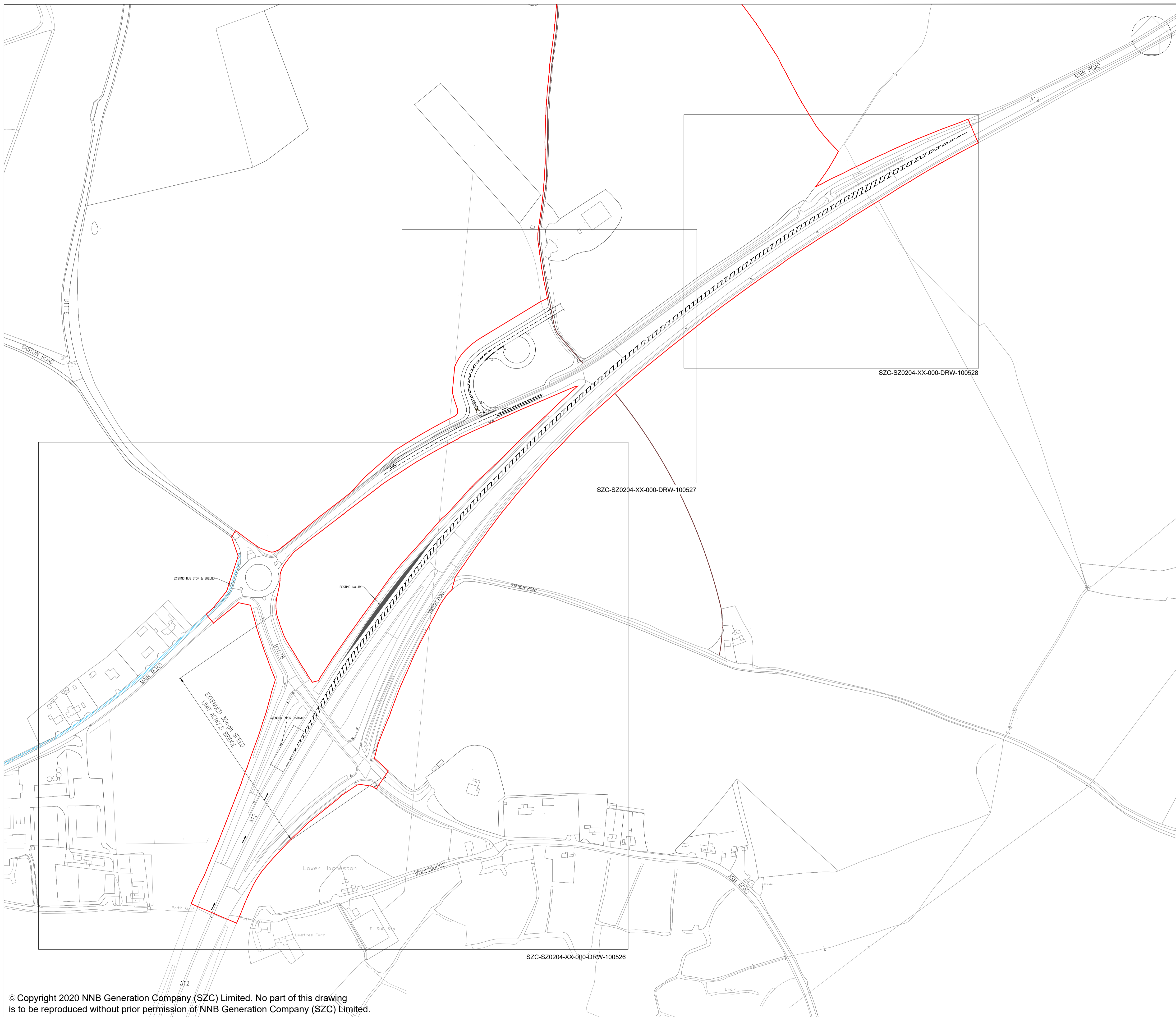

- NOTES
1. THIS DRAWING IS FOR PLANNING PURPOSES ONLY AND SHALL NOT BE USED FOR CONSTRUCTION OR ANY OTHER PURPOSE.
  2. THE SCHEME DESIGN IS BASED ON ORDNANCE SURVEY MAPPING DATA. THE EXISTING GROUND TERRAIN AND PROPOSED SURFACES ARE BASED ON THE UK GOVERNMENT'S OPEN SOURCE LIDAR DIGITAL TERRAIN MAPPING DATA. ALL POSITIONS AND LEVELS ARE TO BE REVIEWED FOLLOWING COMPLETION OF A DETAILED SITE TOPOGRAPHICAL SURVEY.
  3. NEW SIGNS AND ROAD MARKINGS WILL BE BASED ON TSRGD 2016 OR AS AGREED WITH THE LOCAL HIGHWAY AUTHORITY.
  4. ALL DIMENSIONS IN METRES UNLESS STATED OTHERWISE.
  5. FOR DETAILS OF LANDSCAPING AND PLANTING REFER TO THE LANDSCAPE ARCHITECTS PLANS.
  6. ALL PROPOSED ROADWORKS ARE TO BE IN ACCORDANCE WITH THE DESIGN MANUAL FOR ROADS AND BRIDGES (DMRB OR AS AGREED WITH LOCAL AUTHORITY).
  7. WHERE PROPOSED ROAD MARKINGS ARE SHOWN THE EXISTING ROAD MARKINGS ARE TO BE REMOVED AS APPROPRIATE.

KEY:

— DEVELOPMENT SITE BOUNDARY

REVISION	DATE	DRAWN/CHECKED	REASONS FOR REVISION / COMMENTS	APPROVED	SZC Co
01	FEB 2020	DHP	HWP	DCO SUBMISSION	

**NOT PROTECTIVELY MARKED**

**COPYRIGHT:**  
 Reproduced from Ordnance Survey map with the permission of Ordnance Survey on behalf of the controller of Her Majesty's Stationery Office © Crown copyright (2019). All Rights reserved. NNB GenCo Licence: 0100060408



PROJECT:  
**SIZEWELL C**

DOCUMENT:  
**APPLICATION DRAWING - FOR APPROVAL REGULATION 5(2)(c)**

DRAWING TITLE:  
**SOUTHERN PARK AND RIDE HIGHWAY PROPOSED GENERAL ARRANGEMENT KEY PLAN**

DRAWING NO:  
**SZC-SZ0204-XX-000-DRW-100525**

REVISION:  
**01**

DATE:  
**FEB 2020**

DRAWN:  
**DHP**

SCALE:  
**1:2000 @ A1**

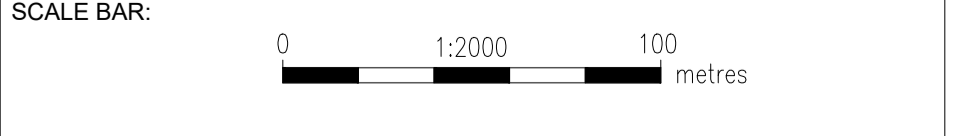

See Drawing No: SCZ-SZ0204-XX-000-DRW-100527

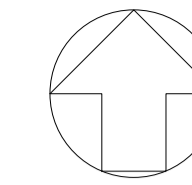

NOTES

1. THIS DRAWING IS FOR PLANNING PURPOSES ONLY AND SHALL NOT BE USED FOR CONSTRUCTION OR ANY OTHER PURPOSE.
2. THE SCHEME DESIGN IS BASED ON ORDNANCE SURVEY MAPPING DATA. THE EXISTING GROUND TERRAIN AND PROPOSED SURFACES ARE BASED ON THE UK GOVERNMENT'S OPEN SOURCE LIDAR DIGITAL TERRAIN MAPPING DATA. ALL POSITIONS AND LEVELS ARE TO BE REVIEWED FOLLOWING COMPLETION OF A DETAILED SITE TOPOGRAPHICAL SURVEY.
3. NEW SIGNS AND ROAD MARKINGS WILL BE BASED ON TSRGD 2016 OR AS AGREED WITH THE LOCAL HIGHWAY AUTHORITY.
4. ALL DIMENSIONS IN METRES UNLESS STATED OTHERWISE.
5. FOR DETAILS OF LANDSCAPING AND PLANTING REFER TO THE LANDSCAPE ARCHITECTS PLANS.
6. ALL PROPOSED ROADWORKS ARE TO BE IN ACCORDANCE WITH THE DESIGN MANUAL FOR ROADS AND BRIDGES (DMRB) OR AS AGREED WITH LOCAL AUTHORITY.
7. WHERE PROPOSED ROAD MARKINGS ARE SHOWN THE EXISTING ROAD MARKINGS ARE TO BE REMOVED AS APPROPRIATE.

KEY:

- DEVELOPMENT SITE BOUNDARY
- EXISTING LAY BY
- PROPOSED ROAD MARKING



01	FEB 2020	DHP	HWP	DCO SUBMISSION	SZC Co
REVISION	DATE	DRAWN/CHECKED	REASONS FOR REVISION / COMMENTS		APPROVED

NOT PROTECTIVELY MARKED

COPYRIGHT:

Reproduced from Ordnance Survey map with the permission of Ordnance Survey on behalf of the controller of Her Majesty's Stationery Office © Crown copyright (2019). All Rights reserved. NNB GenCo Licence: 0100060408



PROJECT:  
SIZEWELL C

DOCUMENT:  
APPLICATION DRAWING -  
FOR APPROVAL  
REGULATION 5(2)(c)

DRAWING TITLE:  
SOUTHERN PARK AND RIDE  
HIGHWAY PROPOSED GENERAL  
ARRANGEMENT  
SHEET 1 OF 3

DRAWING NO: SZC-SZ0204-XX-000-DRW-100526 REVISION: 01

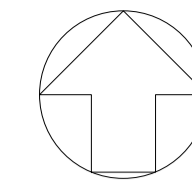

DATE: FEB 2020 DRAWN: DHP SCALE: 1:500 @ A1

SCALE BAR: 0 1:500 25 metres



- NOTES
1. THIS DRAWING IS FOR PLANNING PURPOSES ONLY AND SHALL NOT BE USED FOR CONSTRUCTION OR ANY OTHER PURPOSE.
  2. THE SCHEME DESIGN IS BASED ON ORDNANCE SURVEY MAPPING DATA. THE EXISTING GROUND TERRAIN AND PROPOSED SURFACES ARE BASED ON THE UK GOVERNMENT'S OPEN SOURCE LIDAR DIGITAL TERRAIN MAPPING DATA. ALL POSITIONS AND LEVELS ARE TO BE REVIEWED FOLLOWING COMPLETION OF A DETAILED SITE TOPOGRAPHICAL SURVEY.
  3. NEW SIGNS AND ROAD MARKINGS WILL BE BASED ON TSRGD 2016 OR AS AGREED WITH THE LOCAL HIGHWAY AUTHORITY.
  4. ALL DIMENSIONS IN METRES UNLESS STATED OTHERWISE.
  5. FOR DETAILS OF LANDSCAPING AND PLANTING REFER TO THE LANDSCAPE ARCHITECTS PLANS.
  6. ALL PROPOSED ROADWORKS ARE TO BE IN ACCORDANCE WITH THE DESIGN MANUAL FOR ROADS AND BRIDGES (DMRB OR AS AGREED WITH LOCAL AUTHORITY).
  7. WHERE PROPOSED ROAD MARKINGS ARE SHOWN THE EXISTING ROAD MARKINGS ARE TO BE REMOVED AS APPROPRIATE.

KEY:

-  DEVELOPMENT SITE BOUNDARY
-  EXISTING LAY BY
-  PROPOSED ROAD MARKING

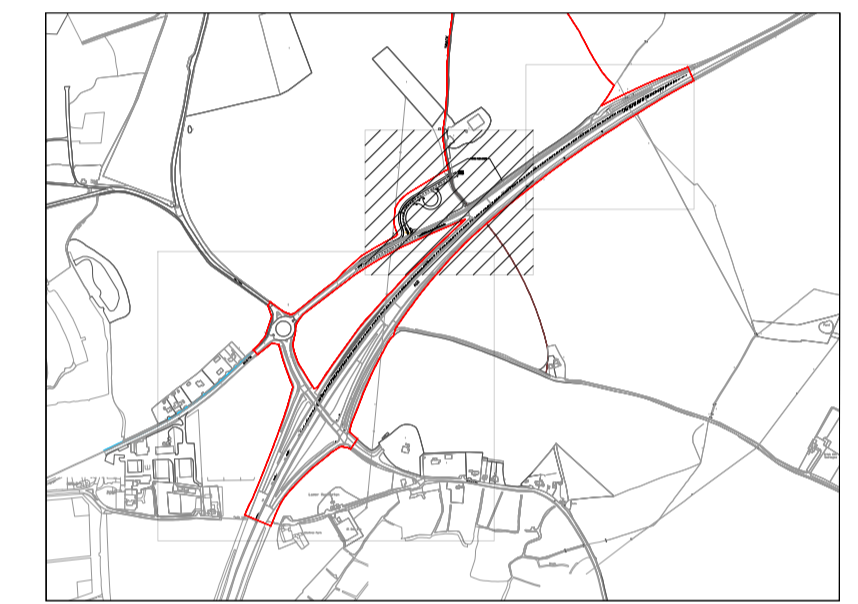

REVISION	DATE	DRAWN/CHECKED	REASONS FOR REVISION / COMMENTS	APPROVED	
01	FEB 2020	DHP	HWP	DCO SUBMISSION	SZC Co

NOT PROTECTIVELY MARKED

**COPYRIGHT:**  
 Reproduced from Ordnance Survey map with the permission of Ordnance Survey on behalf of the controller of Her Majesty's Stationery Office © Crown copyright (2019). All Rights reserved. NNB GenCo Licence: 0100060408



PROJECT:  
 SIZEWELL C

DOCUMENT:  
 APPLICATION DRAWING -  
 FOR APPROVAL  
 REGULATION 5(2)(o)

DRAWING TITLE:  
 SOUTHERN PARK AND RIDE  
 HIGHWAY PROPOSED GENERAL  
 ARRANGEMENT  
 SHEET 2 OF 3

DRAWING NO:  
 SZC-SZ0204-XX-000-DRW-10527

REVISION:  
 01

DATE: FEB 2020

DRAWN: DHP

SCALE: 1:500 @ A1

SCALE BAR:  

See Drawing No: SZC-SZ0204-XX-000-DRW-100526



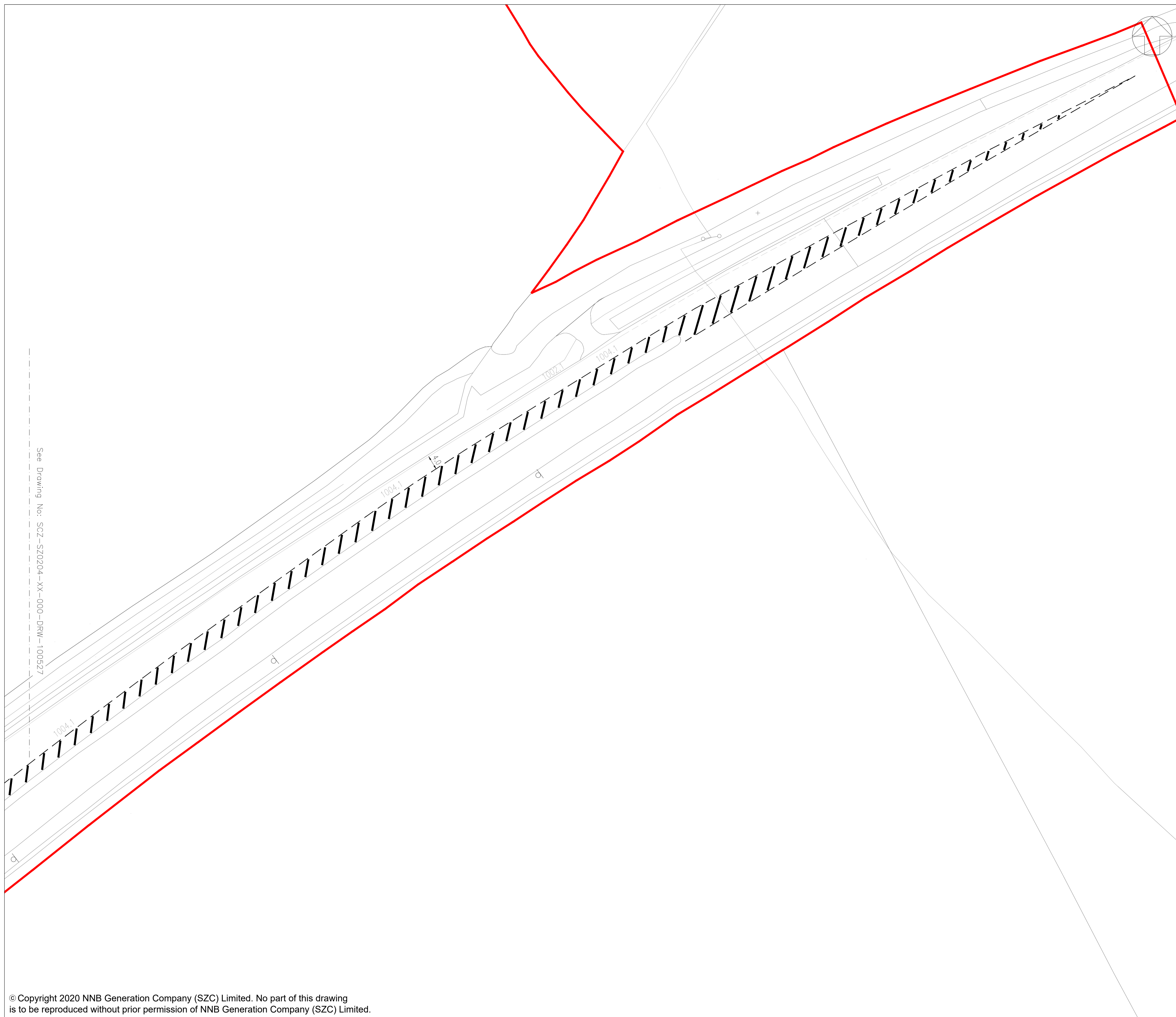

See Drawing No: SZC-SZ0204-XX-000-DRW-100527

- NOTES**
1. THIS DRAWING IS FOR PLANNING PURPOSES ONLY AND SHALL NOT BE USED FOR CONSTRUCTION OR ANY OTHER PURPOSE.
  2. THE SCHEME DESIGN IS BASED ON ORDNANCE SURVEY MAPPING DATA. THE EXISTING GROUND TERRAIN AND PROPOSED SURFACES ARE BASED ON THE UK GOVERNMENT'S OPEN SOURCE LIDAR DIGITAL TERRAIN MAPPING DATA. ALL POSITIONS AND LEVELS ARE TO BE REVIEWED FOLLOWING COMPLETION OF A DETAILED SITE TOPOGRAPHICAL SURVEY.
  3. NEW SIGNS AND ROAD MARKINGS WILL BE BASED ON TSRGD 2016 OR AS AGREED WITH THE LOCAL HIGHWAY AUTHORITY.
  4. ALL DIMENSIONS IN METRES UNLESS STATED OTHERWISE.
  5. FOR DETAILS OF LANDSCAPING AND PLANTING REFER TO THE LANDSCAPE ARCHITECTS PLANS.
  6. ALL PROPOSED ROADWORKS ARE TO BE IN ACCORDANCE WITH THE DESIGN MANUAL FOR ROADS AND BRIDGES (DMRB OR AS AGREED WITH LOCAL AUTHORITY).
  7. WHERE PROPOSED ROAD MARKINGS ARE SHOWN THE EXISTING ROAD MARKINGS ARE TO BE REMOVED AS APPROPRIATE.

**KEY:**

- DEVELOPMENT SITE BOUNDARY
- EXISTING LAY BY
- PROPOSED ROAD MARKING

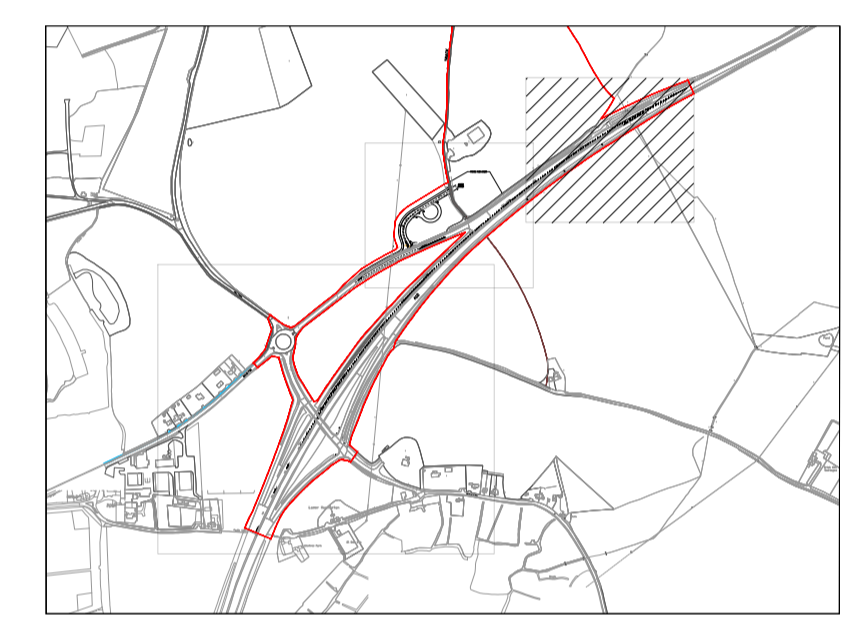

REVISION	DATE	DRAWN/CHECKED	REASONS FOR REVISION / COMMENTS	APPROVED	
01	FEB 2020	DHP	HWP	DCO SUBMISSION	SZC Co

**NOT PROTECTIVELY MARKED**

**COPYRIGHT:**  
 Reproduced from Ordnance Survey map with the permission of Ordnance Survey on behalf of the controller of Her Majesty's Stationery Office © Crown copyright (2019). All Rights reserved. NNB GenCo Licence: 0100060408



**PROJECT:**  
 SIZEWELL C

**DOCUMENT:**  
 APPLICATION DRAWING - FOR APPROVAL REGULATION 5(2)(o)

**DRAWING TITLE:**  
 SOUTHERN PARK AND RIDE HIGHWAY PROPOSED GENERAL ARRANGEMENT SHEET 3 OF 3

<b>DRAWING NO:</b> SZC-SZ0204-XX-000-DRW-100528	<b>REVISION:</b> 01
<b>DATE:</b> FEB 2020	<b>DRAWN:</b> DHP
<b>SCALE:</b> 1:500 @ A1	

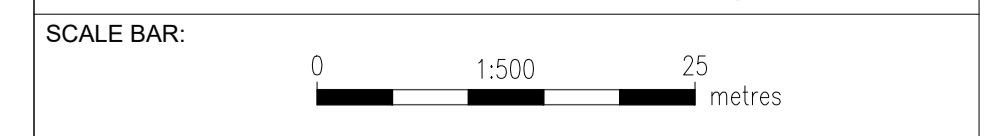

**NOTES:**

1. Do not scale from this drawing. All dimensions are in metres unless noted otherwise.
2. All levels are in metres Above Ordnance Datum (AOD).

**KEY:**

- DEVELOPMENT SITE BOUNDARY
- EXISTING
- - - PROPOSED
- - - REINSTATEMENT
- GL GROUND LEVEL
- AOD ABOVE ORDANCE DATUM

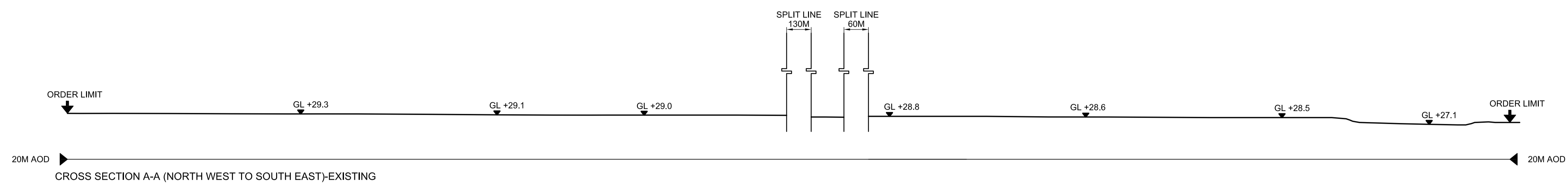

CROSS SECTION A-A (NORTH WEST TO SOUTH EAST)-EXISTING

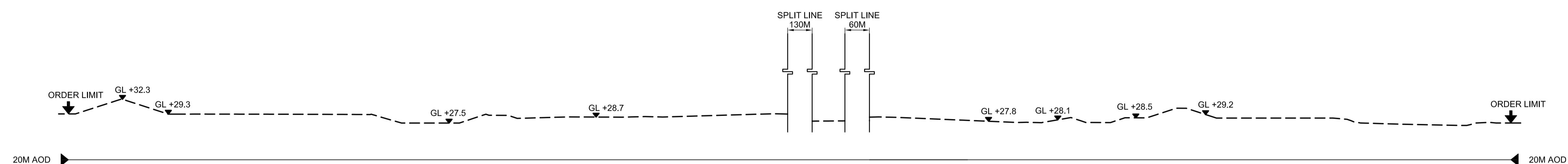

CROSS SECTION A-A (NORTH WEST TO SOUTH EAST)-PROPOSED

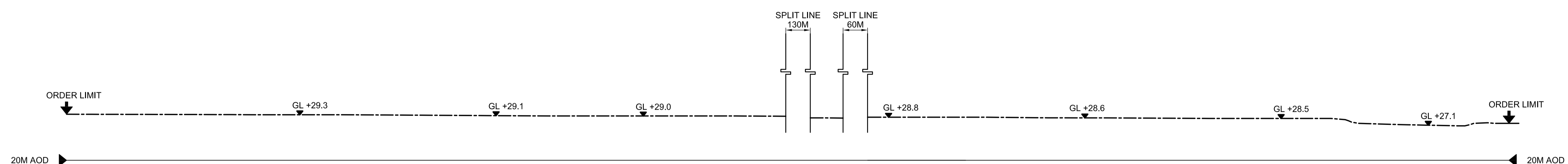

CROSS SECTION A-A (NORTH WEST TO SOUTH EAST)-REINSTATEMENT

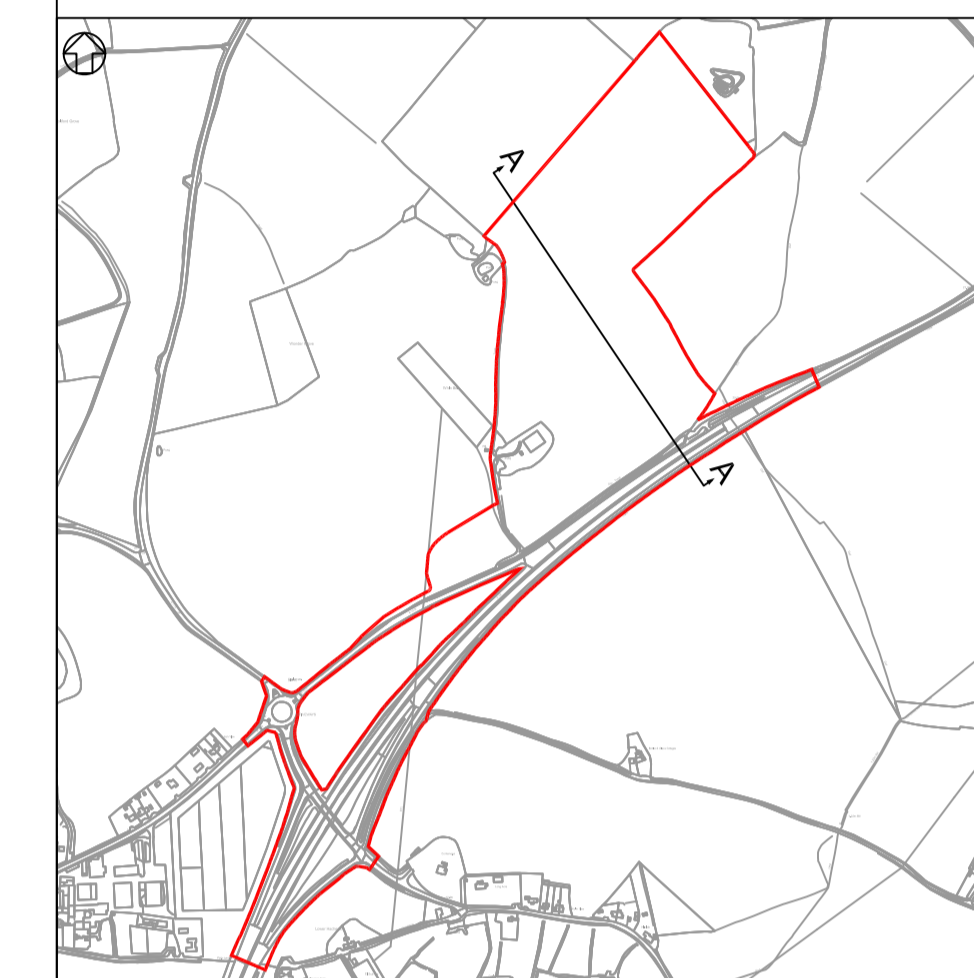

SITE CROSS SECTIONS LOCATION PLAN  
N.T.S.

REVISION	DATE	DRAWN	CHECKED	DCO SUBMISSION	REASONS FOR REVISION / COMMENTS	APPROVED
01	FEB 2020	NKS	KA	DCO SUBMISSION		PJ

NOT PROTECTIVELY MARKED

**COPYRIGHT:**

Reproduced from Ordnance Survey map with the permission of Ordnance Survey on behalf of the controller of Her Majesty's Stationery Office © Crown copyright (2019). All Rights reserved. NNB GenCo Licence: 0100060408



PROJECT:  
SIZEWELL C

DOCUMENT:  
APPLICATION DRAWING - NOT FOR APPROVAL  
REGULATION 5(2)(c)

DRAWING TITLE:  
SOUTHERN PARK AND RIDE  
EXISTING AND PROPOSED CROSS SECTIONS  
SHEET 1 OF 4

DRAWING NO:  
SZC-SZ0204-FP-000-DRW-100082

REVISION:  
01

DATE:  
FEB 2020

DRAWN:  
NKS

SCALE:  
1:500@A1

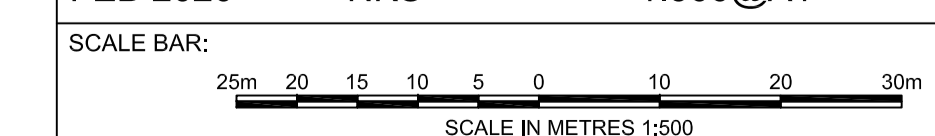

**NOTES:**

1. Do not scale from this drawing. All dimensions are in metres unless noted otherwise.
2. All levels are in metres Above Ordnance Datum (AOD).

**KEY:**

- DEVELOPMENT SITE BOUNDARY
- EXISTING
- - - PROPOSED
- · - REINSTATEMENT
- GL GROUND LEVEL
- AOD ABOVE ORDNANCE DATUM

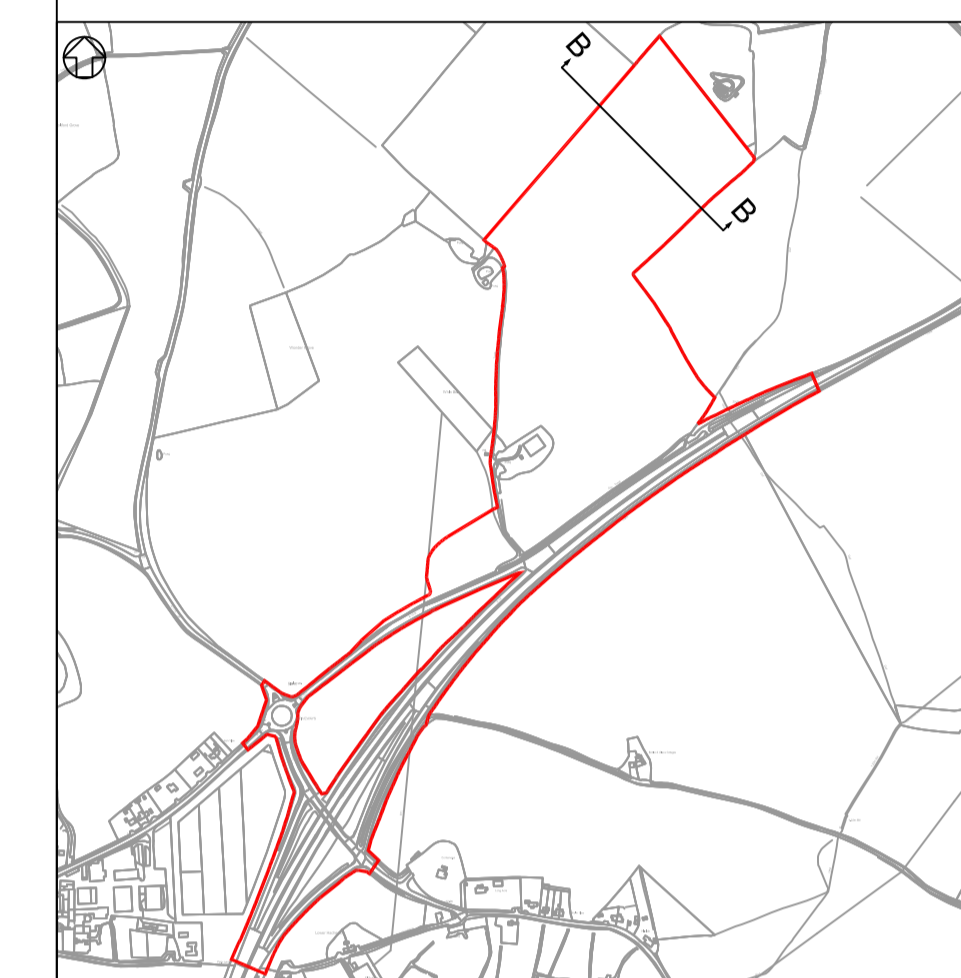
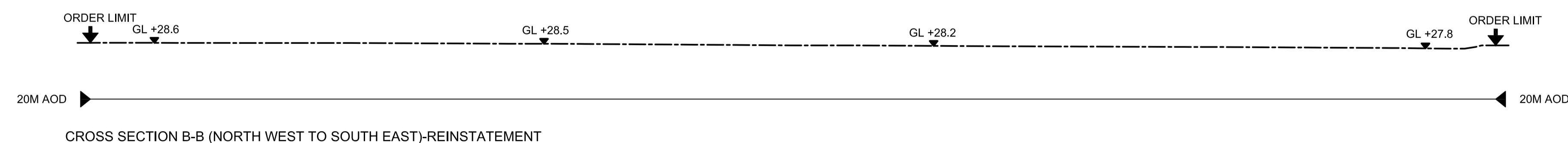
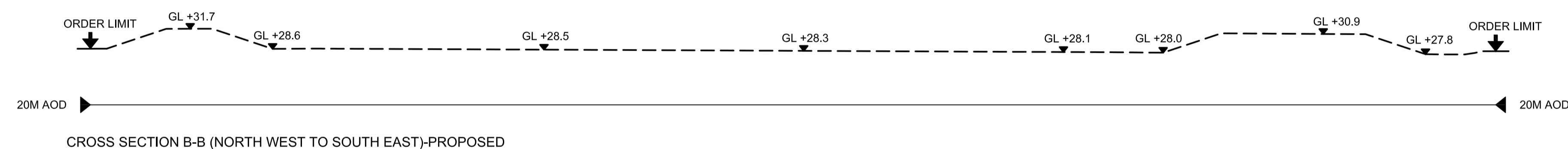
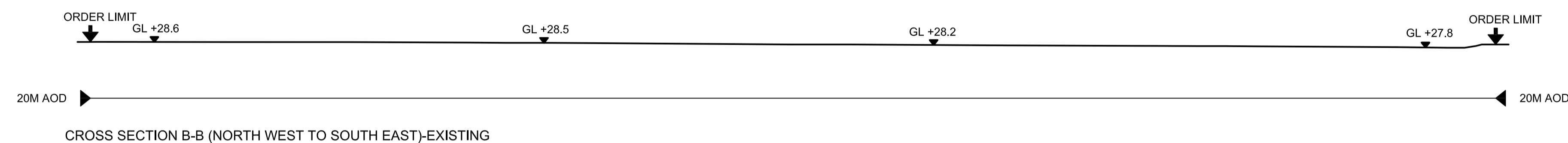

SITE CROSS SECTIONS LOCATION PLAN  
N.T.S.

01	FEB 2020	NKS	KA	DCO SUBMISSION	PJ
REVISION	DATE	DRAWN	CHECKED	REASONS FOR REVISION / COMMENTS	APPROVED

NOT PROTECTIVELY MARKED

**COPYRIGHT:**  
Reproduced from Ordnance Survey map with the permission of Ordnance Survey on behalf of the controller of Her Majesty's Stationery Office © Crown copyright (2019). All Rights reserved. NNB GenCo Licence: 0100060408



PROJECT:  
SIZEWELL C

DOCUMENT:  
APPLICATION DRAWING - NOT FOR APPROVAL  
REGULATION 5(2)(c)

DRAWING TITLE:  
SOUTHERN PARK AND RIDE  
EXISTING AND PROPOSED CROSS SECTIONS  
SHEET 2 OF 4

DRAWING NO: SZC-SZ0204-FP-000-DRW-100083 REVISION: 01

DATE: FEB 2020 DRAWN: NKS SCALE: 1:500@A1

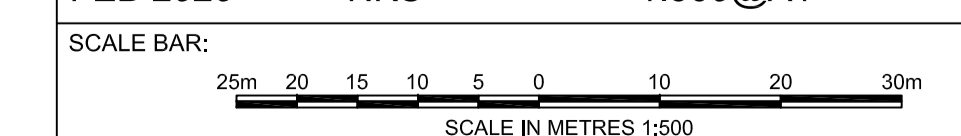

**NOTES:**

1. Do not scale from this drawing. All dimensions are in metres unless noted otherwise.
2. All levels are in metres Above Ordnance Datum (AOD).

**KEY:**

- DEVELOPMENT SITE BOUNDARY
- EXISTING
- - - PROPOSED
- · - · - REINSTATEMENT
- GL GROUND LEVEL
- AOD ABOVE ORDNANCE DATUM

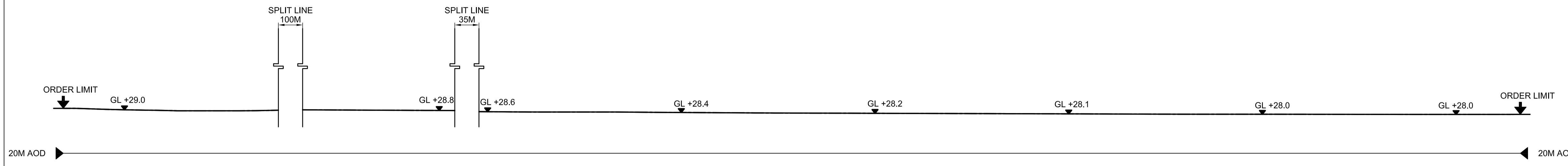

CROSS SECTION C-C (SOUTH WEST TO NORTH EAST)-EXISTING

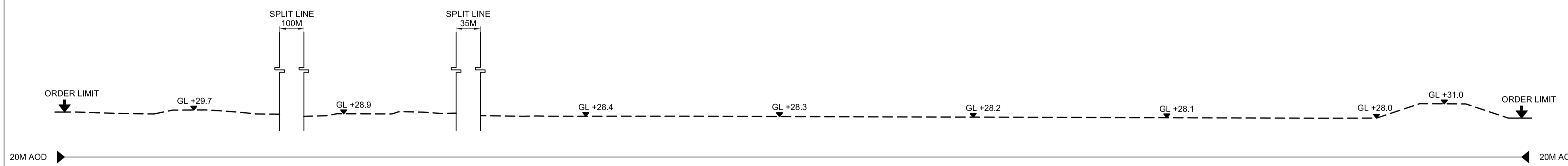

CROSS SECTION C-C (SOUTH WEST TO NORTH EAST)-PROPOSED

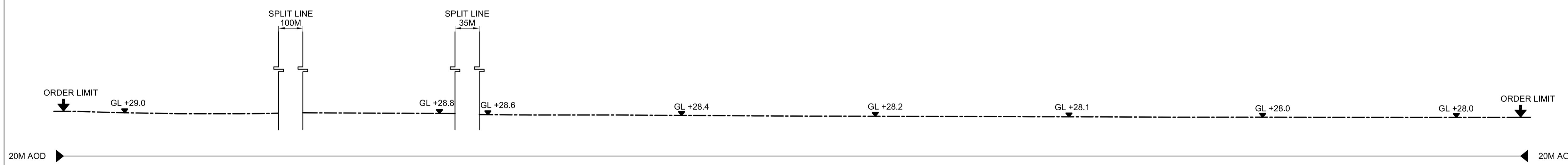

CROSS SECTION C-C (SOUTH WEST TO NORTH EAST)-REINSTATEMENT

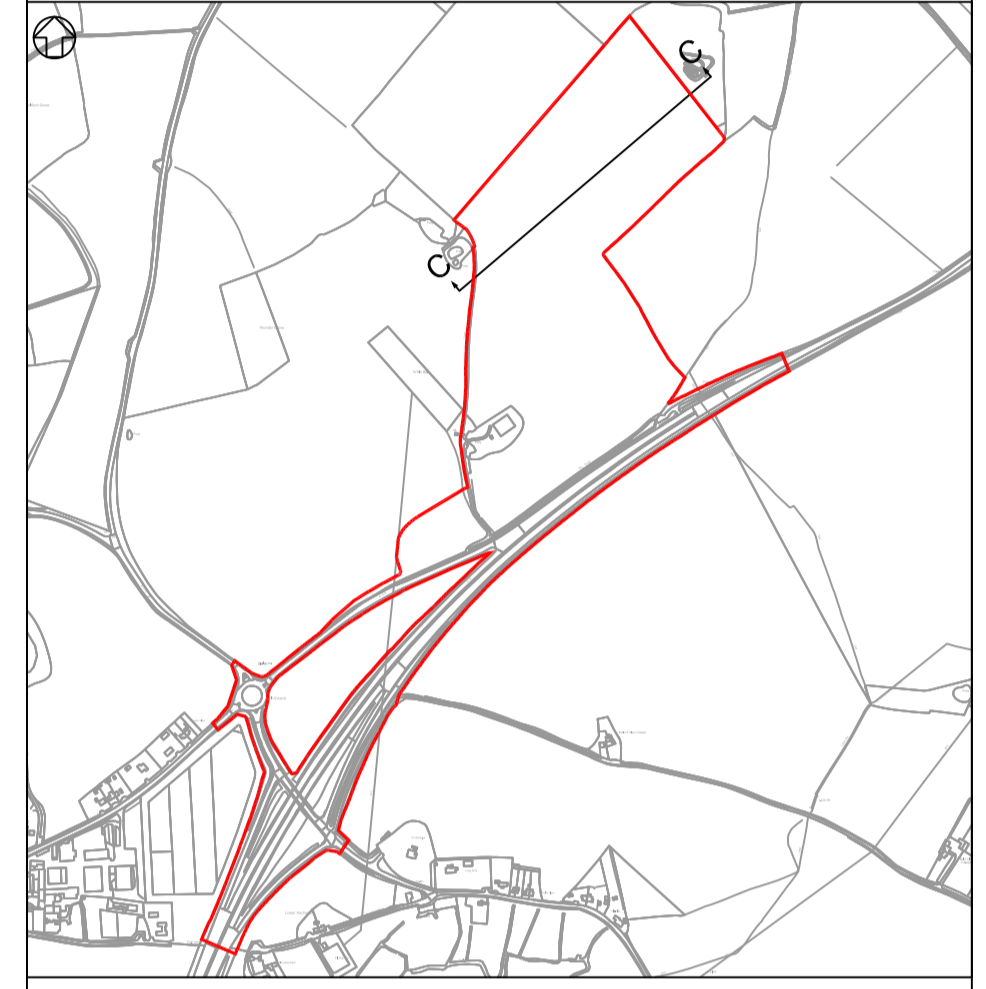

SITE CROSS SECTIONS LOCATION PLAN  
N.T.S.

REVISION	DATE	DRAWN/CHECKED	REASONS FOR REVISION / COMMENTS	APPROVED
01	FEB 2020	NKS KA	DCO SUBMISSION	PJ

NOT PROTECTIVELY MARKED

**COPYRIGHT:**

Reproduced from Ordnance Survey map with the permission of Ordnance Survey on behalf of the controller of Her Majesty's Stationery Office © Crown copyright (2019). All Rights reserved. NNB GenCo Licence: 0100060408



PROJECT:  
SIZEWELL C

DOCUMENT:  
APPLICATION DRAWING - NOT FOR APPROVAL  
REGULATION 5(2)(o)

DRAWING TITLE:  
SOUTHERN PARK AND RIDE  
EXISTING AND PROPOSED CROSS SECTIONS  
SHEET 3 OF 4

DRAWING NO: SZC-SZ0204-FP-000-DRW-100084 REVISION: 01

DATE: FEB 2020 DRAWN: NKS SCALE: 1:500@A1

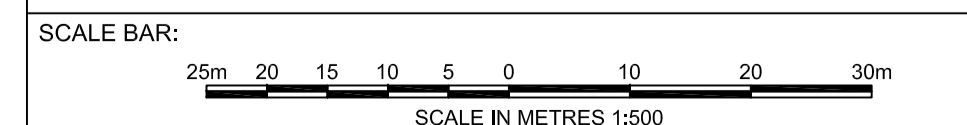

**NOTES:**

1. Do not scale from this drawing. All dimensions are in metres unless noted otherwise.
2. All levels are in metres Above Ordnance Datum (AOD).

**KEY:**

**KEY**

- DEVELOPMENT SITE BOUNDARY
- EXISTING
- - - PROPOSED
- · - REINSTATEMENT
- GL GROUND LEVEL
- AOD ABOVE ORDNANCE DATUM

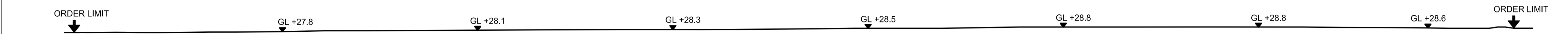

CROSS SECTION D-D (SOUTH WEST TO NORTH EAST)-EXISTING

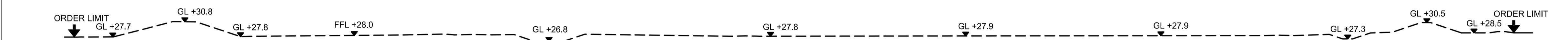

CROSS SECTION D-D (SOUTH WEST TO NORTH EAST)-PROPOSED

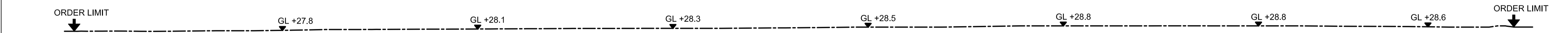

CROSS SECTION D-D (SOUTH WEST TO NORTH EAST)-REINSTATEMENT

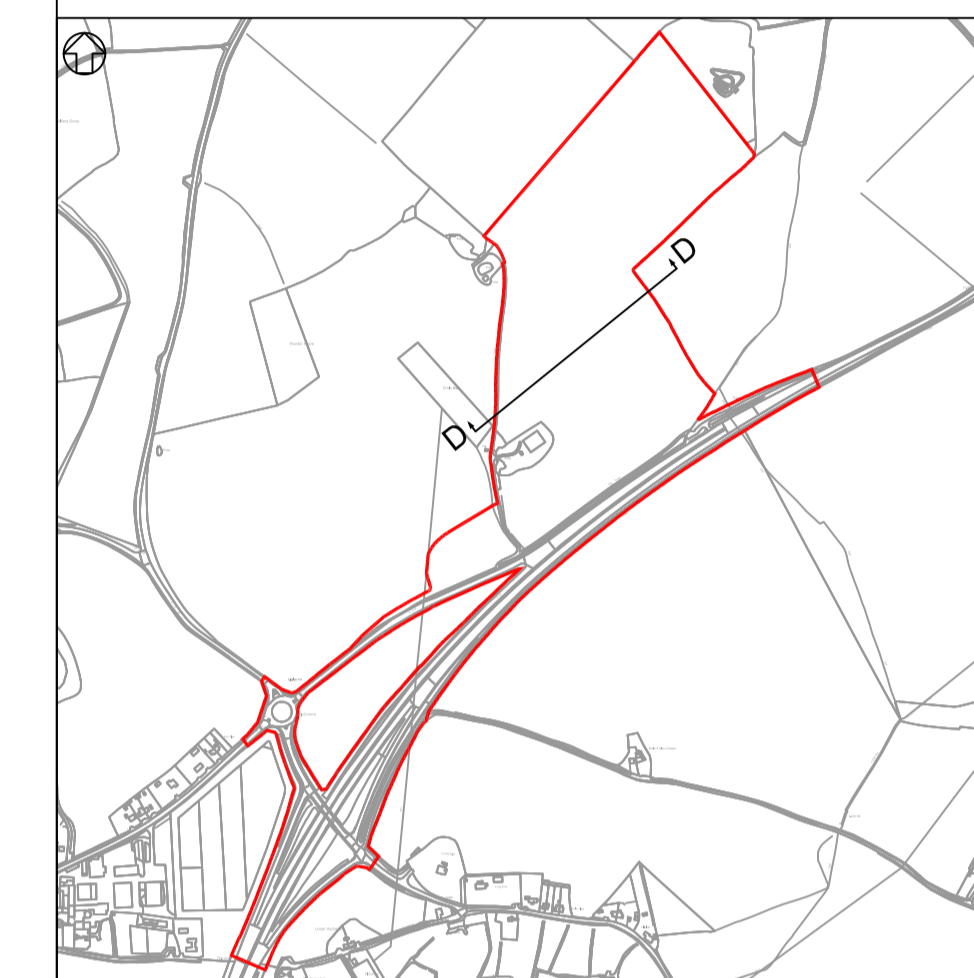

SITE CROSS SECTIONS LOCATION PLAN  
N.T.S.

REVISION	DATE	DRAWN/CHECKED	REASONS FOR REVISION / COMMENTS	APPROVED
01	FEB 2020	NKS KA	DCO SUBMISSION	PJ

NOT PROTECTIVELY MARKED

**COPYRIGHT:**

Reproduced from Ordnance Survey map with the permission of Ordnance Survey on behalf of the controller of Her Majesty's Stationery Office © Crown copyright (2019). All Rights reserved. NNB GenCo Licence: 0100060408



PROJECT:  
SIZEWELL C

DOCUMENT:  
APPLICATION DRAWING - NOT FOR APPROVAL  
REGULATION 5(2)(c)

DRAWING TITLE:  
SOUTHERN PARK AND RIDE  
EXISTING AND PROPOSED CROSS SECTIONS  
SHEET 4 OF 4

DRAWING NO:  
SZC-SZ0204-FP-000-DRW-100085

REVISION:  
01

DATE:  
FEB 2020

DRAWN:  
NKS

SCALE:  
1:500@A1

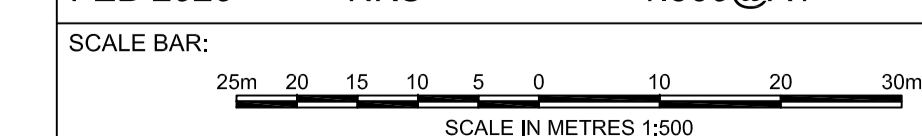

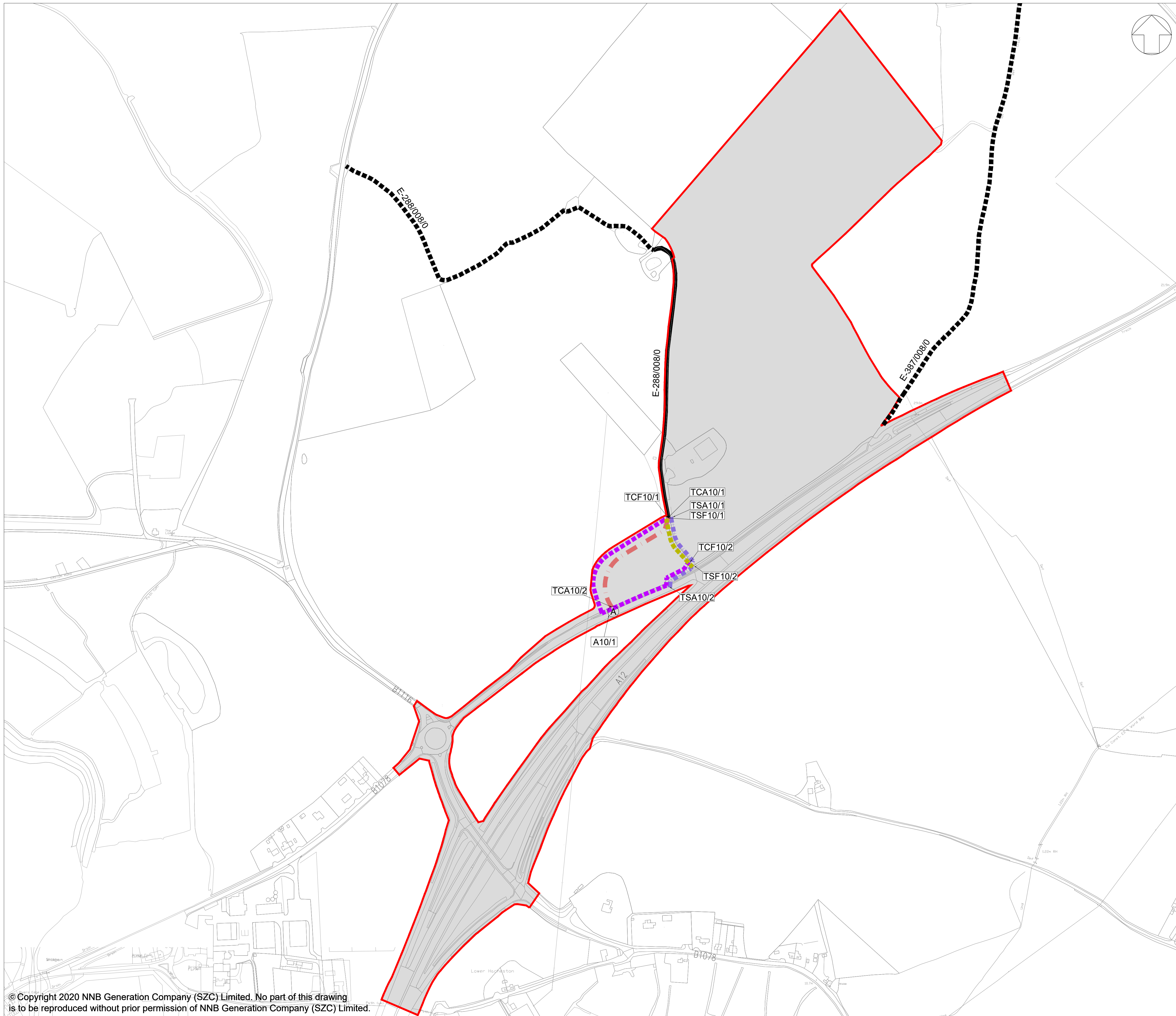

**NOTES:**

ALL FOOTPATHS, CYCLEPATHS, BRIDLEWAYS, BYWAYS AND RESTRICTED BYWAYS ARE REFERRED TO AS FOOTPATHS.

ALL PUBLIC HIGHWAYS, INCLUDING THESE WITH ADJACENT FOOTWAYS AND CYCLEWAYS, SHOWN ON THIS DRAWING ARE REFERRED TO AS HIGHWAY.

**KEY:**

- ORDER LIMITS
- EXISTING FOOTPATH TO BE RETAINED
- EXISTING FOOTPATH AND PRIVATE MEANS OF ACCESS TO BE RETAINED
- INDICATIVE ROUTE OF NEW TEMPORARY FOOTPATH
- TEMPORARY STOPPING UP OF FOOTPATH
- TEMPORARY EXTINGUISHMENT OF PRIVATE MEANS OF ACCESS
- INDICATIVE ROUTE OF NEW TEMPORARY PRIVATE MEANS OF ACCESS
- NEW OR ALTERED POINT OF ACCESS
- TSF\*/\* POINT OF COMMENCEMENT OR TERMINATION OF TEMPORARY STOPPING UP OF FOOTPATH
- TSA\*/\* POINT OF COMMENCEMENT OR TERMINATION OF TEMPORARY EXTINGUISHMENT OF PRIVATE MEANS OF ACCESS
- TCF\*/\* POINT OF COMMENCEMENT OR TERMINATION OF TEMPORARY CREATION OF FOOTPATH
- TCA\*/\* POINT OF COMMENCEMENT OR TERMINATION OF TEMPORARY CREATION OF PRIVATE MEANS OF ACCESS

01	FEB 2020	M.W.	ES	DCO SUBMISSION	SZC Co
REVISION	DATE	DRAWN/CHECKED		REASONS FOR REVISION / COMMENTS	APPROVED

NOT PROTECTIVELY MARKED

**COPYRIGHT:**

Reproduced from Ordnance Survey map with the permission of Ordnance Survey on behalf of the controller of Her Majesty's Stationery Office © Crown copyright (2019). All Rights reserved. NNB GenCo Licence: 0100060408



PROJECT:  
SIZEWELL C

DOCUMENT:  
RIGHTS OF WAY PLANS  
REGULATION 5(2)(K)

DRAWING TITLE:  
SOUTHERN PARK AND RIDE  
RIGHTS OF WAY PLANS - SHEET 16 OF 27

DRAWING NO:  
SZC-SZ0204-XX-000-DRW-100335

REVISION:  
01

DATE: FEB 2020      DRAWN: M.W.      SCALE: 1:2,500 @ A1

